

# HAVACO®

## PRODUCT CATALOGUE







































**HAVACO**<sup>®</sup> | HEATING  
VENTILATION  
AIR CONDITIONING

# **PRODUCT CATALOGUE**

**PRODUCTS FOR VENTILATION AND AIR CONDITIONING**

The information and photos presented are for informational and illustrative purposes only. Due to the continuous development of products, Ventia Sp. z o.o. reserves the right to introduce changes to the content, illustrations, colors, technical data and elements described and presented in this catalogue at any time, without prior notice. The catalogue was up-to-date at the time of printing. Copying the content of the catalogue without the consent of Ventia Sp. z o.o. is prohibited.

## Products for ventilation installations

 Round spiral duct (spiro type) RZS page 10	 Pressed bends B page 11
 Pressed bends with gasket BX page 12	 Segmented bends BS page 13
 Segmented bends with gasket BSX page 15	 Pressed reducer without gasket RC page 17
 Pressed reducer with gasket RCX page 17	 Pressed reducer without gasket M/F RCF page 18
 Pressed reducer with gasket M/F RCFX page 18	 Segmented reducer without gasket RCS page 19
 Segmented reducer with gasket RCXS page 20	 Pressed collar saddle, without gasket PS page 21
 Pressed collar saddle, with gasket PSX page 22	 T-piece without gasket TB page 23
 T-piece with gasket TX page 25	 Y-piece without gasket YB page 27
 Male coupling VB, Female coupling VFB page 28	 Male coupling with gasket VX page 29
 Take-off ILB page 30	 Take-off ILRB page 30
 Take-off with gasket ILX page 31	 End cap for duct D, Dual end cap M/F DDF page 32
 End cap with gasket DX page 33	 Take-off with mesh ILGB page 34
 Single blade damper DSCB page 35	 Single blade damper with gasket DSCX page 36
 Shut-off single blade damper with plate for actuator DSLXMP page 37	 Round roof intake and exhaust ORR page 39
 Cylindrical air exhaust-er FRR page 39	 Round roof base BRR page 40
 Backdraft damper RSKV page 41	 Damper with flow meter IRIS page 42

## Products for ventilation installations

 Air valves EV, SV page 44	 Air valves SV-SC, EV-SC page 49
 Air valve VSE page 51	 Square diffusers RA40 page 52
 Plenum boxes PB-RA40 page 53	 Swirl diffusers SAC page 54
 Plenum boxes PB-SA-C page 56	 Swirl diffusers SA-B page 57
 Plenum boxes PB-SA-B page 58	 Swirl diffuser SW page 59
 Circular diffuser CA page 60	 Circular mounting connector CA-P page 61
 Linear slot diffuser LD page 62	 Egg crate EGC page 64
 Jet nozzle diffuser JN-S page 65	 Grill for round duct SGD page 66
 Flexible insulated duct IZOFLEX PRO page 67	 Flexible duct without insulation ALUFLEX 3.0 page 68
 Semi-flexible duct without insulation SEMIFLEX page 69	 Circular acoustic silencer TAO page 70
 Flexible acoustic silencer AKUFLEX page 71	 Flexible acoustic silencer AKUDEC page 72
 Flexible acoustic silencer with thermal insulation GREENDEC® Sanitized® page 73	 Air intake/exhaust KVOV page 75
 Air intake/exhaust VLAV page 76	 Air intake/exhaust vent VLBV page 76
 Air intake/exhaust ELAV page 77	 Air intake TRAPEZOIDAL page 78
 Air outlet TRAPEZOIDAL TREND page 79	 Air intake SOFFIT page 80
 Anti-vibration connectors for fans with rectangular connection REC page 81	 Fastening clamp PCC page 81
 Rectangular duct silencer RDA page 82	 Filter G3 for round ducts FKOV page 83

## Products for ventilation installations

 Access door for rectangular ducts VFAD page 84	 Access door for round ducts VCAD page 85
 Mounting bracket with gasket CRDG page 86	 Flexible connector HCV page 87
 Rubber mat MKV PRO page 87	 Roof foot FLEXO FOOT page 88
 Mounting profile STU page 88	 End cap for mounting profile Z-STU page 89
 Shock absorber/gasket for mounting profile GA page 89	 Galvanised bolt BB page 89
 Galvanised steel nut NN page 89	 Galvanised, enlarged round washer WWW page 89
 Galvanised washer WW page 89	 Two-thread bolt VDF page 89
 Dowel page 89	 Console T page 90
 Mounting console with bracket TKO page 90	 Cantilever arm FT page 90
 Threaded rods PGI page 91	 Beam clamp for threaded rod HBV page 91
 Coupling nut NBV page 91	 Drop-in anchor TKV page 91
 Duct band clamp and clamps CFB, CFC page 91	 Nylon band CFN page 91
 Steel band CFS page 92	 Perforated band DPH page 92
 Flange profile PK page 92	 Flange profile corner NV page 92
 G-Clamp GCV page 92	 Slide-in profile PWQ page 93
 Gasket PES page 93	 Mounting brackets Z, L, V page 93

## Products for ventilation installations

 Discs for steel cut TCS page 93	 Self-drilling screws SSD-C page 94
 Screws tip SSD page 94	 Self-drilling screws SSD-IM page 94
 Self-drilling screws SSD-H page 94	 Aluminium tape ATSS page 96
 Reinforced aluminium tape ATSE page 95	 Metallized tape ATPP page 96
 Grey textile tape TTS page 96	 White textile tape TTB page 96
 Black textile tape TTC page 96	 Mounting tape PVC PVCT page 96
 Zinc spray for ventilation ducts page 97	 Soudal Acryrub grey acryl page 97
 Grey silicone TIGER page 97	 Mounting foam TIGER page 97

## Flexo System - residential distribution system

 Flexible duct FLEXO DUCT SPECTRA 1000 page 100	 Flexible duct FLEXO DUCT STANDARD page 101
 Plenum box FLEXO BOX PRO T page 102	 Insulated manifolds FLEXO BOX PRO P page 104
 1-row angle insulated manifolds FLEXO BOX PRO K page 106	 Linear insulated manifolds FLEXO BOX PRO L page 108
 Flat manifolds for self-configuration FLEXO MODULE SYSTEM page 112	 Flat duct bypass FLEXO PRO BYPASS page 112
 Silencing damper FLEXO DAMPER page 112	 Flexible duct mounting FLEXO HOLDER page 112
 Box end cap FLEXO END page 112	 Duct link FLEXO LINK PRO page 112
 Corrugated duct cutter FLEXO CUTTER page 112	 Silicone spray FLEXO SPRAY page 113

## Bathroom fans



COMO  
Silent  
page 115

COMO  
Design / QD  
page 116

## Duct fans and Kitchen fans



ICB  
page 117

ICM  
page 120

ICM EC  
page 122



ICMsilent  
page 124

IRB  
page 126

IKB  
page 129

## Roof fans



RBH  
page 131

RCM  
page 134

RKH  
page 136



RKV  
page 137

RBV  
page 139

RAH  
page 142

## Axial fans



AM6  
page 145

AP6  
page 148

## Radial fans

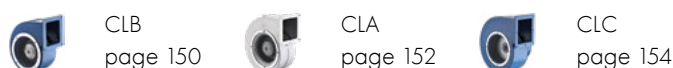

CLB  
page 150

CLA  
page 152

CLC  
page 154

## Electric heaters for round ducts



ECH  
page 156

ECH NI/  
NV/NIS  
page 158

ECH NI  
PTX/PSX  
page 160

## Electric heaters for rectangular ducts



ERH  
page 169

ERH NV/NI/NIS  
page 171

## Accessories for fans and electric heaters



Accessories for fans and electric heaters  
page 173

## Products for air conditioning installations



Insulated copper pipe  
HAVACO ColdLine Pro  
page 179

Wall bracket with  
crossbar MSH  
page 180

## Products for air conditioning installations



The condenser mounting  
MS  
page 181

The condenser mounting  
with a crossbar  
MS  
page 182

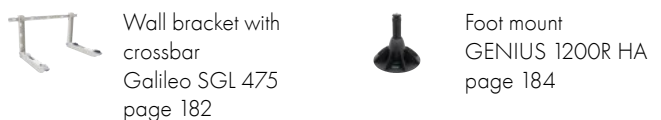

Wall bracket with  
crossbar  
Galileo SGL 475  
page 182

Foot mount  
GENIUS 1200R HA  
page 184



Foot mount  
GENIUS 1200R  
page 185

Floor support  
Hercules  
page 186

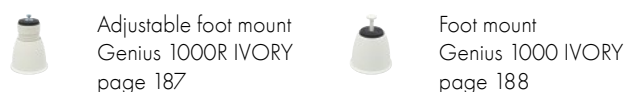

Adjustable foot mount  
Genius 1000R IVORY  
page 187

Foot mount  
Genius 1000 IVORY  
page 188



Condensate pump  
EASY FLOW  
page 189

PVC base for con-  
denser ADF  
page 191



End cap for PVC  
base for condenser  
PVC342TS  
page 191

Rubber base RB  
page 191



Floor mounts SP510  
page 191

Anti-vibration feet  
FVDCO M8  
page 191



Reducing connector for  
condensate drain CCSR  
page 191

Corrugated conden-  
sate pipe TU  
page 192



Reinforced conden-  
sate pipe  
page 192

Condensate pipe  
page 192



Condenser ball trap  
HL136  
page 192

Vertical/horizontal  
trap  
page 192



Flush-mounted trap  
HL138  
page 193

Condensate pump  
MINI ORANGE  
page 193

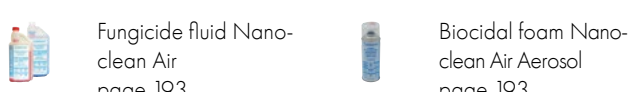

Fungicide fluid Nano-  
clean Air  
page 193

Biocidal foam Nano-  
clean Air Aerosol  
page 193



Cleaner and  
degreaser ACTIVE  
Concentrate  
page 194

Cleaner and  
degreaser POWER  
Concentrate  
page 194



## Products for air conditioning installations



Cleaner and  
degreaser ACTIVE  
Foam  
page 194



Installation trough  
PVC ODF 80, ADF 80  
page 195



Connecting strap  
PVC, tray connector  
ODC 80, CLC 80  
page 195



Trough end cap PVC  
ODEC 80, CLEC 80  
page 195



Wall-mounted cover  
PVC ODWC 80,  
CLWC 80  
page 195



Inner corner PVC  
ODIC 80, CLIC 80  
page 195



External corner PVC  
ODCO 80, CLCO 80  
page 196



T-piece PVC ODTJ 80,  
CLT 80  
page 196



Mounting bend PVC  
ODFE 80, CLFE 80  
page 196



Rosette ODWR 80,  
CLFR 80  
page 196

# B2B platform Ventia

comfortable and safe online shopping  
for business customer

ventia® | B2B

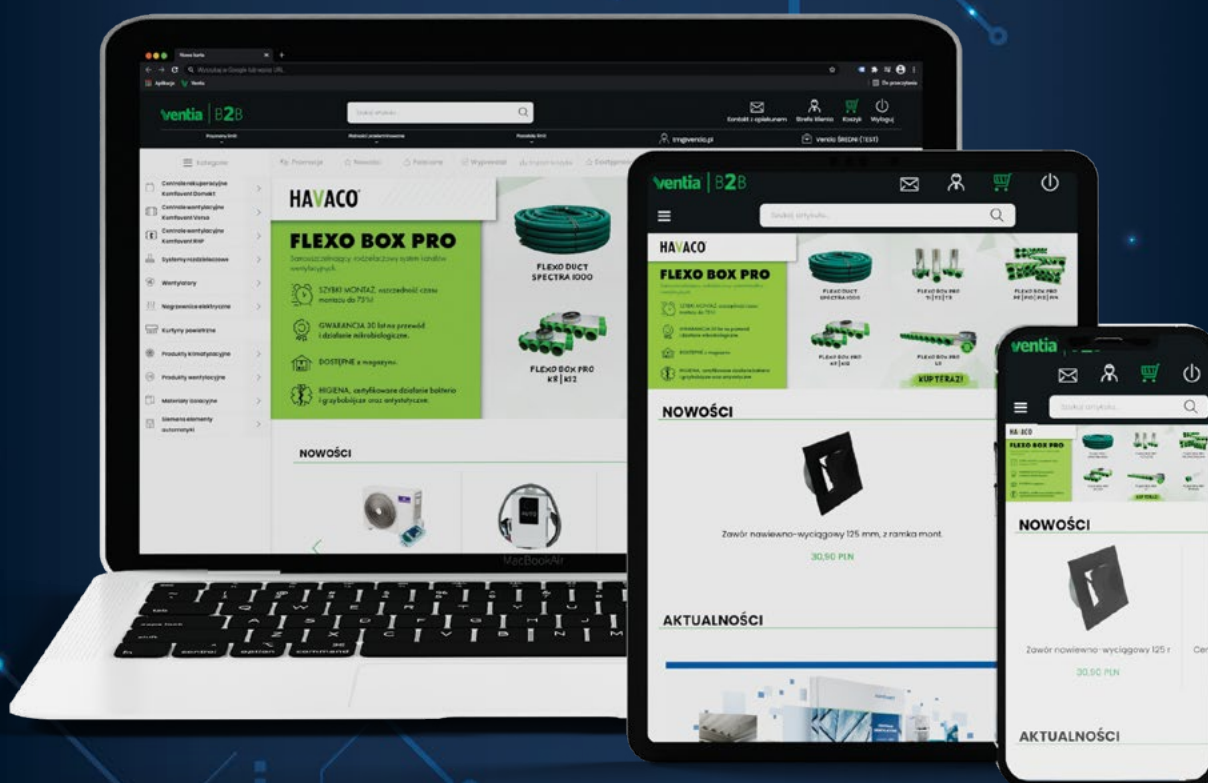

From any  
device



All products  
in one place



24h/ 7 days



Current warehouse  
stock levels



Individual cus-  
tomer account

Don't have access to the Ventia B2B platform yet?

**Please contact your sales representative.**



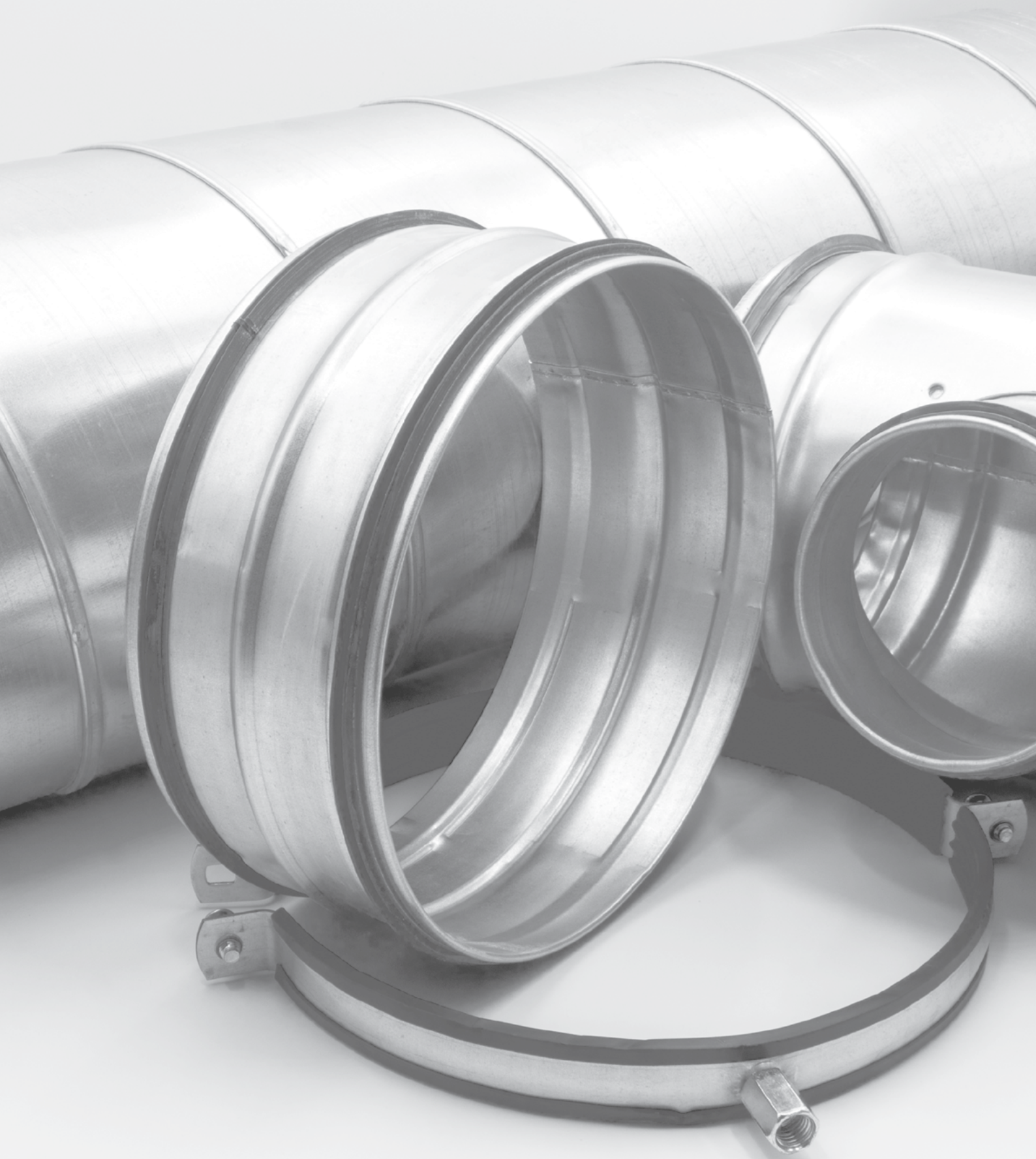



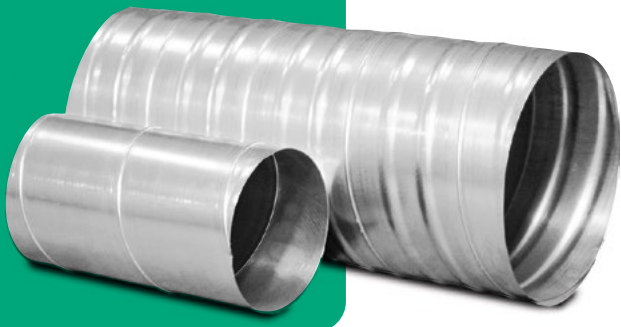

## Round spiral duct (spiro type) RZS



Additional reinforcing  
ridges



High quality  
steel and zinc



A wide  
range

### Description

Round spiral duct (spiro type). Available diameters from 80 mm to 1250 mm. Standard length 3 m. Made from galvanised steel sheet, compiled with EN 1506:2007 and EN 12237. Ducts from a diameter 250 mm are additionally strengthened with ribbing to increase their stiffness and resistance to negative pressure. Ducts with different lengths (e.g. 6, 9, 12 [m]), different sheet thickness, or made from different materials (acid resistant sheet 1.4301 and 1.4404) are available upon request.

### Technical drawing

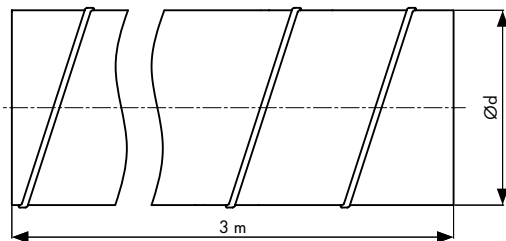

### Dimensions [mm]

ØD nom.	Sheet metal thickness	ØD nom.	Sheet metal thickness
80	0,4	450	0,5
100	0,4	500	0,6
125	0,4	560	0,6
150	0,4	630	0,75
160	0,4	710	0,75
200	0,4	800	0,75
250	0,4	900	0,9
315	0,4	1000	0,9
355	0,5	1120	0,9
400	0,5	1250	1,0

Other thickness on request

### Tolerance [mm]

Model	ØD min	ØD min max	Model	ØD min	ØD min max
80	80	80,5	450	450	451,1
100	100	100,5	500	500	501,1
125	125	125,5	560	560	561,2
150	150	150,6	630	630	631,2
160	160	160,6	710	710	711,5
200	200	200,7	800	800	801,6
250	250	250,8	900	900	902,0
315	315	315,9	1000	1000	1002,0
355	355	356,0	1120	1120	1122,5
400	400	401,0	1250	1250	1252,5

### Technical specifications

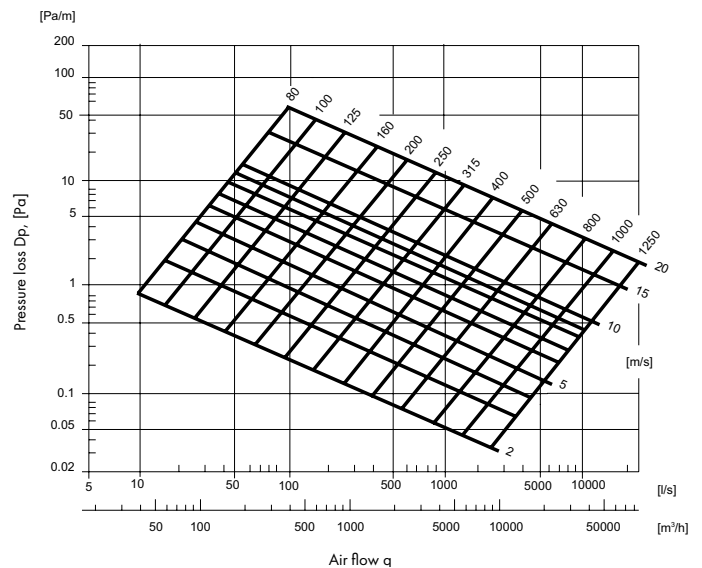





## Pressed bends B



Rounded, reinforced  
"SAFE" edges



Automatic linear  
welding



Top quality galvanized  
steel 275 g/m<sup>2</sup>

### Description

Pressed bends - "B" **SAFE**, are made from top quality galvanized steel (275 g/m<sup>2</sup>). Pressing process as well as linear welding are fully automatic. Rounded edges "SAFE", reinforced with curved rims, provide additional bend rigidity and safe mounting.

### Technical drawing

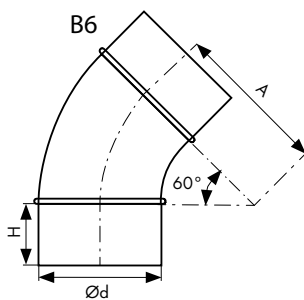
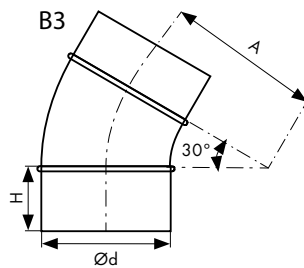
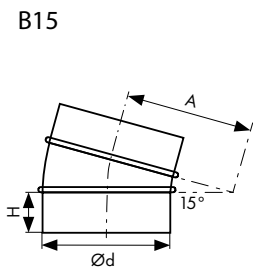
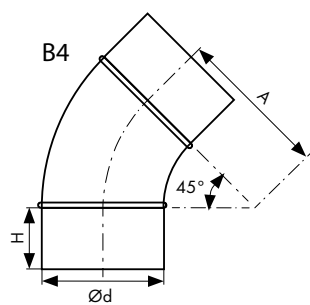
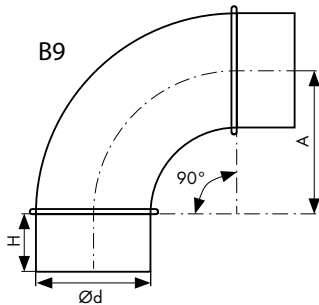

### Dimensions B9 [mm], Angle 90°

Ød nom.	A	H	kg	pcs/box	box type
80	100	40	0,27	85	P4
100	100	40	0,35	110	P2
125	125	40	0,52	60	P2
150	150	40	0,71	75	P1
160	160	40	0,83	60	P1
200	200	40	1,27	33	P1

### Dimensions B4 [mm], Angle 45°

Ød nom.	A	H	kg	pcs/box	box type
80	100	40	0,19	90	P6
100	100	40	0,24	90	P4
125	125	40	0,34	100	P2
150	150	40	0,44	60	P2
160	160	40	0,52	110	P1
200	200	40	0,77	60	P1

### Dimensions B15 [mm], Angle 15°

Ød nom.	A	H	kg	pcs/box	box type
80	100	40	0,2	54	P12
100	100	40	0,3	50	P12
125	125	40	0,3	28	P12
150	150	40	0,4	16	P12
160	160	40	0,5	15	P12
200	200	40	0,6	16	P6

### Dimensions B3 [mm], Angle 30°

Ød nom.	A	H	kg	pcs/box	box type
80	100	40	0,2	50	P12
100	100	40	0,3	75	P6
125	125	40	0,3	40	P6
150	150	40	0,4	25	P6
160	160	40	0,5	20	P6
200	200	40	0,7	16	P4

### Dimensions B6 [mm], Angle 60°

Ød nom.	A	H	kg	pcs/box	box type
80	100	40	0,3	80	P6
100	100	40	0,4	40	P6
125	125	40	0,5	22	P6
150	150	40	0,9	15	P6
160	160	40	1,0	20	P4
200	200	40	1,5	12	P4



Packaging method on page 38



## Pressed bends with gasket BX



Rounded, reinforced  
"SAFE" edges



Double gasket,  
tightness class D



Automatic linear  
welding



Top quality galvanised  
steel 275 g/m<sup>2</sup>

### Description

Pressed bends with gasket - "BX" **SAFE**, are made from top quality galvanised steel (275 g/m<sup>2</sup>). Pressing process as well as linear welding are fully automatic. With every edge "SAFE" type - reinforced with curved rims, provide additional bend rigidity and safe mounting. Double gasket EPDM clamped automatically ensure no risk of slipping during mounting. Product with **tightness class D**.

### Technical drawing

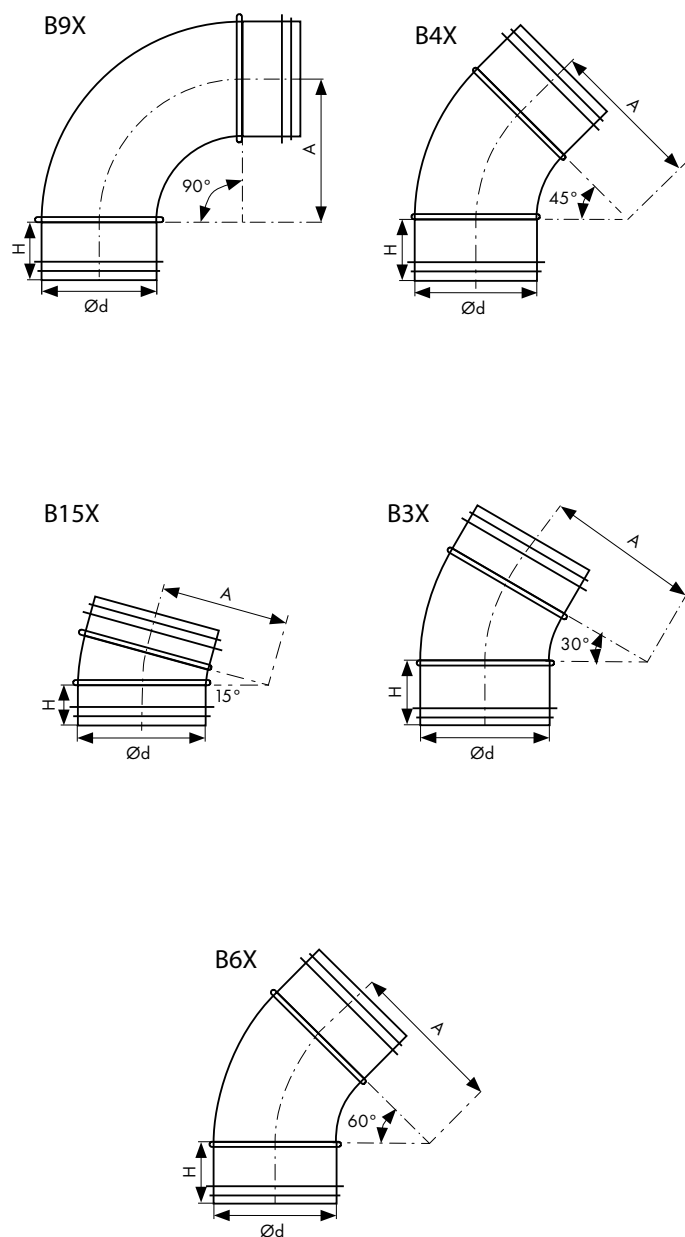

### Dimensions B9X [mm], Angle 90°

Ød nom.	A	H	kg	pcs/box	box type
80	100	35	0,27	85	P4
100	100	35	0,35	110	P2
125	125	35	0,52	60	P2
150	150	35	0,71	75	P1
160	160	35	0,83	60	P1
200	200	35	1,27	33	P1

### Dimensions B4X [mm], Angle 45°

Ød nom.	A	H	kg	pcs/box	pallet packaging
80	100	35	0,19	90	P6
100	100	35	0,24	90	P4
125	125	35	0,34	100	P2
150	150	35	0,44	60	P2
160	160	35	0,52	110	P1
200	200	35	0,77	60	P1

### Dimensions B15X [mm], Angle 15°

Ød nom.	A	H	kg	pcs/box	box type
80	100	35	0,2	54	P12
100	100	35	0,3	48	P12
125	125	35	0,3	27	P12
150	150	35	0,4	16	P12
160	160	35	0,5	16	P12
200	200	35	0,6	18	P6

### Dimensions B3X [mm], Angle 30°

Ød nom.	A	H	kg	pcs/box	box type
80	100	35	0,2	50	P12
100	100	35	0,3	75	P6
125	125	35	0,3	40	P6
150	150	35	0,4	25	P6
160	160	35	0,5	20	P6
200	200	35	0,7	16	P4

### Dimensions B6X [mm], Angle 60°

Ød nom.	A	H	kg	pcs/box	box type
80	100	35	0,3	85	P6
100	100	35	0,4	40	P6
125	125	35	0,5	22	P6
150	150	35	0,9	15	P6
160	160	35	1,0	20	P4
200	200	35	1,5	12	P4

 Packaging method on page 38



# Segmented bends BS



Automatic linear welding



Top quality galvanised steel 275 g/m<sup>2</sup>

## Description

Segmented bends - BS **VENTO**, are made from top quality galvanised steel (275 g/m<sup>2</sup>).

## Technical drawing

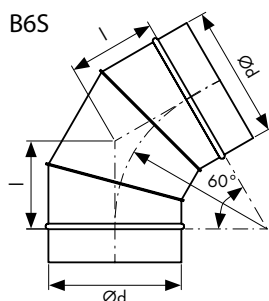
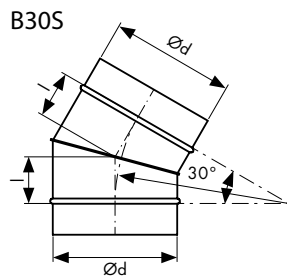
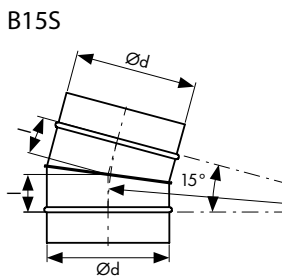
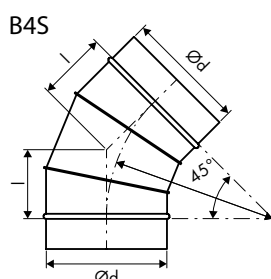
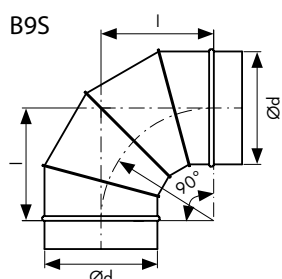

## Dimensions B9S [mm], Angle 90°

Ød nom	l	t	kg	pcs/box	box type
250	250	0,5	1,80	54	
315	315	0,5	2,60	28	layered packing + stretch film
355	355	0,5	3,30	21	
400	400	0,6	4,90	12	
450	450	0,6	6,00	-	-
500	500	0,7	8,70	-	on request
560	560	0,7	10,60	-	on request
630	630	0,7	14,10	-	on request
710	710	0,7	17,90	-	on request
800	800	0,7	21,50	-	on request
900	900	0,9	32,00	-	on request
1000	1000	0,9	46,10	-	on request

## Dimensions B4S [mm], Angle 45°

Ød nom	l	t	kg	pcs/box	box type
250	105	0,5	1,07	96	
315	130	0,5	1,55	48	layered packing + stretch film
355	145	0,5	1,86	42	
400	165	0,6	2,80	30	
450	185	0,6	3,67	-	-
500	205	0,7	5,28	-	on request
560	230	0,7	5,92	-	on request
630	260	0,7	7,25	-	on request
710	295	0,7	9,57	-	on request
800	330	0,7	11,35	-	on request
900	375	0,9	22,80	-	on request
1000	410	0,9	27,57	-	on request

## Dimensions B15S [mm], Angle 15°

Ød nom	l	t	kg	pcs/box	box type
250	35	0,5	0,64	25	P2
315	45	0,5	0,92	30	P1
355	50	0,5	0,99	20	P1
400	55	0,6	1,40	20	P1
450	60	0,6	2,30	-	-
500	70	0,7	3,43	-	-
560	75	0,7	3,96	-	-
630	85	0,7	4,79	-	-
710	95	0,7	6,43	-	on request
800	110	0,7	7,05	-	on request
900	120	0,9	8,20	-	on request
1000	135	0,9	10,50	-	on request



Packaging method on page 38

### Dimensions B3S [mm], Angle 30°

Ød nom	l	t	kg	pcs/box	box type
250	70	0,5	0,73	40	P1
315	85	0,5	1,17	10	P2
355	95	0,5	1,47	8	P2
400	110	0,6	2,03	10	P1
450	120	0,6	2,71	-	-
500	135	0,7	3,77	-	-
560	150	0,7	4,24	-	-
630	170	0,7	5,51	-	-
710	190	0,7	7,25	-	-
800	220	0,7	8,73	-	on request
900	240	0,9	16,96	-	on request
1000	270	0,9	20,36	-	on request

### Dimensions B6S [mm], Angle 60°

Ød nom	l	t	kg	pcs/box	box type
250	145	0,5	1,30	10	P2
315	185	0,5	1,80	10	P1
355	205	0,5	2,20	8	P1
400	235	0,6	3,20	4	P1
450	260	0,6	4,00	-	-
500	290	0,7	5,60	-	on request
560	325	0,7	6,80	-	on request
630	365	0,7	8,40	-	on request
710	410	0,7	14,00	-	on request
800	465	0,7	16,90	-	on request
900	520	0,9	19,10	-	on request
1000	580	0,9	24,00	-	on request



Packaging method on page 38





# Segmented bends with gasket BSX



Rounded, reinforced  
"SAFE" edges



Double gasket,  
tightness class D



Automatic linear  
welding



Top quality  
galvanised steel  
275 g/m<sup>2</sup>

## Description

Segmented bends with gasket - "BX" **SAFE**, are made from top quality galvanised steel (275 g/m<sup>2</sup>). With every edge "SAFE" type - reinforced with curved rims, provide additional bend rigidity and safe mounting. Double gasket EPDM clamped automatically ensure no risk of slipping during mounting. Product with **tightness class D**.

## Technical drawing

B9SX

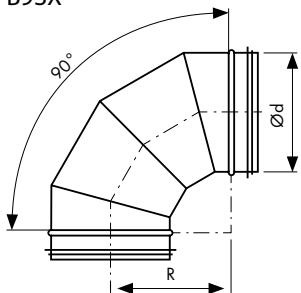

B4SX

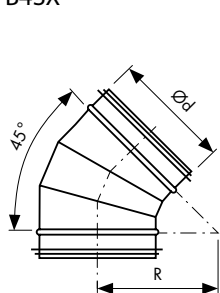

B15SX

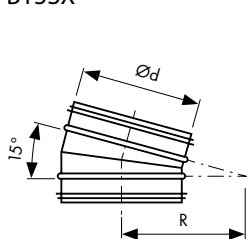

B3SX

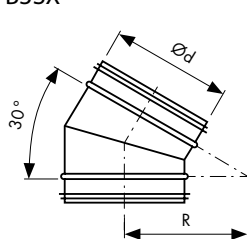

B6SX

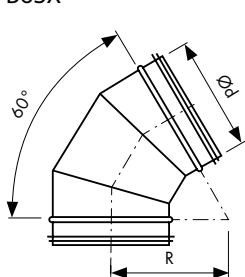

## Dimensions B9SX [mm], Angle 90°

Ød nom	R	H	kg	pcs/box	box type
250	250	45	0,69	25	
315	315	45	2,56	28	layered packing + stretch film
355	355	45	3,01	21	
400	400	45	3,85	12	
450	450	45	4,61	-	-
500	500	55	7,65	-	-
560	560	55	8,58	-	-
630	630	55	12,74	-	-
710	710	55	14,72	-	-
800	800	100	22,04	-	-
900	900	100	35,10	-	-
1000	1000	100	42,64	-	-

## Dimensions B4SX [mm], Angle 45°

Ød nom	R	H	kg	pcs/box	box type
250	250	50	1,07	96	
315	315	45	1,45	48	layered packing + stretch film
355	355	45	1,80	42	
400	400	45	2,25	30	
450	450	45	3,24	-	-
500	500	55	4,19	-	-
560	560	55	4,95	-	-
630	630	55	6,64	-	-
710	710	55	7,89	-	-
800	800	100	12,53	-	-
900	900	100	19,75	-	-
1000	1000	100	23,74	-	-

## Dimensions B15SX [mm], Angle 15°

Ød nom	R	H	kg	pcs/box	box type
250	250	45	0,69	1/25	-/P2
315	315	45	0,90	28	P1
355	355	45	0,90	28	P1
400	400	50	1,33	20	P1
450	450	70	1,7	-	-
500	500	70	2,81	-	-
560	560	70	3,69	-	-
630	630	70	4,32	-	-
710	710	70	5,37	-	-
800	800	100	6,05	-	-
900	900	100	9,69	-	-
1000	1000	100	10,86	-	-



Packaging method on page 38

### Dimensions B3SX [mm], Angle 30°

Ød nom	R	H	kg	pcs/box	box type
250	250	45	0,8	40	P1
315	315	45	1,06	1/10	-/P2
355	355	45	1,26	12	P1
400	400	45	1,48	10	P1
450	450	70	2,61	-	-
500	500	70	3,65	-	-
560	560	70	4,33	-	-
630	630	70	5,1	-	-
710	710	70	7,62	-	-
800	800	100	9,15	-	-
900	900	100	14,25	-	-
1000	1000	100	17,19	-	-

### Dimensions B6SX [mm], Angle 60°

Ød nom	R	H	kg	pcs/box	box type
250	250	45	1,17	20	P1
315	315	45	1,7	10	P1
355	355	45	2,07	8	P1
400	400	45	2,57	-	-
450	450	70	4,27	-	-
500	500	70	6,14	-	-
560	560	70	7,88	-	-
630	630	70	9,69	-	-
710	710	70	12,74	-	-
800	800	100	15,76	-	-
900	900	100	24,94	-	-
1000	1000	100	30,08	-	-



Packaging method on page 38



## Pressed reducer without gasket RC



Rounded, reinforced  
"SAFE" edges

## Pressed reducer with gasket RCX



Top quality  
galvanized steel  
275 g/m<sup>2</sup>



Double gasket,  
tightness class D

### Description

Pressed male reducer. Made from top quality galvanised steel (275 g/m<sup>2</sup>). Fully automated stamping process from one metal sheet. With every edge "SAFE" type - reinforced with curved rims, provide additional fitting rigidity and safe mounting. The version with gasket additionally includes double gasket EPDM clamped automatically - ensuring no risk of slipping during mounting. Product with tightness class D - every single bend undergoes air tightness test in the factory.

### Technical drawing RC

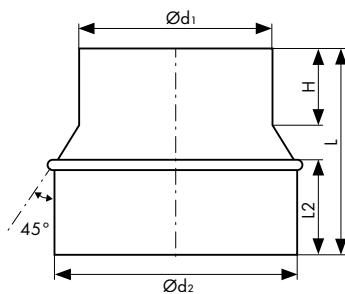

### Dimensions RC [mm]

Ød2 nom/Ød1 nom	L	H	L2	kg	pcs/box	box type
100 / 80	110	40	55	0,11	84	P12
125 / 80	122	40	55	0,16	63	P12
125 / 100	112	45	55	0,18	63	P12
160 / 80	135	40	40	0,40	60	P6
160 / 100	130	45	55	0,23	75	P6
160 / 125	117	45	55	0,21	75	P6
200 / 100	150	45	55	0,31	52	P6
200 / 125	137	45	55	0,30	56	P6
200 / 160	120	45	55	0,29	80	P4
250 / 160	144	45	55	0,42	90	P2
250 / 200	125	45	55	0,38	102	P2
315 / 160	177	45	55	0,63	52	P2
315 / 200	157	45	55	0,59	56	P2
315 / 250	132	45	55	0,52	65	P2
400 / 250	180	40	40	1,70	60	P1
400 / 315	150	40	40	1,91	24	P2

### Technical drawing RCX

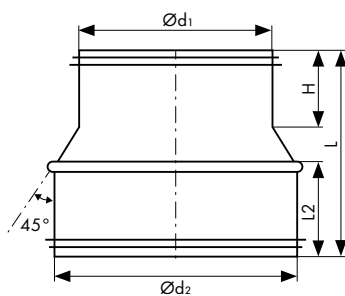

### Dimensions RCX [mm]

Ød2 nom/Ød1 nom	L	H	L2	kg	pcs/box	box type
100 / 80	100	35	50	0,11	84	P12
125 / 80	112	35	50	0,16	63	P12
125 / 100	102	40	50	0,16	63	P12
160 / 80	125	35	35	0,40	25	P12
160 / 100	120	40	50	0,23	60	P6
160 / 125	107	40	50	0,21	60	P6
200 / 100	140	40	50	0,31	42	P6
200 / 125	127	40	50	0,30	42	P6
200 / 160	110	40	50	0,50	75	P4
250 / 160	134	40	50	0,42	86	P2
250 / 200	115	40	50	0,38	90	P2
315 / 160	167	40	50	0,63	44	P2
315 / 200	147	40	50	0,59	56	P2
315 / 250	122	40	50	0,52	60	P2
400 / 250	170	35	35	1,78	45	P1
400 / 315	140	35	35	2,00	24	P2



Packaging method on page 38



## Pressed reducer without gasket M/F RCF



Rounded, reinforced  
"SAFE" edges



Top quality  
galvanised steel  
275 g/m<sup>2</sup>



Double gasket,  
tightness class D

### Description

Pressed male and female reducer. Made from top quality galvanised steel (275 g/m<sup>2</sup>). Fully automated stamping process from one metal sheet. With every edge "SAFE" type - reinforced with curved rims, provide additional fitting rigidity and safe mounting. The version with gasket additionally includes double gasket EPDM clamped automatically - ensuring no risk of slipping during mounting. Product with tightness class D - every single bend undergoes air tightness test in the factory.

### Technical drawing RCF

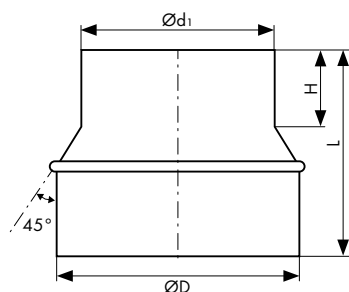

### Dimensions RCF [mm]

ØD nom/Ød1 nom	L	H	kg	pcs/box	box type
100 / 80	110	40	0,11	72	P12
125 / 80	122	40	0,16	63	P12
125 / 100	112	45	0,17	63	P12
160 / 100	130	45	0,23	60	P6
160 / 125	117	45	0,21	60	P6
200 / 100	150	45	0,31	52	P6
200 / 125	137	45	0,30	45	P6
200 / 160	120	45	0,29	75	P4
250 / 160	144	45	0,42	90	P2
250 / 200	125	45	0,38	96	P2
315 / 160	177	45	0,63	56	P2
315 / 200	157	45	0,59	60	P2
315 / 250	132	45	0,52	52	P2

### Technical drawing RCFX

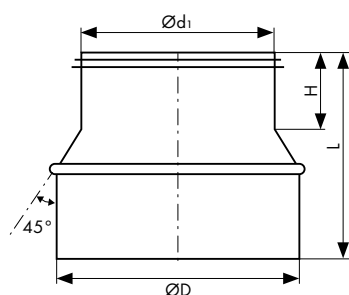

### Dimensions RCFX [mm]

ØD nom/Ød1 nom	L	H	kg	pcs/box	box type
100 / 80	105	35	0,11	84	P12
125 / 80	117	35	0,16	63	P12
125 / 100	107	40	0,16	63	P12
160 / 100	125	40	0,23	60	P6
160 / 125	112	40	0,21	60	P6
200 / 100	145	40	0,31	52	P6
200 / 125	132	40	0,30	45	P6
200 / 160	115	40	0,29	75	P4
250 / 160	139	40	0,42	90	P2
250 / 200	120	40	0,38	99	P2
315 / 160	172	40	0,63	52	P2
315 / 200	152	40	0,59	60	P2
315 / 250	127	40	0,52	65	P2



Packaging method on page 38





## Segmented reducer without gasket RCS



Automatic linear  
welding



Top quality  
galvanised steel  
275 g/m<sup>2</sup>

### Description

Segmented male reducer without gasket - RCS, made from top quality galvanised steel (275 g/m<sup>2</sup>).

### Technical drawing

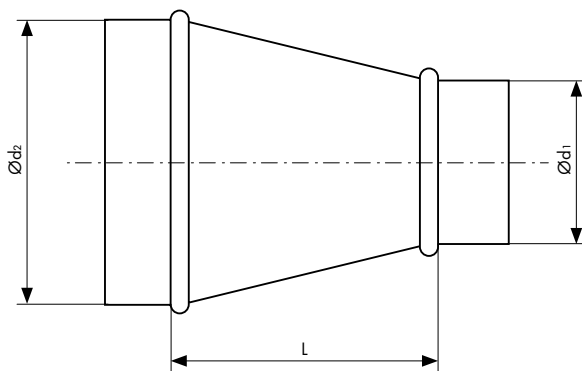

### Dimensions [mm]

Ød <sub>2</sub> nom/ Ød <sub>1</sub> nom	pcs/box	box type
250 / 100	24	P4
250 / 125	28	P4
315 / 100	45	P2
315 / 125	32	P2
400 / 200	60	P1
400 / 355	60	P1
450 / 315	30	P1
450 / 355	30	P1
450 / 400	35	P1
500 / 400	20	P1
500 / 450	40	P1
560 / 450	on request	
560 / 500	on request	
630 / 450	on request	
630 / 500	on request	
630 / 560	on request	
710 / 450	on request	
710 / 500	on request	
710 / 560	on request	
710 / 630	on request	
800 / 500	on request	
800 / 560	on request	
800 / 630	on request	
800 / 710	on request	
900 / 500	on request	
900 / 560	on request	
900 / 630	on request	
900 / 710	on request	
900 / 800	on request	
1000 / 560	on request	
1000 / 630	on request	
1000 / 710	on request	
1000 / 800	on request	
1000 / 900	on request	



Packaging method on page 38



## Segmented reducer with gasket RCXS



Rounded, reinforced  
"SAFE" edges



Double gasket,  
tightness class D



Automatic linear  
welding



Top quality  
galvanized steel  
275 g/m<sup>2</sup>

### Description

Segmented male reducer with gasket - "RCXS" **SAFE**, made from top quality galvanized steel (275 g/m<sup>2</sup>). Fully automated linear welding process. With every edge "SAFE" type - reinforced with curved rims, provide additional fitting rigidity and safe mounting. Double gasket EPDM clamped automatically ensures no risk of slipping during mounting.

### Technical drawing

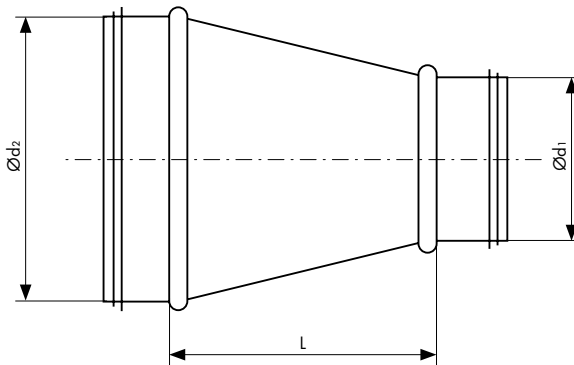

### Dimensions [mm]

Ød <sub>2</sub> nom/ Ød <sub>1</sub> nom	pcs/box	box type
250 / 100	24	P4
250 / 125	28	P4
315 / 100	45	P2
315 / 125	32	P2
400 / 200	60	P1
400 / 355	60	P1
450 / 315	30	P1
450 / 355	30	P1
450 / 400	35	P1
500 / 400	20	P1
500 / 450	40	P1
560 / 450	on request	
560 / 500	on request	
630 / 450	on request	
630 / 500	on request	
630 / 560	on request	
710 / 450	on request	
710 / 500	on request	
710 / 560	on request	
710 / 630	on request	
800 / 500	on request	
800 / 560	on request	
800 / 630	on request	
800 / 710	on request	
900 / 500	on request	
900 / 560	on request	
900 / 630	on request	
900 / 710	on request	
900 / 800	on request	
1000 / 560	on request	
1000 / 630	on request	
1000 / 710	on request	
1000 / 800	on request	
1000 / 900	on request	



Packaging method on page 38



## Pressed collar saddle, without gasket

### PS



Rounded, reinforced  
"SAFE" edges



Top quality  
galvanised steel  
275 g/m<sup>2</sup>

### Description

Collar saddle without gasket "PS" **SAFE**, made from top quality galvanised steel (275 g/m<sup>2</sup>). Fully automated stamping process from one metal sheet. With every edge "SAFE" type - reinforced with curved rims, provide additional fitting rigidity and safe mounting.

### Technical drawing

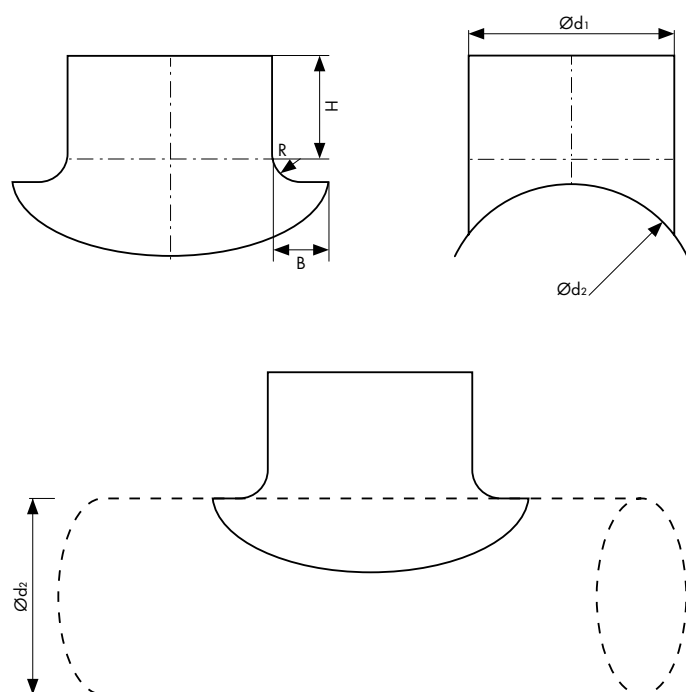

### Dimensions [mm]

Ød <sub>2</sub> nom/ Ød <sub>1</sub> nom	H	B	R	kg	pcs/box	box type
80 / 80	40	30	10	0,10	70	P12
100 / 80	40	30	10	0,10	60	P12
100 / 100	40	32	12	0,14	85	P6
125 / 80	40	30	10	0,10	60	P12
125 / 100	40	32	12	0,12	90	P6
125 / 125	40	32	12	0,21	70	P4
160 / 80	40	30	10	0,09	75	P12
160 / 100	40	32	12	0,12	105	P6
160 / 125	40	32	12	0,19	85	P4
160 / 160	40	36	16	0,34	70	P2
200 / 80	40	30	10	0,09	70	P12
200 / 100	40	32	12	0,12	100	P6
200 / 125	40	32	12	0,17	80	P4
200 / 160	40	36	16	0,29	54	P4
200 / 200	40	50	20	0,46	63	P2
250 / 100	40	32	12	0,12	100	P6
250 / 125	40	32	12	0,17	105	P4
250 / 160	40	36	16	0,29	68	P4
250 / 200	40	50	20	0,41	32	P4
250 / 250	40	50	20	0,63	38	P2
315 / 100	40	32	12	0,12	115	P6
315 / 125	40	32	12	0,17	100	P4
315 / 160	40	36	16	0,27	66	P4
315 / 200	40	50	20	0,41	32	P4
315 / 250	40	50	20	0,50	44	P2
315 / 315	40	55	25	0,85	60	P1
400 / 100	40	32	12	0,12	100	P6
400 / 160	40	36	16	0,25	76	P4
400 / 200	40	50	20	0,37	38	P4
400 / 250	40	50	20	0,49	44	P2
400 / 315	40	55	25	0,68	66	P1
450 / 200	40	50	20	0,37	38	P4
450 / 250	40	50	20	0,37	22	P4
450 / 315	35	7	-	-	60	P1
500 / 315	35	7	-	-	-	-



Packaging method on page 38



## Pressed collar saddle, with gasket **PSX**



Rounded, reinforced  
"SAFE" edges



Double gasket,  
tightness class D



Top quality  
galvanised steel  
275 g/m<sup>2</sup>

### Description

Collar saddle with gasket "PSX" **SAFE**, made from top quality galvanised steel (275 g/m<sup>2</sup>). Fully automated stamping process from one metal sheet. With every edge "SAFE" type - reinforced with curved rims, provide additional fitting rigidity and safe mounting. Double gasket EPDM clamped automatically ensures no risk of slipping during mounting.

### Technical drawing

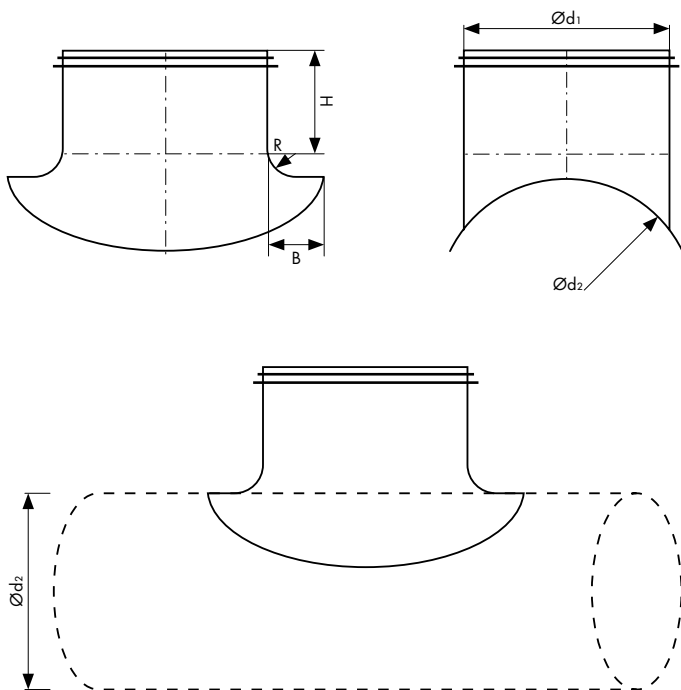

### Dimensions [mm]

Ød <sub>2</sub> nom/ Ød <sub>1</sub> nom	H	B	R	kg	pcs/box	box type
80 / 80	35	30	10	0,1	60	P12
100 / 80	35	30	10	0,1	60	P12
100 / 100	35	32	12	0,14	75	P6
125 / 80	35	30	10	0,1	60	P12
125 / 100	35	32	12	0,13	90	P6
125 / 125	35	32	12	0,21	65	P4
160 / 80	35	30	10	0,09	60	P12
160 / 100	35	32	12	0,12	100	P6
160 / 125	35	32	12	0,19	75	P4
160 / 160	35	36	16	0,34	48	P4
200 / 80	35	30	10	0,09	70	P12
200 / 100	35	32	12	0,12	100	P6
200 / 125	35	32	12	0,17	75	P4
200 / 160	35	36	16	0,29	54	P4
200 / 200	35	50	20	0,46	64	P2
250 / 100	35	32	12	0,12	100	P6
250 / 125	35	32	12	0,17	90	P4
250 / 160	35	36	16	0,29	62	P4
250 / 200	35	50	20	0,41	32	P4
250 / 250	35	50	20	0,63	38	P2
315 / 100	35	32	12	0,12	115	P6
315 / 125	35	32	12	0,17	90	P4
315 / 160	35	36	16	0,27	66	P4
315 / 200	35	50	20	0,41	32	P4
315 / 250	35	50	20	0,5	40	P2
315 / 315	35	55	25	0,85	48	P1
400 / 100	35	32	12	0,12	100	P6
400 / 160	35	36	16	0,25	66	P4
400 / 200	35	50	20	0,37	38	P4
400 / 250	35	50	20	0,49	44	P2
400 / 315	35	55	25	0,68	54	P1
450 / 200	35	50	20	0,37	38	P4
450 / 250	35	7	-	-	22	P4
450 / 315	35	7	-	-	60	P1
500 / 315	35	7	-	-	-	-



Packaging method on page 38



## T-piece without gasket TB



Automatic linear  
welding



Top quality  
galvanised steel  
275 g/m<sup>2</sup>

### Description

T-piece without gasket - "TB" **VENTO**, made from top quality galvanised steel (275 g/m<sup>2</sup>). Fully automated linear welding process.

### Technical drawing

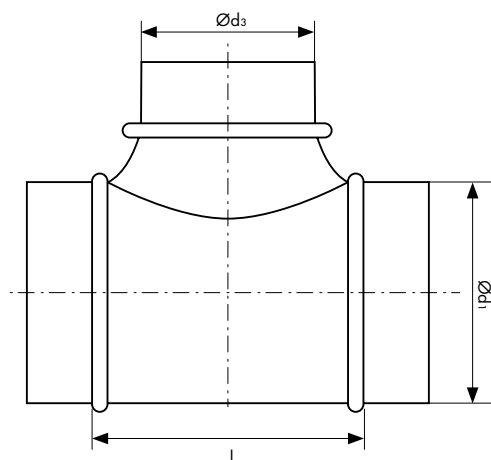

### Dimensions [mm]

Ød1 nom/ Ød3 nom	L	kg	pcs/box	box type
80 / 80	d <sub>s</sub> + 50	0,36	51	P6
100 / 80	d <sub>s</sub> + 50	0,23	110	P2
100 / 100	d <sub>s</sub> + 50	0,32	84	P2
125 / 80	d <sub>s</sub> + 50	0,34	72	P2
125 / 100	d <sub>s</sub> + 50	0,37	60	P2
125 / 125	d <sub>s</sub> + 50	0,75	52	P2
160 / 80	d <sub>s</sub> + 50	0,53	50	P2
160 / 100	d <sub>s</sub> + 50	0,46	30	P2
160 / 125	d <sub>s</sub> + 50	0,53	34	P2
160 / 160	d <sub>s</sub> + 50	0,63	28	P2
200 / 80	d <sub>s</sub> + 50	0,74	33	P2
200 / 100	d <sub>s</sub> + 50	0,88	27	P2
200 / 125	d <sub>s</sub> + 50	1,02	24	P2
200 / 160	d <sub>s</sub> + 50	1,09	34	P1
200 / 200	d <sub>s</sub> + 50	1,21	34	P1
250 / 100	d <sub>s</sub> + 50	1,30	30	P1
250 / 125	d <sub>s</sub> + 50	1,47	36	P1
250 / 160	d <sub>s</sub> + 50	1,58	24	P1
250 / 200	d <sub>s</sub> + 50	1,61	22	P1
250 / 250	d <sub>s</sub> + 50	2,40	19	P1
315 / 100	d <sub>s</sub> + 50	1,50	24	P1
315 / 125	d <sub>s</sub> + 50	1,85	16	P1
315 / 160	d <sub>s</sub> + 50	2,00	16	P1
315 / 200	d <sub>s</sub> + 50	2,03	14	P1
315 / 250	d <sub>s</sub> + 50	4,20	12	P1
315 / 315	d <sub>s</sub> + 50	3,66	9	P1
400 / 100	d <sub>s</sub> + 70	1,85		on request
400 / 125	d <sub>s</sub> + 70	2,23		on request
400 / 160	d <sub>s</sub> + 70	2,55		on request
400 / 200	d <sub>s</sub> + 70	2,80		on request
400 / 250	d <sub>s</sub> + 70	3,20		on request
400 / 315	d <sub>s</sub> + 70	4,18		on request
450 / 200	d <sub>s</sub> + 70	2,90		on request
450 / 250	d <sub>s</sub> + 70	3,60		on request
450 / 315	d <sub>s</sub> + 70	4,40		on request
500 / 100	d <sub>s</sub> + 70	2,70		on request
500 / 125	d <sub>s</sub> + 70	2,90		on request
500 / 160	d <sub>s</sub> + 70	3,70		on request
500 / 200	d <sub>s</sub> + 70	4,10		on request
500 / 250	d <sub>s</sub> + 70	4,60		on request
500 / 315	d <sub>s</sub> + 50	5,50		on request
560 / 250	d <sub>s</sub> + 70	5,20		on request



Packaging method on page 38

## Dimensions [mm]

Ød <sub>1</sub> nom/ Ød <sub>3</sub> nom	L	kg	pcs/box	box type
560 / 315	d <sub>3</sub> + 70	6,05		on request
560 / 355	d <sub>3</sub> + 70	6,50		on request
560 / 400	d <sub>3</sub> + 70	7,40		on request
560 / 450	d <sub>3</sub> + 70	8,60		on request
560 / 500	d <sub>3</sub> + 70	10,70		on request
560 / 560	d <sub>3</sub> + 70	12,00		on request
630 / 100	d <sub>3</sub> + 70	3,70		on request
630 / 125	d <sub>3</sub> + 70	4,00		on request
630 / 160	d <sub>3</sub> + 70	4,30		on request
630 / 200	d <sub>3</sub> + 70	5,10		on request
630 / 250	d <sub>3</sub> + 70	6,00		on request
630 / 315	d <sub>3</sub> + 70	7,00		on request
630 / 355	d <sub>3</sub> + 70	7,60		on request
630 / 400	d <sub>3</sub> + 70	8,50		on request
630 / 450	d <sub>3</sub> + 70	9,50		on request
630 / 500	d <sub>3</sub> + 50	11,00		on request
630 / 560	d <sub>3</sub> + 70	12,30		on request
630 / 600	d <sub>3</sub> + 70	14,00		on request
630 / 630	d <sub>3</sub> + 70	14,77		on request
710 / 315	d <sub>3</sub> + 100	7,29		on request
710 / 355	d <sub>3</sub> + 70	8,30		on request
710 / 400	d <sub>3</sub> + 70	9,50		on request
710 / 450	d <sub>3</sub> + 70	11,00		on request
710 / 500	d <sub>3</sub> + 70	11,60		on request
710 / 560	d <sub>3</sub> + 70	13,00		on request

Ød <sub>1</sub> nom/ Ød <sub>3</sub> nom	L	kg	pcs/box	box type
710 / 630	d <sub>3</sub> + 70	15,00		on request
710 / 710	d <sub>3</sub> + 70	17,50		on request
800 / 400	d <sub>3</sub> + 50	11,00		on request
800 / 450	d <sub>3</sub> + 70	12,10		on request
800 / 500	d <sub>3</sub> + 70	13,30		on request
800 / 560	d <sub>3</sub> + 70	14,80		on request
800 / 630	d <sub>3</sub> + 70	16,60		on request
800 / 710	d <sub>3</sub> + 70	19,60		on request
800 / 800	d <sub>3</sub> + 70	28,60		on request
900 / 450	d <sub>3</sub> + 70	17,50		on request
900 / 500	d <sub>3</sub> + 70	19,00		on request
900 / 560	d <sub>3</sub> + 70	21,00		on request
900 / 630	d <sub>3</sub> + 70	23,00		on request
900 / 710	d <sub>3</sub> + 70	27,00		on request
900 / 800	d <sub>3</sub> + 50	32,00		on request
900 / 900	d <sub>3</sub> + 70	35,50		on request
1000 / 400	d <sub>3</sub> + 70	20,00		on request
1000 / 450	d <sub>3</sub> + 70	22,00		on request
1000 / 500	d <sub>3</sub> + 70	24,00		on request
1000 / 560	d <sub>3</sub> + 70	26,00		on request
1000 / 630	d <sub>3</sub> + 70	29,00		on request
1000 / 710	d <sub>3</sub> + 70	32,00		on request
1000 / 800	d <sub>3</sub> + 70	37,00		on request
1000 / 900	d <sub>3</sub> + 70	44,00		on request
1000 / 1000	d <sub>3</sub> + 70	53,00		on request



Packaging method on page 38





## T-piece with gasket TX



Rounded, reinforced  
"SAFE" edges



Double gasket,  
tightness class D



Automatic linear  
welding



Top quality  
galvanized steel  
275 g/m<sup>2</sup>

### Description

T-piece with gasket - "TX" **SAFE**, made from top quality galvanized steel (275 g/m<sup>2</sup>). With every edge "SAFE" type - reinforced with curved rims, provide additional fitting rigidity and safe mounting. Double gasket EPDM clamped automatically ensures no risk of slipping during mounting.

### Technical drawing

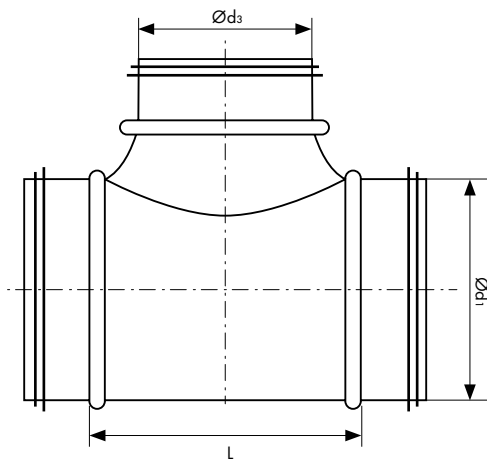

### Dimensions [mm]

$\varnothing d_1$ nom/ $\varnothing d_3$ nom	L	kg	pcs/box	box type
80 / 80	$d_3 + 70$	0,36	50	P6
100 / 80	$d_3 + 70$	0,23	54	P4
100 / 100	$d_3 + 70$	0,32	84	P2
125 / 80	$d_3 + 70$	0,34	60	P2
125 / 100	$d_3 + 70$	0,37	60	P2
125 / 125	$d_3 + 70$	0,75	52	P2
160 / 80	$d_3 + 70$	0,53	50	P2
160 / 100	$d_3 + 70$	0,46	78	P1
160 / 125	$d_3 + 70$	0,53	32	P2
160 / 160	$d_3 + 70$	0,63	60	P1
200 / 100	$d_3 + 70$	0,88	27	P2
200 / 125	$d_3 + 70$	1,02	50	P1
200 / 160	$d_3 + 70$	1,09	16	P2
200 / 200	$d_3 + 70$	1,21	32	P1
250 / 100	$d_3 + 70$	1,30	33	P1
250 / 125	$d_3 + 70$	1,47	36	P1
250 / 160	$d_3 + 70$	1,58	22	P1
250 / 200	$d_3 + 70$	1,61	20	P1
250 / 250	$d_3 + 70$	2,40	19	P1
315 / 100	$d_3 + 70$	1,50	24	P1
315 / 125	$d_3 + 70$	1,85	20	P1
315 / 160	$d_3 + 70$	2,00	16	P1
315 / 200	$d_3 + 70$	2,03	14	P1
315 / 250	$d_3 + 70$	4,20	12	P1
315 / 315	$d_3 + 70$	3,66	9	P1
355 / 100	$d_3 + 70$	1,37	10	P1
355 / 125	$d_3 + 70$	1,51	10	P1
355 / 150	$d_3 + 70$	1,7	10	P1
355 / 160	$d_3 + 70$	1,75	10	P1
355 / 200	$d_3 + 70$	2,2	10	P1
355 / 250	$d_3 + 70$	2,5	10	P1
355 / 315	$d_3 + 70$	3,15	5	P1
355 / 355	$d_3 + 70$	3,8	5	P1
400 / 100	$d_3 + 100$	1,85		on request
400 / 125	$d_3 + 100$	1,9		on request
400 / 160	$d_3 + 100$	2,55		on request
400 / 200	$d_3 + 100$	2,80		on request



Packaging method on page 38

## Dimensions [mm]

Ød <sub>1</sub> nom/ Ød <sub>3</sub> nom	L	kg	pcs/box	box type
400 / 250	d <sub>3</sub> + 100	3,20		on request
400 / 315	d <sub>3</sub> + 100	4,18		on request
400 / 355	d <sub>3</sub> + 100	4,50		on request
400 / 400	d <sub>3</sub> + 100	5,40		on request
450 / 125	d <sub>3</sub> + 100	-		on request
450 / 160	d <sub>3</sub> + 100	2,50		on request
450 / 200	d <sub>3</sub> + 100	2,90		on request
450 / 250	d <sub>3</sub> + 100	3,60		on request
450 / 315	d <sub>3</sub> + 100	4,40		on request
450 / 355	d <sub>3</sub> + 100	4,70		on request
450 / 400	d <sub>3</sub> + 100	5,60		on request
450 / 450	d <sub>3</sub> + 100	7,10		on request
500 / 100	d <sub>3</sub> + 100	2,70		on request
500 / 125	d <sub>3</sub> + 100	2,90		on request
500 / 160	d <sub>3</sub> + 100	3,70		on request
500 / 200	d <sub>3</sub> + 100	4,10		on request
500 / 250	d <sub>3</sub> + 100	4,60		on request
500 / 315	d <sub>3</sub> + 100	5,50		on request
500 / 355	d <sub>3</sub> + 100	6,10		on request
500 / 400	d <sub>3</sub> + 100	7,00		on request
500 / 450	d <sub>3</sub> + 100	8,10		on request
500 / 500	d <sub>3</sub> + 100	9,60		on request
560 / 250	d <sub>3</sub> + 100	5,20		on request
560 / 315	d <sub>3</sub> + 100	6,05		on request
560 / 355	d <sub>3</sub> + 100	6,50		on request
560 / 400	d <sub>3</sub> + 100	7,40		on request
560 / 450	d <sub>3</sub> + 100	8,60		on request
560 / 500	d <sub>3</sub> + 100	10,70		on request
560 / 560	d <sub>3</sub> + 100	12,00		on request
630 / 100	d <sub>3</sub> + 100	3,70		on request
630 / 125	d <sub>3</sub> + 100	4,00		on request
630 / 160	d <sub>3</sub> + 100	4,30		on request
630 / 200	d <sub>3</sub> + 100	5,10		on request
630 / 250	d <sub>3</sub> + 100	6,00		on request
630 / 315	d <sub>3</sub> + 100	7,00		on request
630 / 355	d <sub>3</sub> + 100	7,60		on request

Ød <sub>1</sub> nom/ Ød <sub>3</sub> nom	L	kg	pcs/box	box type
630 / 400	d <sub>3</sub> + 100	8,50		on request
630 / 450	d <sub>3</sub> + 100	9,50		on request
630 / 500	d <sub>3</sub> + 100	11,00		on request
630 / 560	d <sub>3</sub> + 100	12,30		on request
630 / 630	d <sub>3</sub> + 100	14,77		on request
710 / 355	d <sub>3</sub> + 100	8,30		on request
710 / 400	d <sub>3</sub> + 100	9,50		on request
710 / 450	d <sub>3</sub> + 100	11,00		on request
710 / 500	d <sub>3</sub> + 100	11,60		on request
710 / 560	d <sub>3</sub> + 100	13,00		on request
710 / 630	d <sub>3</sub> + 100	15,00		on request
710 / 710	d <sub>3</sub> + 100	17,50		on request
800 / 355	d <sub>3</sub> + 100	10,39		on request
800 / 400	d <sub>3</sub> + 100	11,00		on request
800 / 450	d <sub>3</sub> + 100	12,10		on request
800 / 500	d <sub>3</sub> + 100	13,30		on request
800 / 560	d <sub>3</sub> + 100	14,80		on request
800 / 630	d <sub>3</sub> + 100	16,60		on request
800 / 710	d <sub>3</sub> + 100	19,60		on request
800 / 800	d <sub>3</sub> + 100	28,60		on request
900 / 450	d <sub>3</sub> + 100	17,50		on request
900 / 500	d <sub>3</sub> + 100	19,00		on request
900 / 560	d <sub>3</sub> + 100	21,00		on request
900 / 630	d <sub>3</sub> + 100	23,00		on request
900 / 710	d <sub>3</sub> + 100	27,00		on request
900 / 800	d <sub>3</sub> + 100	32,00		on request
900 / 900	d <sub>3</sub> + 100	35,50		on request
1000 / 400	d <sub>3</sub> + 100	20,00		on request
1000 / 450	d <sub>3</sub> + 100	22,00		on request
1000 / 500	d <sub>3</sub> + 100	24,00		on request
1000 / 560	d <sub>3</sub> + 100	26,00		on request
1000 / 630	d <sub>3</sub> + 100	29,00		on request
1000 / 710	d <sub>3</sub> + 100	32,00		on request
1000 / 800	d <sub>3</sub> + 100	37,00		on request
1000 / 900	d <sub>3</sub> + 100	44,00		on request
1000 / 1000	d <sub>3</sub> + 100	53,00		on request



Packaging method on page 38



## Y-piece without gasket YB



Automatic linear  
welding



Top quality  
galvanised steel  
275 g/m<sup>2</sup>

### Description

Y-piece without gasket - YB **VENTO**, made from top quality galvanised steel (275 g/m<sup>2</sup>).

### Technical drawing

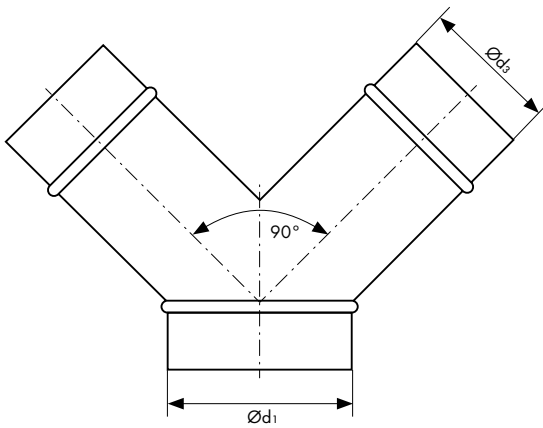

### Dimensions [mm]

Ød <sub>1</sub> nom/ Ød <sub>2</sub> nom	pcs/box	box type
100 / 100	80	P2
125 / 100	54	P2
125 / 125	42	P2
160 / 100	78	P1
160 / 125	25	P2
160 / 160	50	P1
200 / 125	40	P1
200 / 160	45	P1
200 / 200	25	P1
250 / 200	18	P1
250 / 250	19	P1
315 / 200	14	P1
315 / 250	10	P1
315 / 315	8	P1
400 / 200	-	-
400 / 400	4	P1



Packaging method on page 38



## Male coupling VB



Automatic linear  
welding

## Female coupling VFB



Top quality  
galvanised steel  
275 g/m<sup>2</sup>

### Description

Male coupling "VB" and female coupling "VFB" **VENTO**, made from top quality galvanised steel (275 g/m<sup>2</sup>). Fully automated linear welding process.

### Technical drawing VB

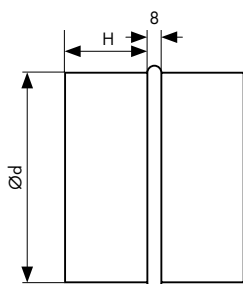

### Dimensions VB [mm]

Ød nom	H	kg	pcs/box	box type
80	40	0,12	80	P12
100	40	0,16	112	P6
125	40	0,2	81	P6
150	40	0,22	50	P6
160	40	0,24	70	P4
200	40	0,3	50	P4
250	40	0,39	72	P2
315	40	0,47	46	P2
355	40	0,58	55	P1
400	40	0,69	50	P1
450	45	0,81	20	P1
500	55	0,9	15	P1
560	55	1,01	21	P1
600	55	1,35	-	-
630	55	1,58	22	P1
710	55	1,78	10	-
800	80	3,09	-	-
900	100	3,48	-	-
1000	100	5,67	-	-

### Technical drawing VFB

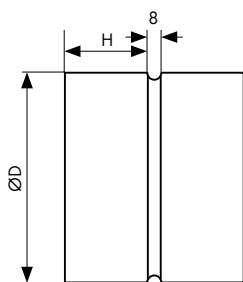

### Dimensions VFB [mm]

ØD nom	d	H	kg	pcs/box	pallet packaging
80	80,5	40	0,12	80	P12
100	100,5	40	0,16	112	P6
125	125,5	40	0,2	81	P6
150	150,6	40	0,22	50	P6
160	160,6	40	0,24	70	P4
200	200,7	40	0,3	50	P4
250	250,8	40	0,39	72	P2
315	315,9	40	0,47	46	P2
355	356,0	40	0,58	55	P1
400	401,0	40	0,69	50	P1
450	451,1	45	0,81	20	P1
500	501,1	55	0,9	15	P1
560	561,2	55	1,01	16	P1
600	601,2	75	1,6	12	P1
630	631,2	55	1,67	12	P1
710	711,6	100	2,75	10	P1
800	801,6	100	3,09	-	-
900	902	100	3,36	-	-
1000	1002	120	4,79	-	-



Packaging method on page 38



## Male coupling with gasket VX



Rounded, reinforced  
"SAFE" edges



Double gasket,  
tightness class D



Automatic linear  
welding



Top quality  
galvanised steel  
275 g/m<sup>2</sup>

### Description

Male coupling with gasket "VX" **SAFE**, made from top quality galvanised steel (275 g/m<sup>2</sup>). Automated linear welding process. With every edge "SAFE" type - reinforced with curved rims, provide additional fitting rigidity and safe mounting. Double gasket EPDM clamped automatically ensures no risk of slipping during mounting. Product with tightness class D - every single bend undergoes air tightness test in the factory.

### Technical drawing

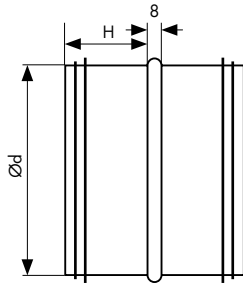

### Dimensions [mm]

Ød nom	H	kg	pcs/box	box type
80	40	0,12	80	P12
100	40	0,15	112	P6
125	40	0,19	81	P6
150	40	0,22	45	P6
160	40	0,24	70	P4
200	40	0,3	50	P4
250	40	0,37	63	P2
315	40	0,47	36	P2
355	40	0,5	55	P1
400	40	0,67	50	P1
450	55	0,95	20	P1
500	55	1,06	18	P1
560	55	1,19	16	P1
600	55	1,29	16	P1
630	70	2,01	14	P1
710	70	2,26	10	P1
800	70	3,9	7	P1
900	70	4,6	-	-
1000	100	6,2	-	-



Packaging method on page 38

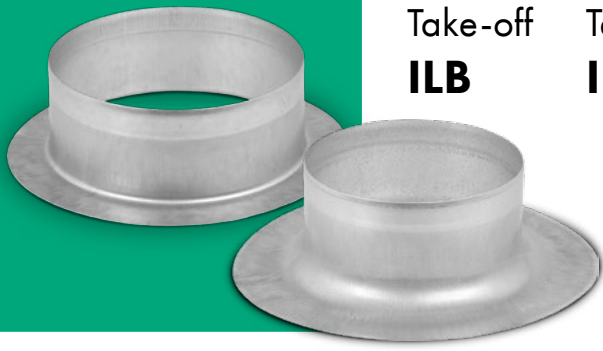

Take-off  
**ILB**

Take-off  
**ILRB**



Top quality  
galvanised steel  
275 g/m<sup>2</sup>

## Description

Take-off without gasket - "ILB", and pressed take-off "ILRB", are made from top quality galvanised steel (275 g/m<sup>2</sup>). Fully automated stamping process from one metal sheet.

## Technical drawing ILB

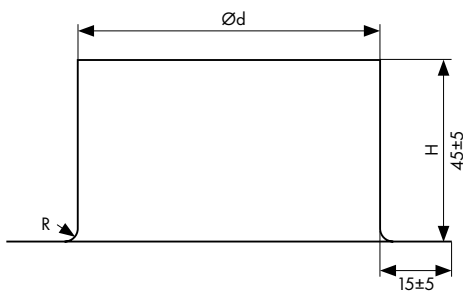

## Dimensions ILB [mm]

Ød nom	H	R	kg	pcs/box	box type
80	45	4	0,05	100	P12
100	45	4	0,08	70	P12
125	45	4	0,09	95	P6
150	45	4	0,14	70	P6
160	45	4	0,14	100	P4
200	45	4	0,18	70	P4
250	45	4	0,23	60	P4
315	45	4	0,24	45	P4
355	45	4	0,36	32	P4
400	45	4	0,4	45	P2
450	50	4	0,54	35	P2
500	65	4	0,6	48	P1

## Technical drawing ILRB

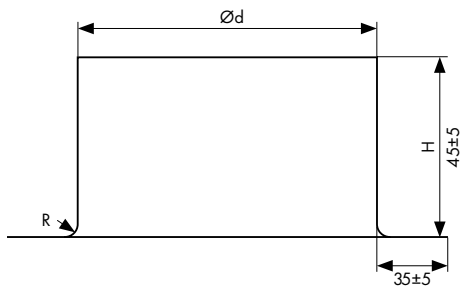

## Dimensions ILRB [mm]

Ød nom	H	R	kg	pcs/box	box type
80	45	12	0,1	70	P12
100	45	15	0,14	40	P12
125	45	20	0,18	50	P6
150	45	20	0,22	45	P6
160	45	25	0,27	50	P4
200	45	25	0,31	50	P4
250	45	25	0,37	70	P2
315	45	25	0,47	44	P2



Packaging method on page 38





## Take-off with gasket ILX



Rounded, reinforced  
"SAFE" edges



Double gasket,  
tightness class D



Top quality  
galvanised steel  
275 g/m<sup>2</sup>

### Description

Take-off with gasket "ILX" **SAFE**, made from top quality galvanised steel (275 g/m<sup>2</sup>). Fully automated stamping process from one metal sheet. With every edge "SAFE" type - reinforced with curved rims, provide additional fitting rigidity and safe mounting. Double gasket EPDM clamped automatically ensures no risk of slipping during mounting.

### Technical drawing

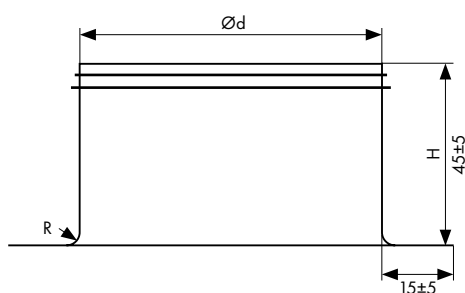

### Dimensions [mm]

Ød nom	H	R	kg	pcs/box	box type
80	40	4	0,05	100	P12
100	40	4	0,09	70	P12
125	40	4	0,11	95	P6
150	40	4	0,14	85	P6
160	40	4	0,14	100	P4
200	40	4	0,18	70	P4
250	40	4	0,23	60	P4
315	40	4	0,27	40	P4
355	40	4	0,34	32	P4
400	40	4	0,4	45	P2
450	50	4	0,6	30	P2
500	65	4	0,66	25	P2
560	65	4	0,74	25	P2
630	70	4	1,01	30	P1



Packaging method on page 38



## Dual end cap M/F DDF

## End cap for duct D



Top quality galvanized  
steel 275 g/m<sup>2</sup>

### Description

End cap for duct "spiro" - "D" (duct, fitting) and dual end cap male/female (duct) - "DDF" **VENTO**, are made from top quality galvanized steel (275 g/m<sup>2</sup>). Fully automated stamping process from one metal sheet.

### Technical drawing DDF



### Dimensions DDF [mm]

Ød nom	Ød	ØD	h	H	pcs/box	box type
80	78,8	81,5	30	60	60	P24
100	98,8	101,5	30	60	100	P24
125	123,8	126,5	30	60	27	P24
150	148,8	151,5	30	60	40	P12
160	158,8	161,5	30	60	32	P12
200	198,8	201,5	30	60	22	P12
250	248,8	251,5	30	60	32	P6
315	313,8	316,5	30	60	25	P6
355	353,8	356,5	30	60	23	P6
400	398,8	401,5	30	60	24	P6

### Technical drawing D



### Dimensions D [mm]

ØD nom	H	R	kg	pcs/box	box type
80	20	5	0,04	175	P24
100	20	5	0,08	125	P24
125	20	5	0,09	80	P24
150	20	5	0,14	60	P24
160	20	5	0,14	110	P12
200	20	5	0,2	70	P12
250	20	5	0,27	50	P12
315	20	5	0,51	40	P12
355	20	5	0,65	30	P12
400	20	5	0,67	50	P4
450	50	-	1,14	40	P1
500	65	-	1,46	33	P1



Packaging method on page 38

## End cap with gasket **DX**



Double gasket,  
tightness class D



Top quality  
galvanised steel  
275 g/m<sup>2</sup>

### Description

End cap "DX" **VENTO**, made from top quality galvanised steel (275 g/m<sup>2</sup>). Fully automated stamping process from one metal sheet. Double gasket EPDM clamped automatically ensures no risk of slipping during mounting.

### Technical drawing

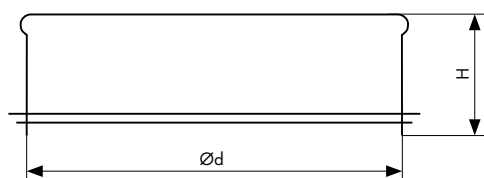

### Dimensions [mm]

Ød nom	H	kg	pcs/box	box type
80	35	0,1	60	P24
100	35	0,1	90	P12
125	35	0,1	110	P6
150	35	0,2	80	P6
160	35	0,2	36	P12
200	35	0,3	45	P6
250	55	0,6	25	P6
315	55	0,9	22	P6
355	55	1,2	42	P2
400	75	1,2	35	P2



Packaging method on page 38

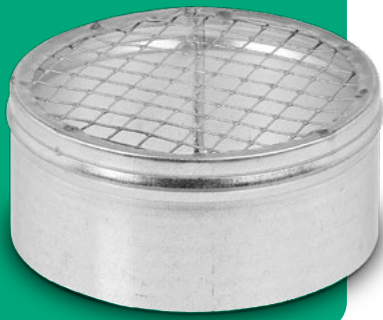

## Take-off with mesh ILGB



Automatic linear  
welding



Top quality  
galvanised steel  
275 g/m<sup>2</sup>

### Description

Take-off with mesh - "ILGB" **VENTO**, made from top quality galvanised steel (275 g/m<sup>2</sup>). Fully automated linear welding process.

### Technical drawing

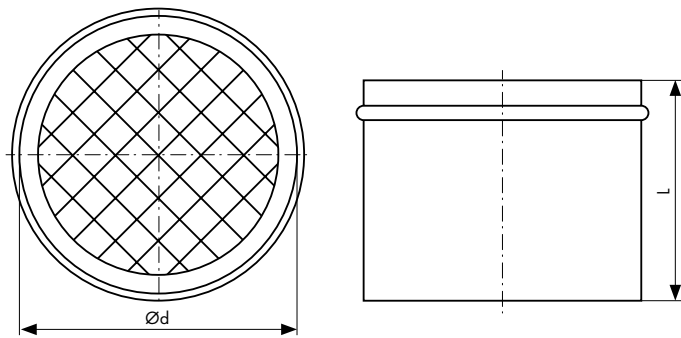

### Dimensions [mm]

Ød nom	L	pcs/box	box type
80	55	65	P24
100	55	37	P24
125	55	63	P12
150	55	40	P12
160	55	36	P12
200	55	50	P6
250	55	36	P6
315	55	20	P6
355	55	20	P6
400	55	20	P4
450	65	30	P2
500	65	25	P2
560	65	25	P2
630	65	-	-
710	65	-	-
800	115	-	-
900	115	-	-
1000	115	-	-



Packaging method on page 38



## Single blade damper DSCB



Rounded, reinforced  
"SAFE" edges



Automatic linear  
welding



Top quality  
galvanised steel  
275 g/m<sup>2</sup>

### Description

Single blade regulating damper - DSCB **VENTO**, made from top quality galvanised steel (275 g/m<sup>2</sup>). Fully automated linear welding process. Regulating mechanism for wool insulation.

### Technical drawing

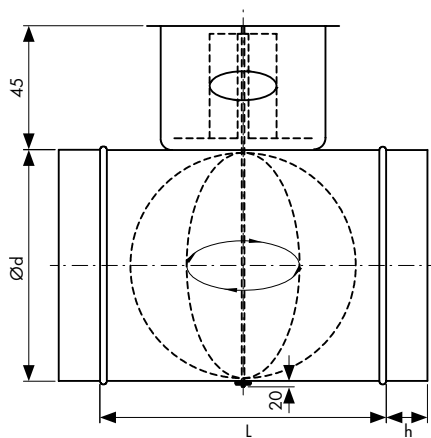

### Dimensions [mm]

Ød nom	L	h	kg	pcs/box	box type
80	90	40	0,34		on request
100	90	40	0,39	50	P6
125	90	40	0,43	35	P6
150	90	40	0,60	30	P4
160	90	40	0,66	35	P4
200	90	40	0,80	50	P2
250	90	50	1,30	48	P1
315	90	50	1,77	32	P1
355	90	50	2,05	20	P1
400	90	50	2,85	15	P1
450	90	75	2,7	10	P1
500	90	75	3,4	4	P2
560	90	75	4,07	5	P1
630	90	75	5,00	4	P1
710	90	75	5,59	-	-
800	90	100	6,6	-	-
900	90	100	9,2	-	-
1000	90	100	10,39	-	-



Packaging method on page 38



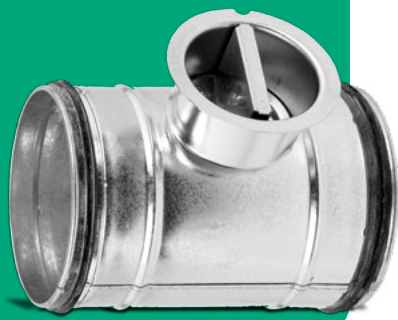

## Single blade damper with gasket DSCX



Rounded, reinforced  
"SAFE" edges



Double gasket,  
tightness class D



Automatic linear  
welding



Top quality  
galvanised steel  
275 g/m<sup>2</sup>

### Description

Single blade regulating damper with gasket - DSCX **VENTO**, made from top quality galvanised steel (275 g/m<sup>2</sup>). Fully automated linear welding process. With every edge "SAFE" type - reinforced with curved rims, provide additional fitting rigidity and safe mounting. Double gasket EPDM clamped automatically ensures no risk of slipping during mounting. Product with tightness class D - every single bend undergoes air tightness test in the factory.

### Technical drawing

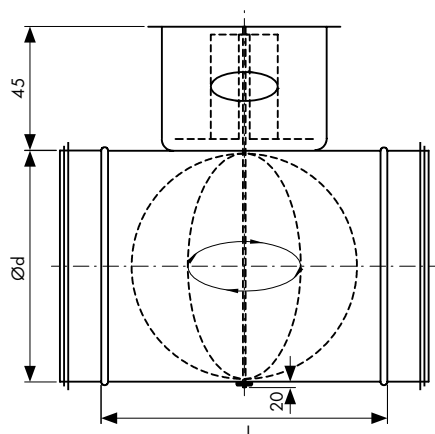

### Dimensions [mm]

Ød nom	L	kg	pcs/box	box type
80	90	0,34		on request
100	90	0,39	40	P6
125	90	0,43	27	P6
150	90	0,60	30	P4
160	90	0,66	27	P4
200	90	0,80	36	P2
250	90	1,30	36	P1
315	90	1,77	28	P1
355	90	2,05	20	P1
400	90	2,85	15	P1
450	90	2,85	10	P1
500	90	3,51	4	P2
560	90	4,26	5	P1
630	90	5,2	4	P1
710	90	5,83	-	-
800	90	6,86	-	-
900	90	9,5	-	-
1000	90	10,84	-	-



Packaging method on page 38



## Shut-off single blade damper with plate for actuator **DSLXMP**



Rounded, reinforced  
"SAFE" edges



Double gasket,  
tightness class D



Automatic linear  
welding



Top quality  
galvanised steel  
275 g/m<sup>2</sup>

### Description

Single blade regulating damper with plate for actuator - "DSLXMP" **SAFE**, made from top quality galvanised steel (275 g/m<sup>2</sup>). Fully automated linear welding process. With every edge "SAFE" type - reinforced with curved rims, provide additional fitting rigidity and safe mounting. Perfect for installations, which require air-tightness, due to the gasket mounted on the regulatory compartment. Product with tightness class D.

### Technical drawing

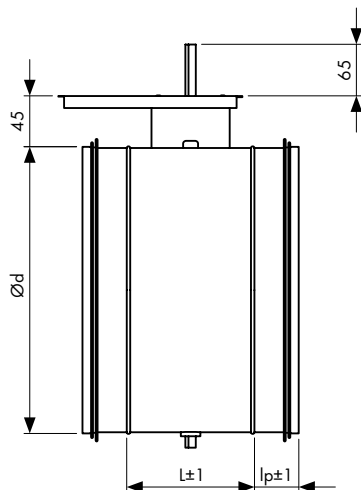
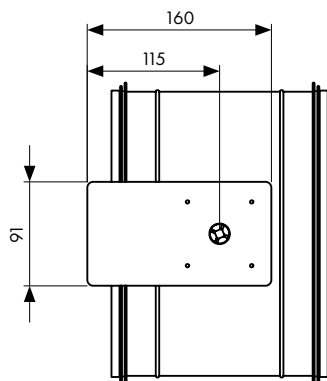

### Dimensions [mm]

Ød nom	Tolerance d		L	lp	pcs/box	box type
	min	max				
100	98,8	99,3	105	35		on request
125	123,8	124,3	105	35		on request
160	158,7	159,3	105	35		on request
200	198,6	199,3	105	35		on request
250	248,5	249,3	115	35	40	P1
315	313,4	314,3	115	35	24	P1
355	353,3	354,3	115	35	24	P1
400	398,3	399,3	115	35		on request
450	448,2	449,3	95	70		on request
500	498,2	499,3	95	70		on request
560	558,1	559,3	95	70		on request
630	628,1	629,3	95	70		on request



Packaging method on page 38

# Packaging

P1

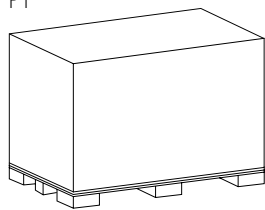

## Dimensions

Length [mm]	Depth [mm]	Height [mm]	Weight [kg]	Volume [m <sup>3</sup> ]	Boxes/pallet
1200	800	800	6,9	0,77	1

P2

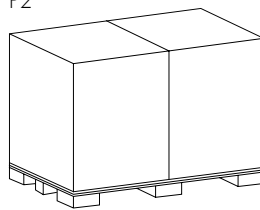

## Dimensions

Length [mm]	Depth [mm]	Height [mm]	Weight [kg]	Volume [m <sup>3</sup> ]	Boxes/pallet
600	800	800	3,1	0,38	2

P4

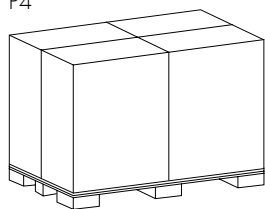

## Dimensions

Length [mm]	Depth [mm]	Height [mm]	Weight [kg]	Volume [m <sup>3</sup> ]	Boxes/pallet
600	400	800	1,4	0,19	4

P6

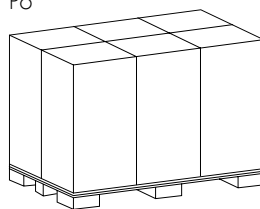

## Dimensions

Length [mm]	Depth [mm]	Height [mm]	Weight [kg]	Volume [m <sup>3</sup> ]	Boxes/pallet
400	400	800	1,1	0,13	6

P12

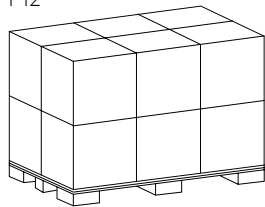

## Dimensions

Length [mm]	Depth [mm]	Height [mm]	Weight [kg]	Volume [m <sup>3</sup> ]	Boxes/pallet
400	400	400	0,8	0,064	12

P24

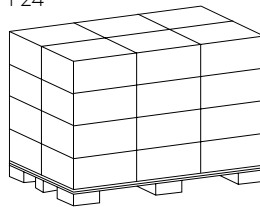

## Dimensions

Length [mm]	Depth [mm]	Height [mm]	Weight [kg]	Volume [m <sup>3</sup> ]	Boxes/pallet
400	400	200	0,55	0,032	24

## Round roof intake and exhaust **ORR**



### Description

Round roof (air intake/exhauster) "ORR", made from galvanised steel and protected with a mesh against installation contamination. The bottom part, which is connected to the base, is a "female" made. Flange or male connection can be made on request.

### Technical drawing

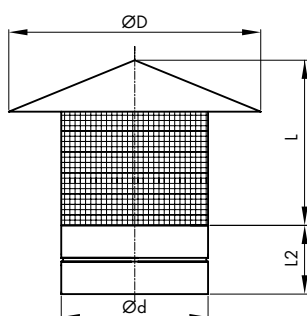

### Dimensions [mm]

Model	Ød nom	ØD	L2	L
ORR 100	100	200	90	120
ORR 125	125	250	90	140
ORR 160	160	320	90	180
ORR 200	200	400	90	220
ORR 250	250	500	130	260
ORR 315	315	630	130	310

## Cylindrical air exhauster **FRR**



### Description

Cylindrical air exhauster "FRR" is made from galvanised steel. The bottom part, which is connected to the base, is a "female" made. Flange or male connection can be made on request.

### Technical drawing

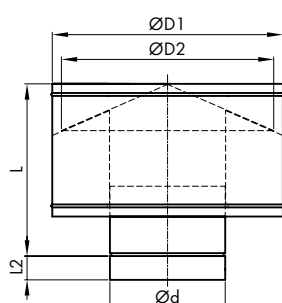

### Dimensions [mm]

Model	Ød nom	ØD1	ØD2	L2	L
FRR 100	100	200	160	60	165
FRR 125	125	250	200	60	206
FRR 160	160	320	256	60	264
FRR 200	200	400	320	80	330
FRR 250	250	500	400	80	413
FRR 315	315	630	504	100	520



## Round roof base **BRR**

### Description

Round roof base "BRR" enables the connection between ventilation system and air intake/exhauster "ORR", air exhauster "FRR", or a fan, at the plane of roof. Mounting on a roof requires (roof plinth/roof curb).

### Technical drawing

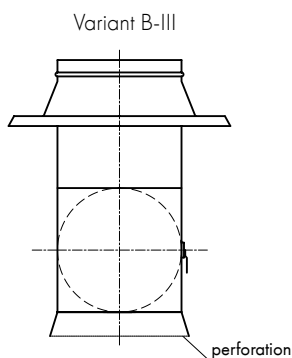
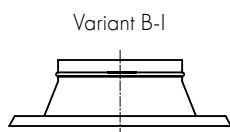
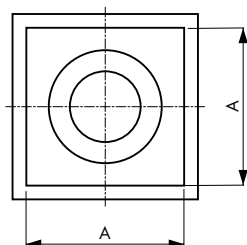
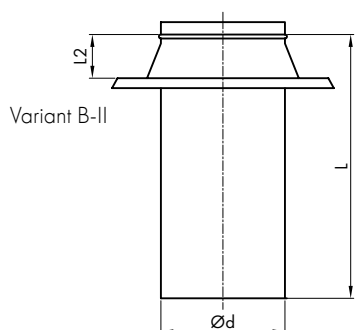

### Dimensions [mm]

Model	$\varnothing d$ nom	A	L2	L
<b>BRR 100</b>	100	360	40	1000
<b>BRR 125</b>	125	360	40	1000
<b>BRR 160</b>	160	360	40	1000
<b>BRR 200</b>	200	410	40	1000
<b>BRR 250</b>	250	470	40	1000
<b>BRR 315</b>	315	555	40	1000

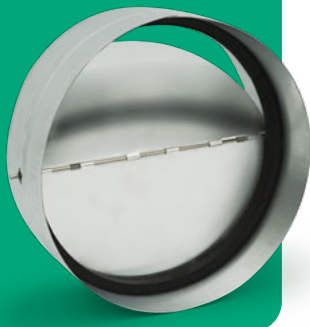

# Backdraft damper RSKV



Automatic operation



Noise-reducing gaskets



Durable construction

## Description

"RSKV" damper is a circular backdraft damper enabling the airflow only in one direction. Aluminium lamellae, while closing, touch foam gasket, reducing the noise level in duct ventilation installation. Due to the spring, which keeps lamellae closed, it is possible to use the damper also in vertical installations. Damper's band is made of galvanised steel.

## Technical drawing

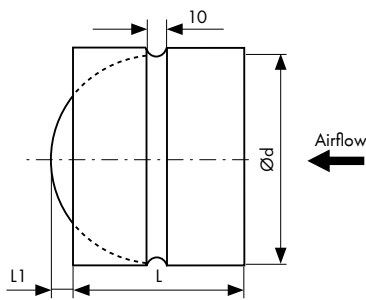

## Dimensions [mm]

Model	Ød	L1	L
RSKV 100	99	6	88
RSKV 125	124	19	88
RSKV 150	149	31	88
RSKV 160	159	36	88
RSKV 200	199	56	88
RSKV 250	249	61	128
RSKV 315	314	94	128
RSKV 400	399	64	198
RSKV 500	499	107	248

## Characteristics

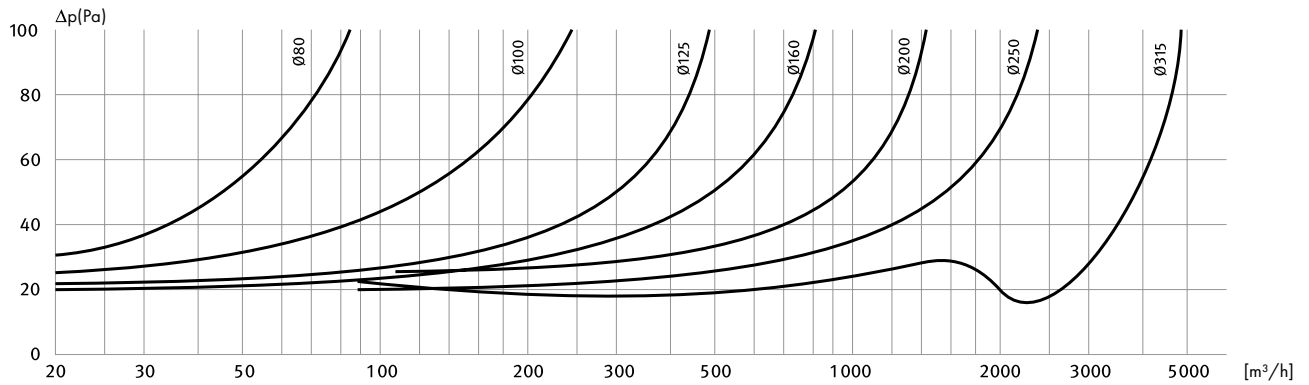



# Damper with flow meter IRIS



Precise regulation



Air measurement capability

## Description

Damper "IRIS" is applied, when infinitely regulating air pressure in air ducts. Special leverage design enables smooth change of the hole diameter. Due to lenticular closure, throttling does not affect turbulence and noise inside the duct. IRIS dampers can be applied in air supply or exhaust ducts. It is equipped with two endings, which enable connection with a measuring airflow rate device. IRIS lenticular damper has the ability to fully open, facilitating air duct cleaning. There is no possibility for the damper to be fully closed (remaining hole diameter constitutes 25% of the nominal diameter).

## Technical drawing

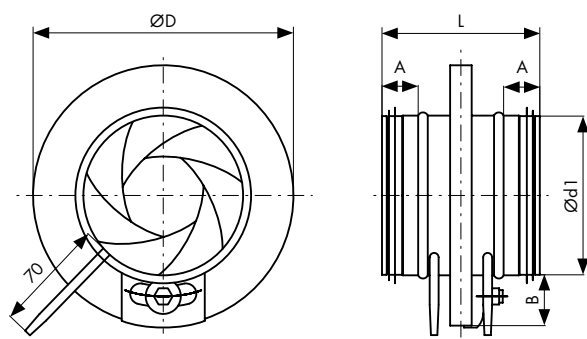

## Dimensions [mm]

Model	Ød1	ØD	L	A	B	Weight [kg]
80	80	125	110	30	22	0,5
100	100	165	110	30	32	0,5
125	125	188	110	30	32	0,7
150	150	230	110	30	40	1,3
160	160	230	110	30	35	0,9
200	200	285	110	30	42	1,4
250	250	335	135	40	42	2,1
315	315	410	135	40	47	3,5

## Characteristics

### IRIS 80

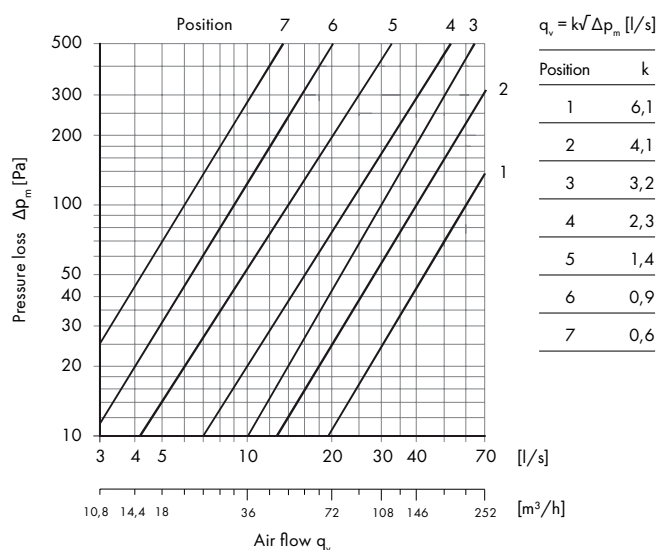

### IRIS 100

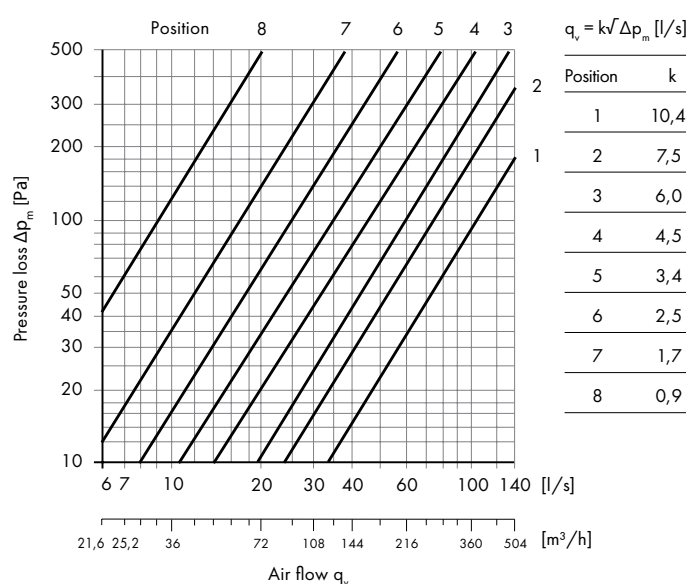

**IRIS 125**

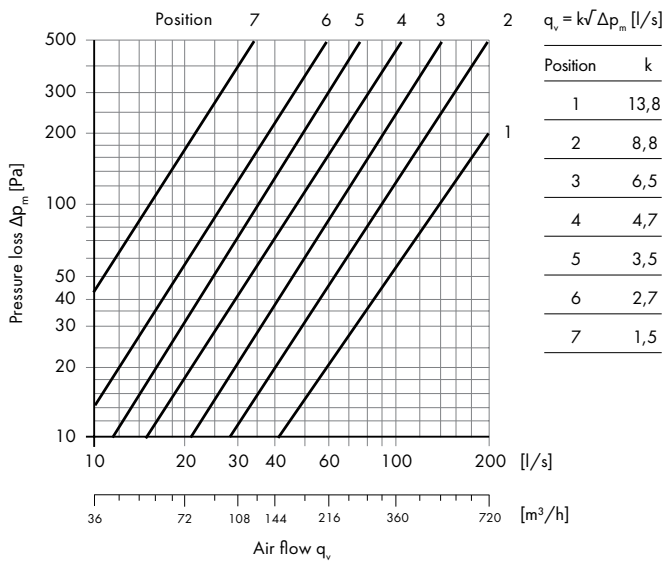

**IRIS 150**

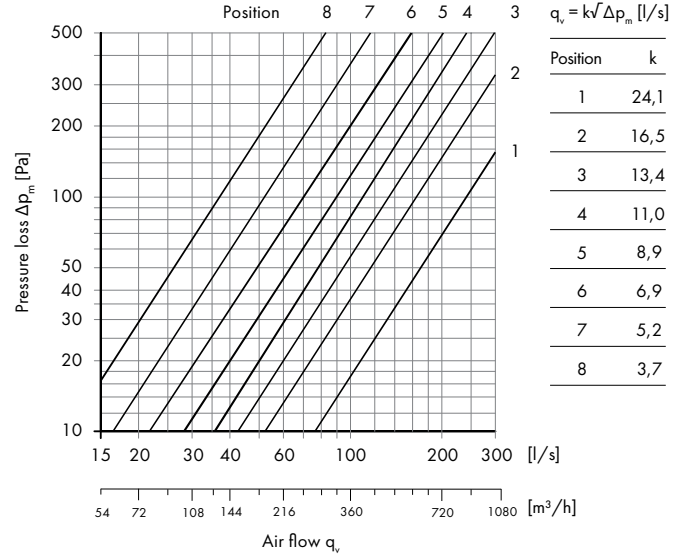

**IRIS 160**

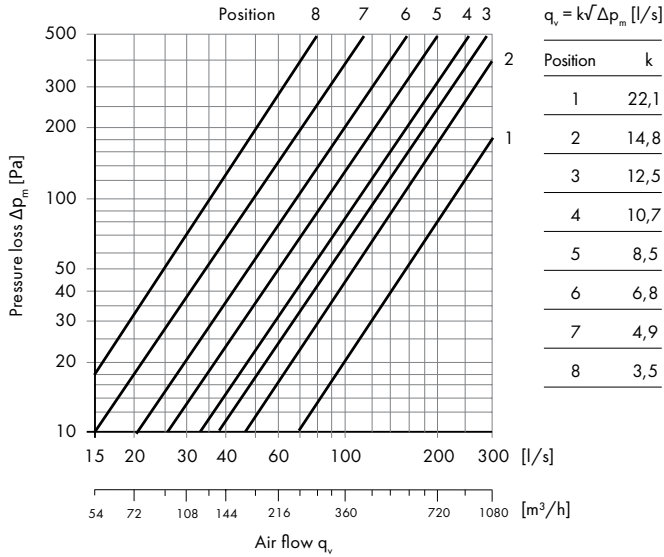

**IRIS 200**

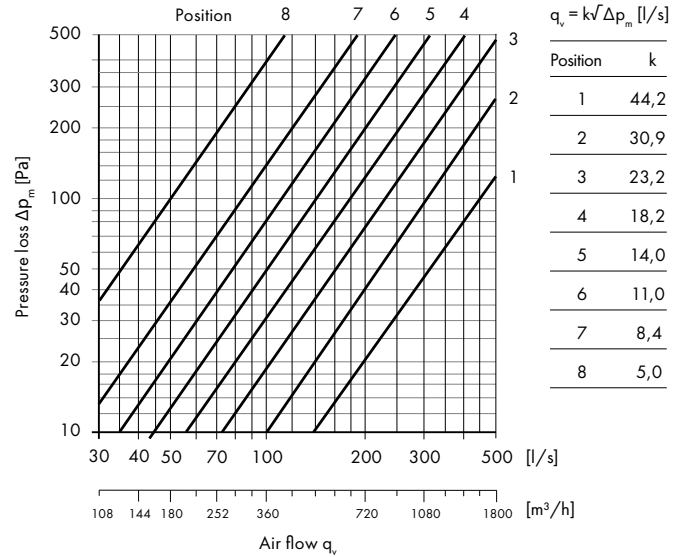

**IRIS 250**

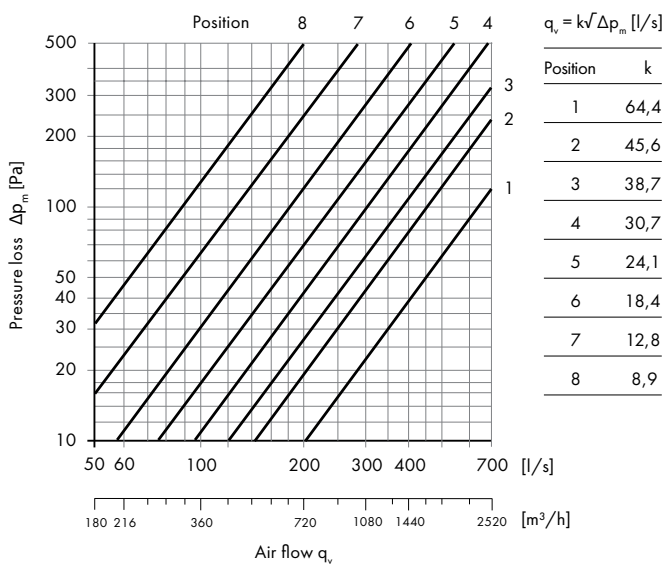

**IRIS 315**

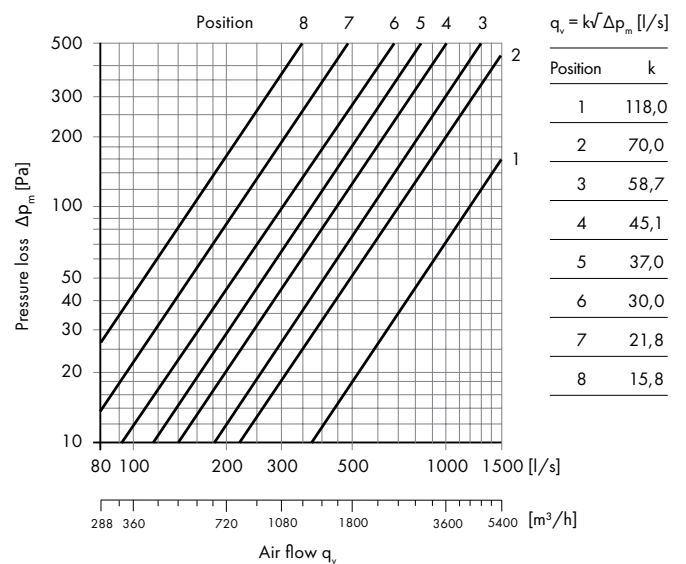



## Air valves EV, SV



Top quality  
galvanised steel  
275 g/m<sup>2</sup>



Powder-coated  
in white color  
RAL 9016



Mounting frame  
included



National Technical  
Assessment

### Description EV

Exhaust air valve "EV" is designed for assembly in ceiling, wall or directly on duct through specific mounting frame. Provides smooth air exhaust regulation by means of a rotating central disc. The selected gap is determined by locking nut. Special design guarantees low noise level and easy assembly. Powder coated in colour RAL 9016.

### Description SV

Supply air valve "SV" is designed for assembly in ceiling, wall, or directly on duct through specific mounting frame. Provides smooth air supply regulation by means of a rotating central disc. The selected gap is determined by locking nut. Special design guarantees low noise level and easy assembly. Powder coated in colour RAL 9016.

### Technical drawing EV

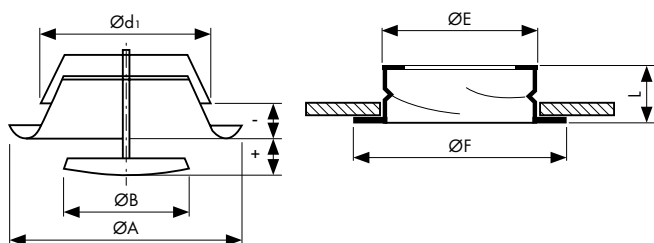

### Technical drawing SV

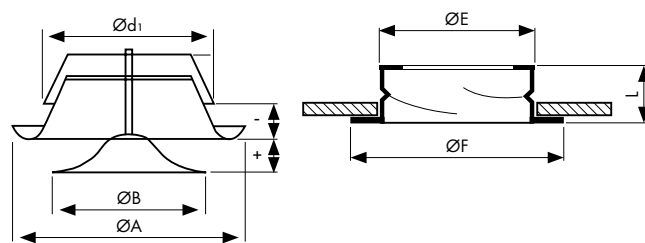

### Dimensions EV [mm]

Model	ØA	ØB	Ød <sub>1</sub>	ØE	ØF	L
EV 80	115	62	77,5	79	118	50
EV 100	138	75	97,5	98	125	50
EV 125	164	100	122,5	123	150	50
EV 150	202	120	147,5	148	176	50
EV 160	211	130	157,5	159	185	50
EV 200	248	158	197,5	198	225	50
EV 250	305	215	248,0	248	290	50

### Dimensions SV [mm]

Model	ØA	ØB	Ød <sub>1</sub>	ØE	ØF	L
SV 80	115	76	77,5	79	118	50
SV 100	138	92	97,5	98	125	50
SV 125	164	111	122,5	123	150	50
SV 150	202	135	147,5	148	176	50
SV 160	211	147	157,5	159	185	50
SV 200	248	194	197,5	198	225	50
SV 250	305	250	248,0	248	290	50

# Characteristics EV

**EV 80**  
regulation s (mm)

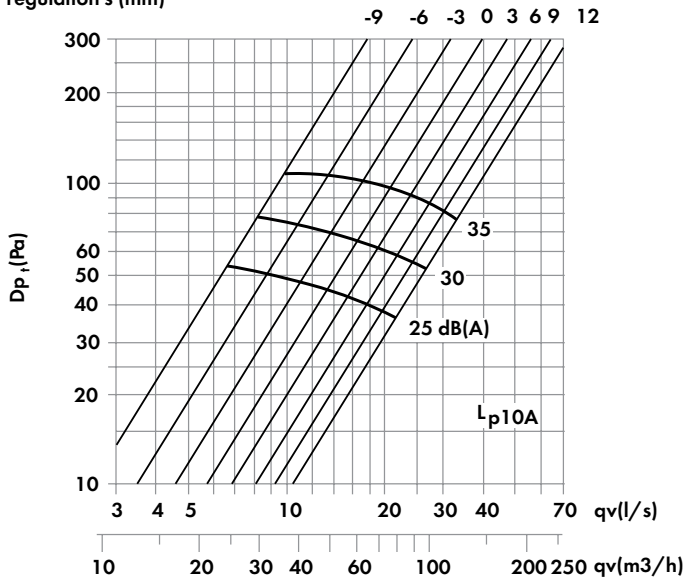

**EV 100**  
regulation s (mm)

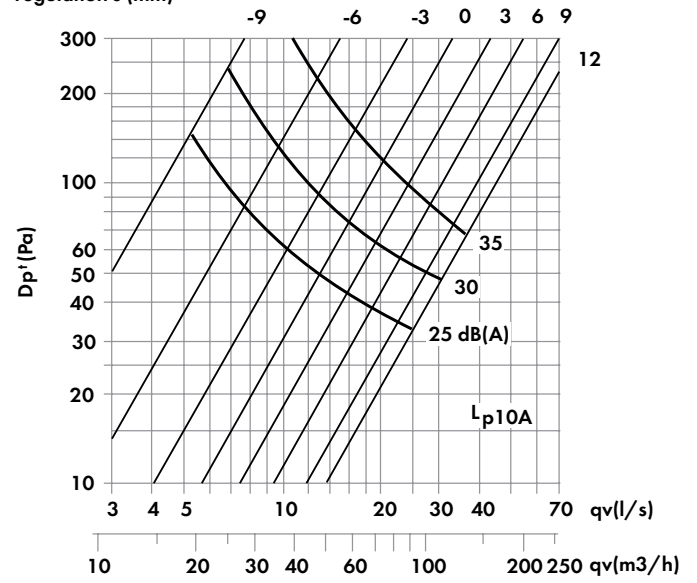

**EV 125**  
regulation s (mm)

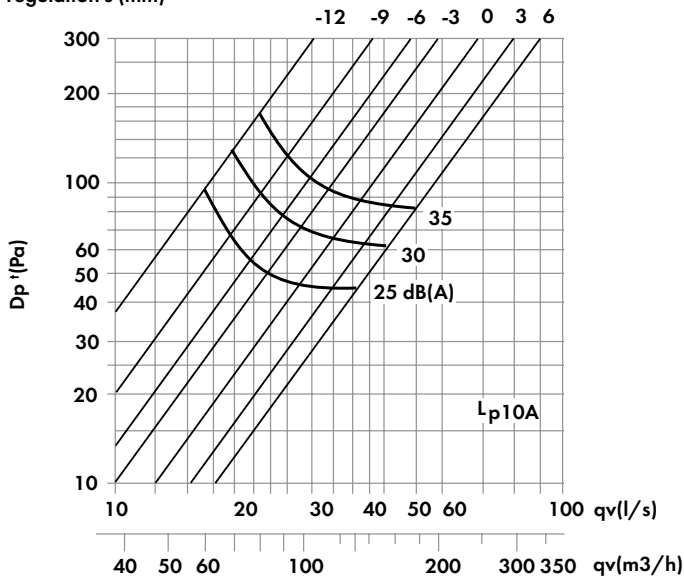

**EV 150**  
regulation s (mm)

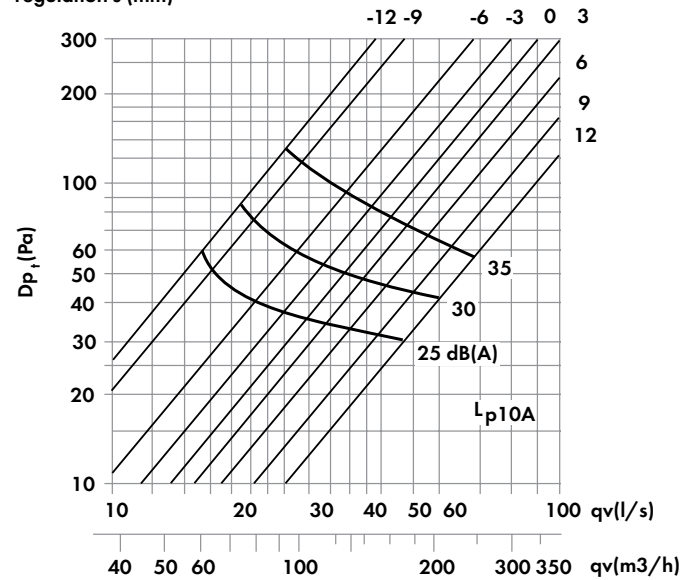

**Parameters**

The flow rate  $q$  [l/s or m<sup>3</sup>/h], the total pressure loss  $P_i$  [Pa], and the sound pressure level  $L_p$  [dB(A)] can be read from the chart.

## Characteristics EV

EV 160  
regulation s (mm)

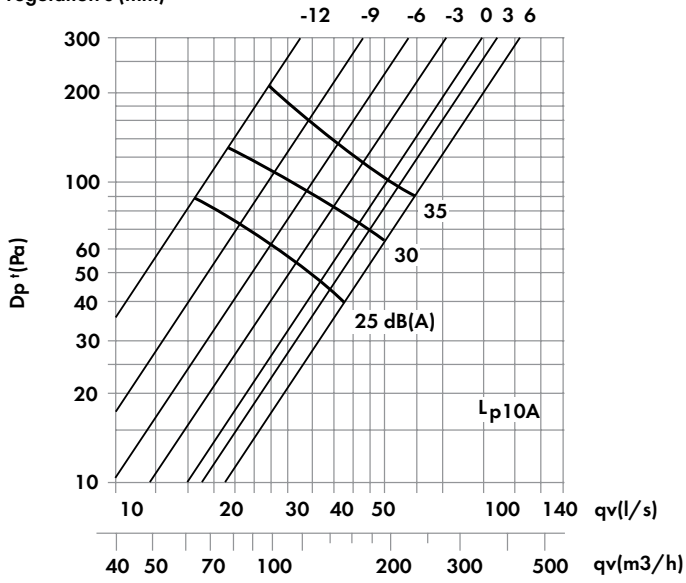

EV 200  
regulation s (mm)

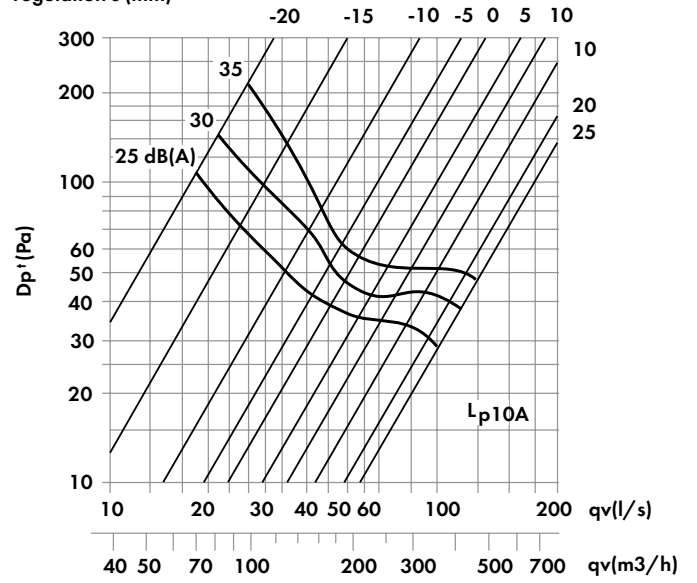

EV 250  
regulation s (mm)

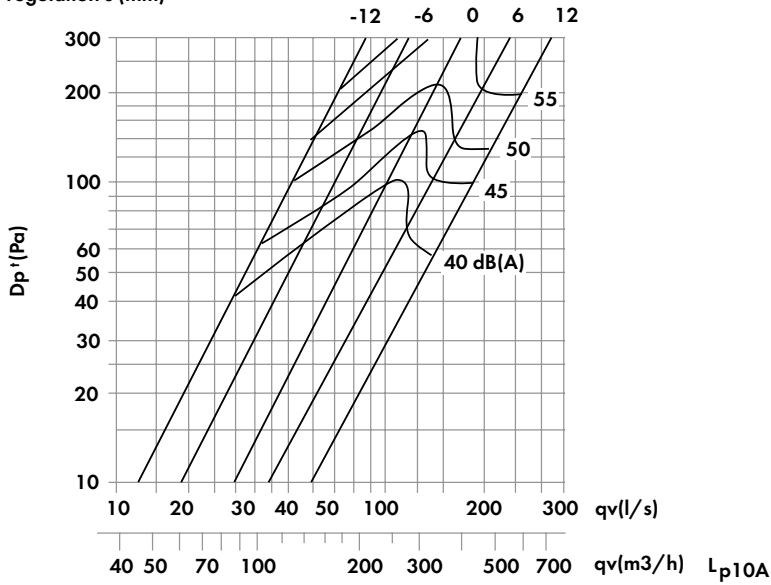

### Parameters

The flow rate  $q$  [l/s or m<sup>3</sup>/h], the total pressure loss  $P_t$  [Pa], and the sound pressure level  $L_A$  [dB(A)] can be read from the chart.

## Characteristics SV

**SV 80**  
regulation (mm)

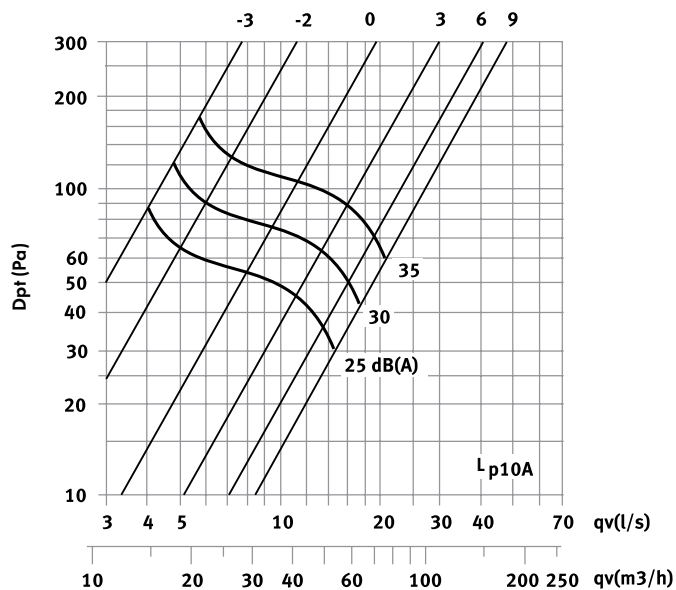

**SV 100**  
regulation (mm)

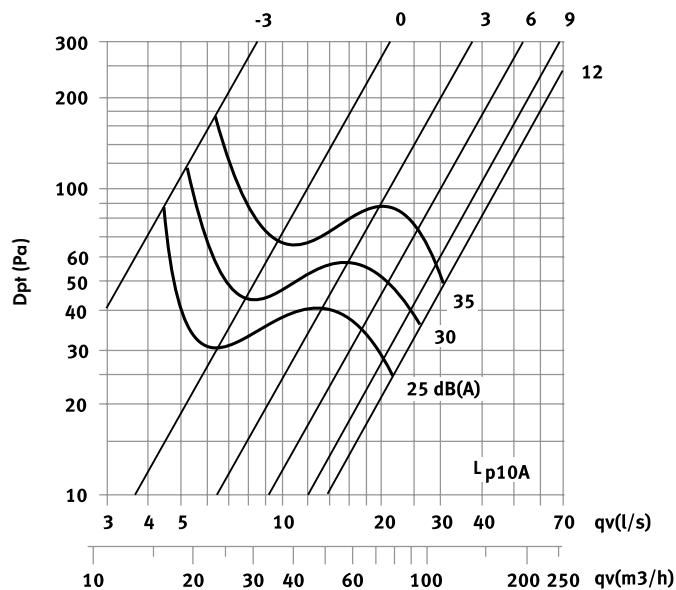

**SV 125**  
regulation (mm)

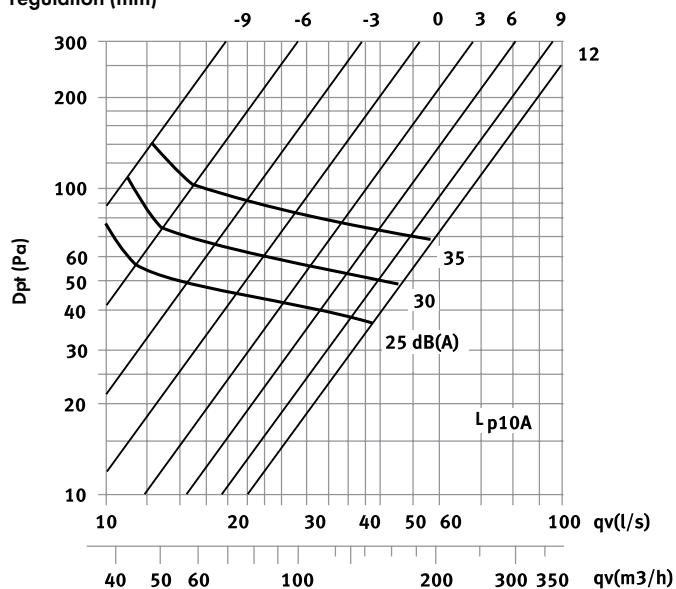

**SV 150**  
regulation (mm)

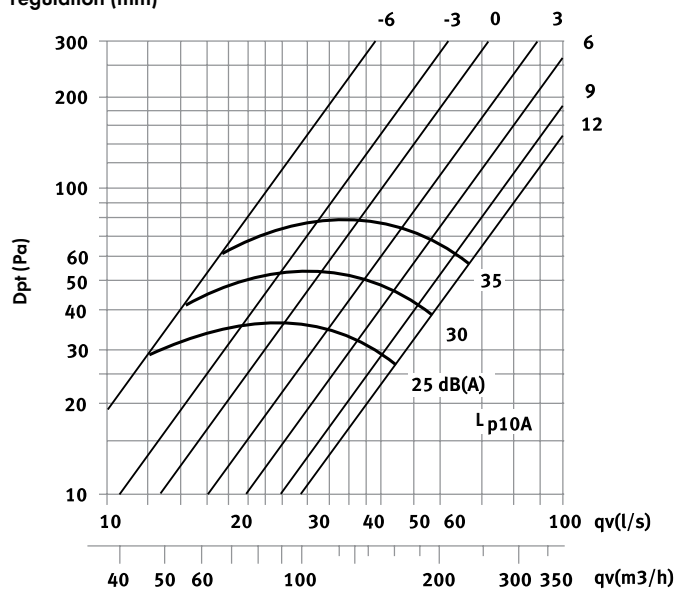

### Parameters

The flow rate  $q$  [l/s or m³/h], the total pressure loss  $P_t$  [Pa], and the sound pressure level  $L_{pA}$  [dB(A)] can be read from the chart.

## Characteristics SV

**SV 160**  
regulation (mm)

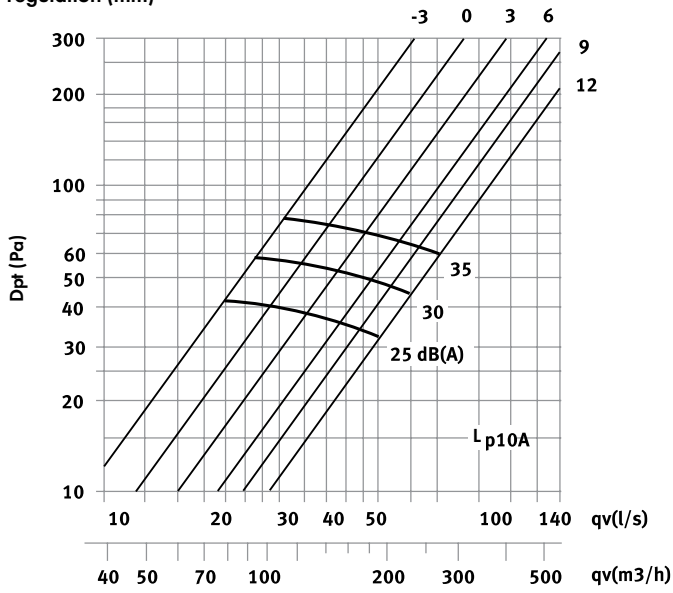

**SV 200**  
regulation (mm)

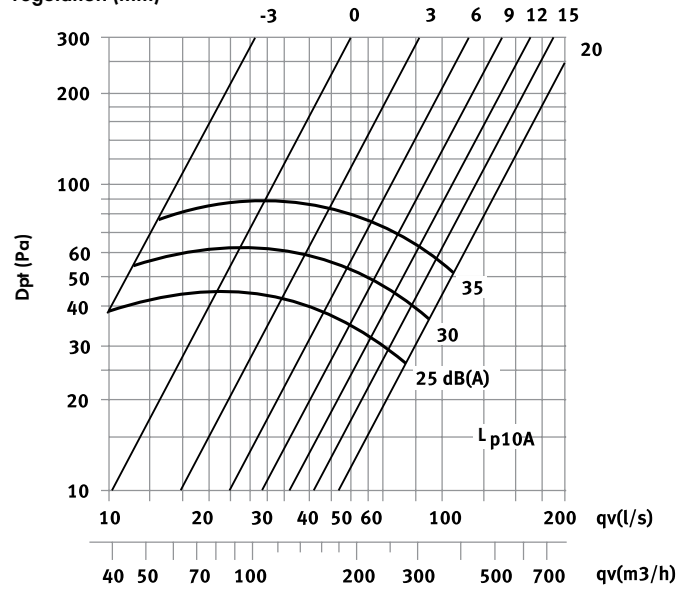

**SV 250**  
regulation (mm)

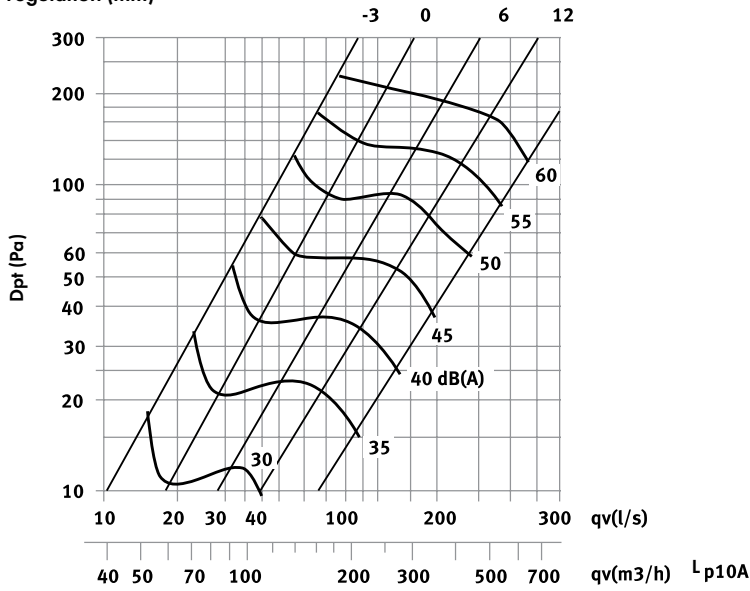

### Parameters

The flow rate  $q$  [ $l/s$  or  $m^3/h$ ], the total pressure loss  $P_t$  [Pa], and the sound pressure level  $L_A$  [dB(A)] can be read from the chart.



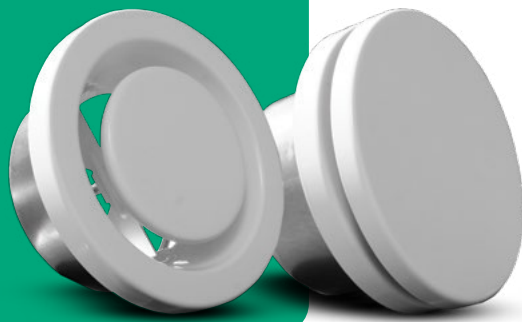

## Air valves SV-SC, EV-SC



Top quality galvanised steel  
275 g/m<sup>2</sup>



Powder-coated in white color  
RAL 9016



Mounting frame included



National Technical Assessment

### Description SV-SC

Supply air valve is designed for ceiling mounting. In set with mounting frame. Made of galvanised steel, powder coated, finished in colour RAL 9016. Worth mentioning is **special design additionally damped with soundproof material**, ensuring low noise level. Smooth supply air regulation by means of a rotating central disc. The valve is equipped with a locking nut allowing set a minimum gap. Product is characterised by high quality and great care of detail. Assembly directly on a duct or on a plenum box.

### Description EV-SC

Exhaust air valve is designed for ceiling mounting. In set with a mounting frame. Made of galvanised steel, powder coated, finished in colour RAL 9016. Smooth supply air regulation by means of a rotating central disc. The valve is equipped with a locking nut allowing set a minimum gap. Product is characterised by high quality and great care of detail. Assembly directly on a duct or on a plenum box.

### Technical drawing SV-SC (air supply)

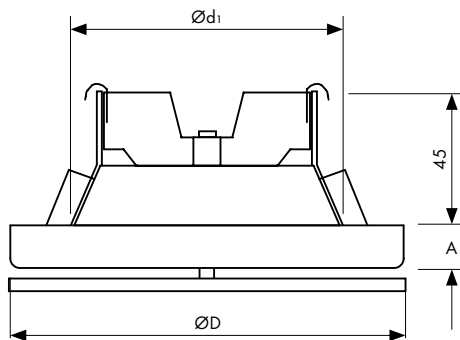

### Technical drawing EV-SC (air exhaust)

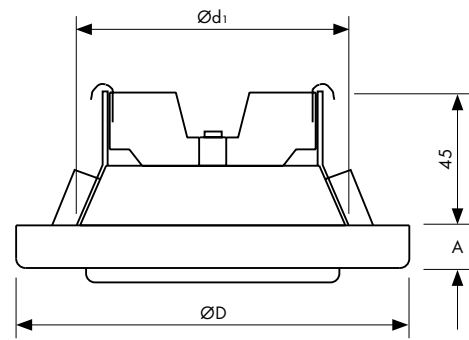

### Dimensions SV-SC [mm]

Model	ØD	Ød <sub>1</sub>	A
SV-SC 100	135	100	15
SV-SC 125	160	125	15
SV-SC 160	191	160	15
SV-SC 200	230	199	15

### Dimensions EV-SC [mm]

Model	ØD	Ød <sub>1</sub>	A
EV-SC 100	135	100	15
EV-SC 125	160	125	15
EV-SC 160	191	160	15
EV-SC 200	230	199	15

### The relationship between static pressure and air volume flow for air diffusers with different slot widths.

#### SV-SC 100

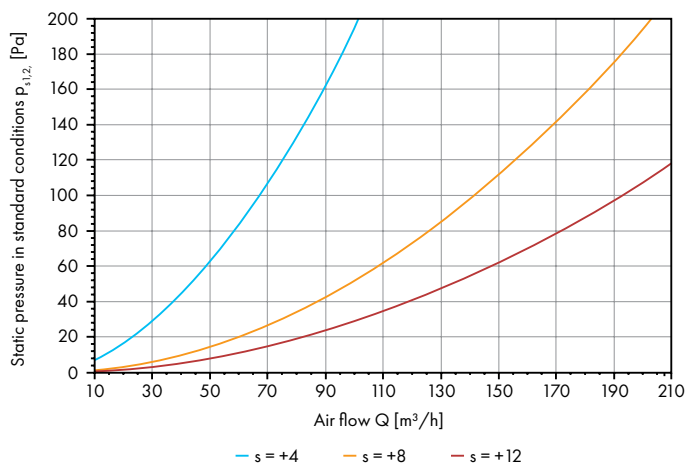

#### SV-SC 125

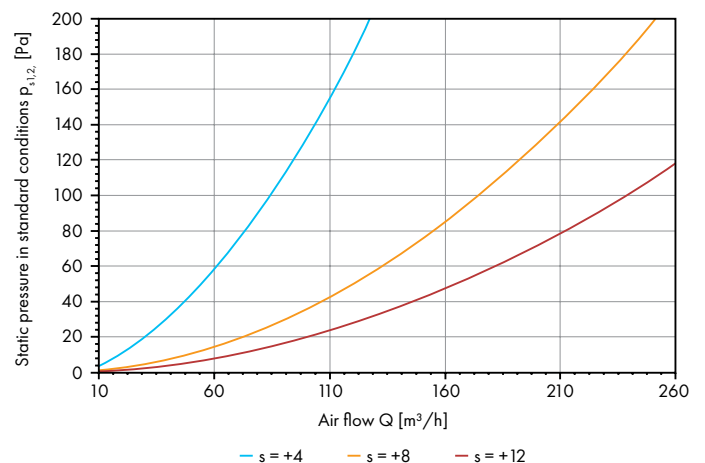

The relationship between static pressure and air volume flow for air diffusers with different slot widths.

SV-SC 160

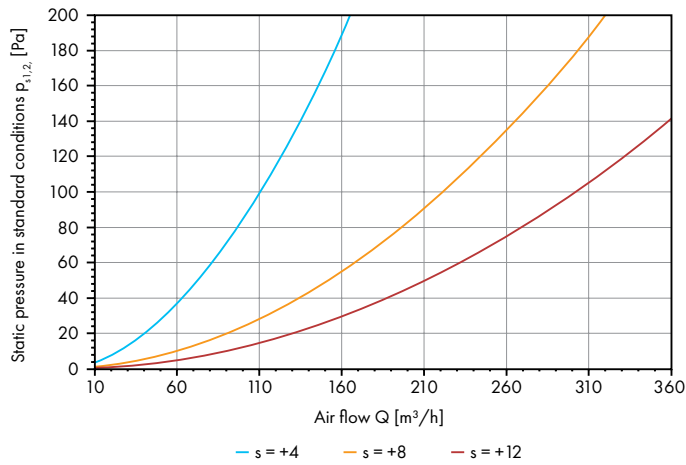

SV-SC 200

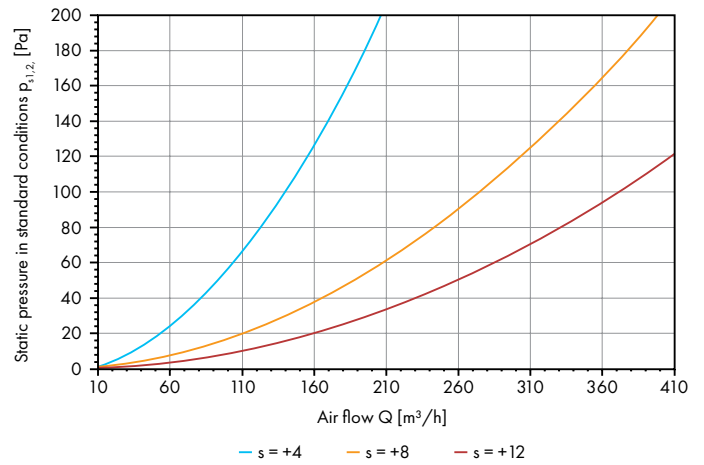

EV-SC 100

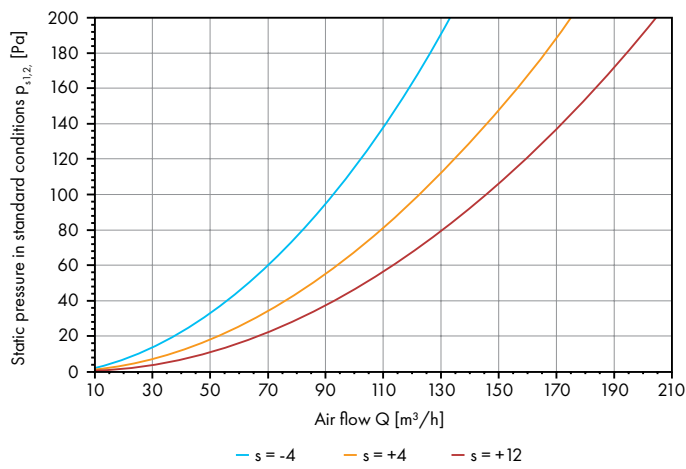

EV-SC 125

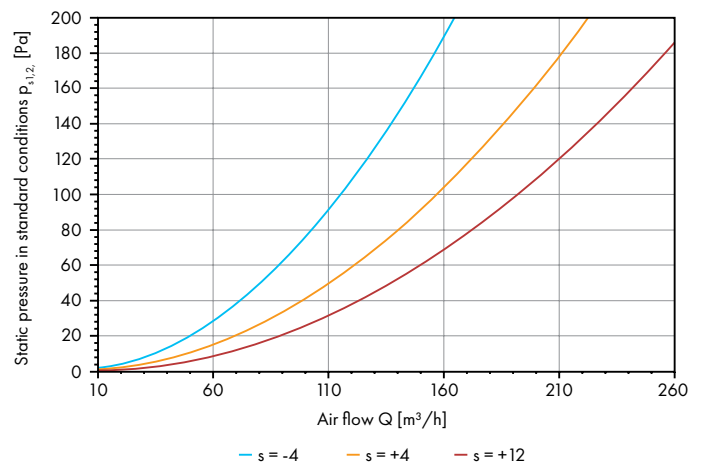

EV-SC 160

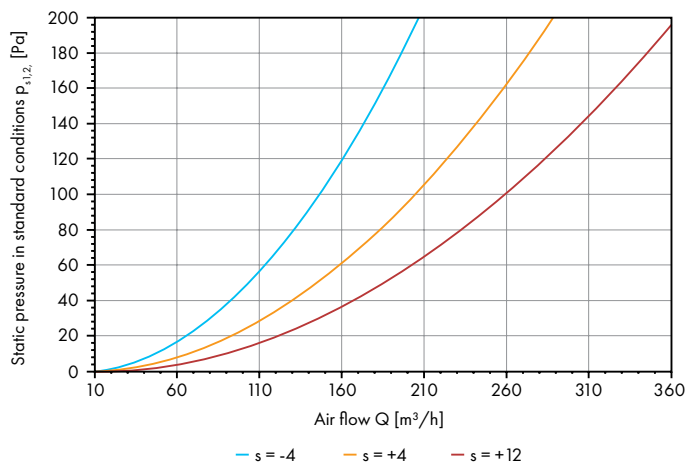

EV-SC 200

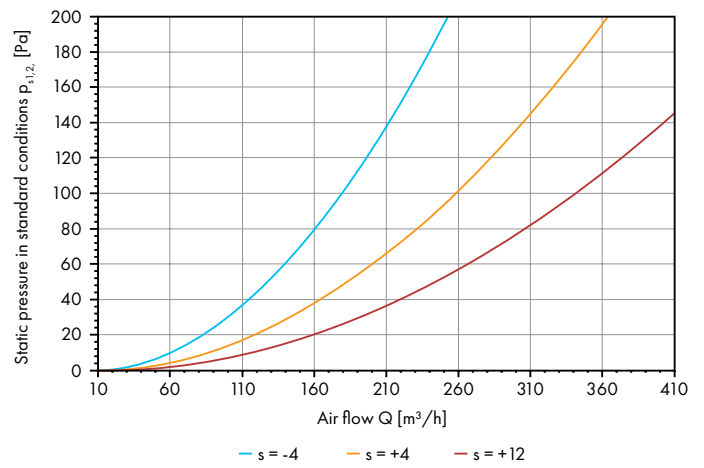



## Air valve VSE



Highest quality  
chrome-nickel steel



Versatile supply/exhaust  
installation

### Description

Air valves "VSE" are designed for supply and exhaust air ventilation systems. Smooth regulation enables accurate airflow adjustment. Its design provides optimal working in both ventilation types. Brushed surface. Valves "VSE" are characterised by high aesthetic and durability and effortless assembly. Made of chrome-nickel steel. In set with a mounting frame.

### Technical drawing

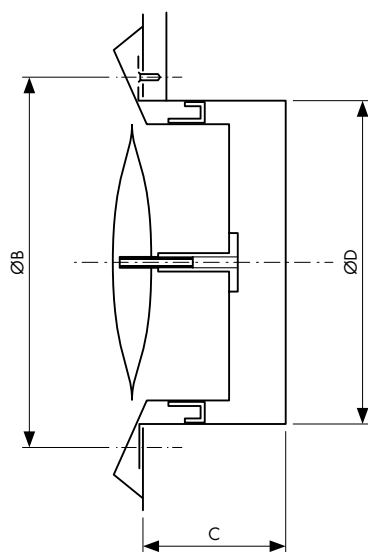

### Dimensions [mm]

Model	ØD	ØB	C
VSE 100	97	118	52
VSE 125	120	141	52
VSE 150	145	162	62
VSE 160	155	172	62
VSE 200	195	228	74



## Square diffusers RA40



Lightweight,  
aluminium



Removable  
center



Powder-coated  
in white color  
RAL 9016



National Technical  
Assessment

### Description

Diffusers "RA40" are designed for supplying cold or warm air. Made of anodised aluminium, powder coated, finished in colour RAL 9016. Removable middle part facilitates its maintenance. Simple and aesthetic design. Four-sided air flow. Blade angle 30°.

### Technical drawing

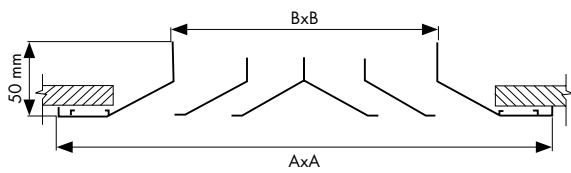

### Dimensions [mm]

Model	B	A	Numbers of blades
RA40 295x295	147	295	2
RA40 370x370	222	370	3
RA40 445x445	297	445	4
RA40 520x520	372	520	5
RA40 595x595	447	595	6

### Pressure drop on the RA40 diffuser depending on the air flow rate

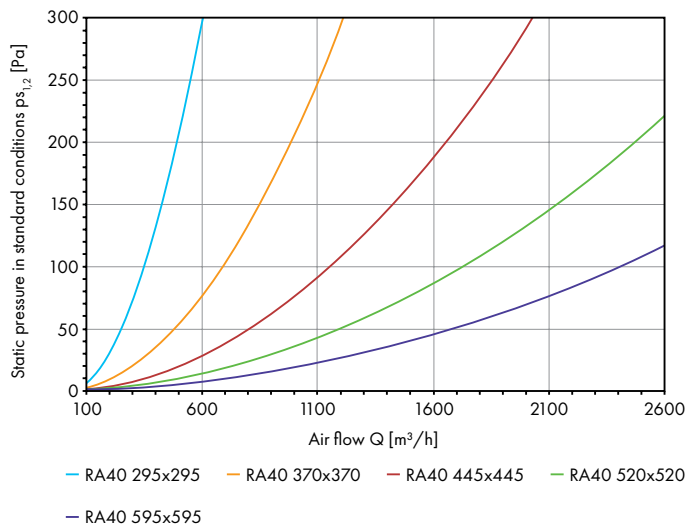

### Horizontal reach of the air jet on RA40 diffuser depending on air flow rate

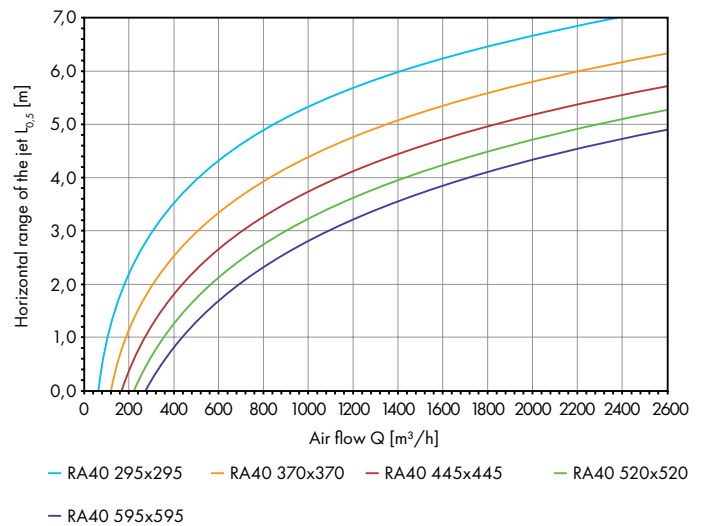

### Vertical reach of the air jet on RA40 diffuser depending on the air flow rate

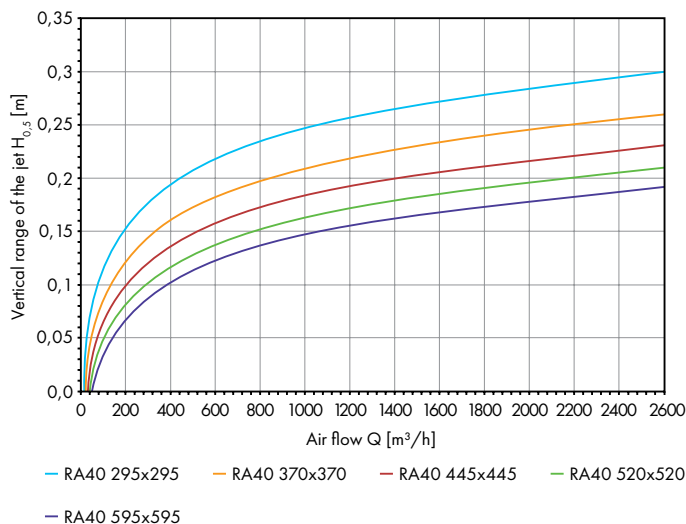

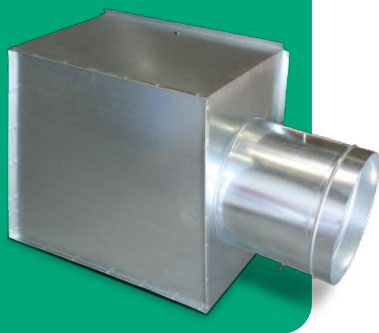

## Plenum boxes PB-RA40

### Description

Plenum box "PB-RA40" is intended for mounting diffusers "RA40". Made of galvanised steel. Boxes with individual measurements upon request.

### Types of plenum boxes

- PB-RA - Plenum box without additional equipment.
- PB-RA-P - Plenum box with manual, single blade damper.
- PB-RA-I - Plenum box with soundproof insulation made of rubber foam or mineral wool.
- PB-RA-PI - Plenum box with soundproof insulation and damper.

### Technical drawing

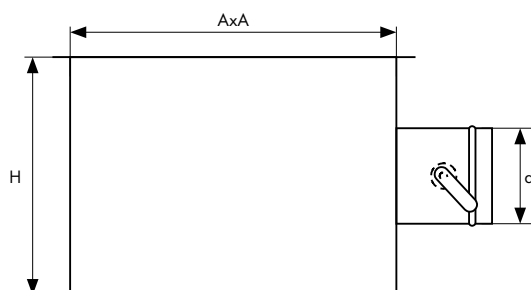

### Dimensions [mm]

Diffuser model	Dimensions AxA	Height H	Connection d
RA40 295 x 295	153 x 153	240	125
RA40 370 x 370	232 x 232	300	160
RA40 445 x 445	308 x 308	350	200
RA40 520 x 520	384 x 384	350	250
RA40 595 x 595	455 x 455	400	250

## Swirl diffusers SAC



Adjustable blades



Powder-coated in white color RAL 9016



National Technical Assessment

### Description

Swirl diffusers "SAC" HAVACO are intended for low and medium pressure ventilation systems. They are mounted in the plane of ceiling. Made of steel sheet, powder coated, finished in colour RAL 9016. A characteristic feature is the air outlet which swirls the incoming air to mix the indoor air volume with the fresh air stream. Equipped with adjustable plastic vanes (from 8 to 48 vanes, depending on the type) in order to direct the airflow. Easy assembly, standard mounting with plenum box. Designed to operate with variable or fixed airflow. Mounted in the plane of the ceiling. Made of galvanised steel, powder coated, finished in colour RAL 9016.

### Technical drawing [mm]

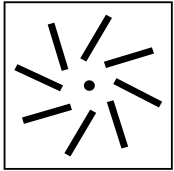

□ 300mm \* 8 vanes

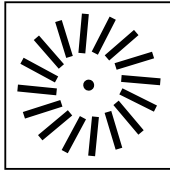

□ 400mm \* 16 vanes

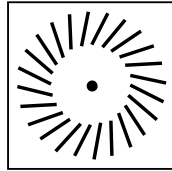

□ 500mm \* 24 vanes

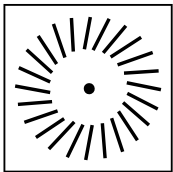

□ 600mm \* 24 vanes

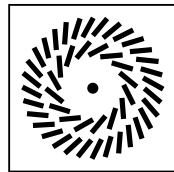

□ 600mm \* 48 vanes

### Dimensions [mm]

Model	Diffuser dimension	Model	Diffuser dimension
SAC 300/8	298x298	SAC 600/24	595x595
SAC 400/16	396x396	SAC 600/48	595x595
SAC 500/24	498x498	-	-

### Static pressure drop in standard conditions on SAC diffuser depending on air flow rate

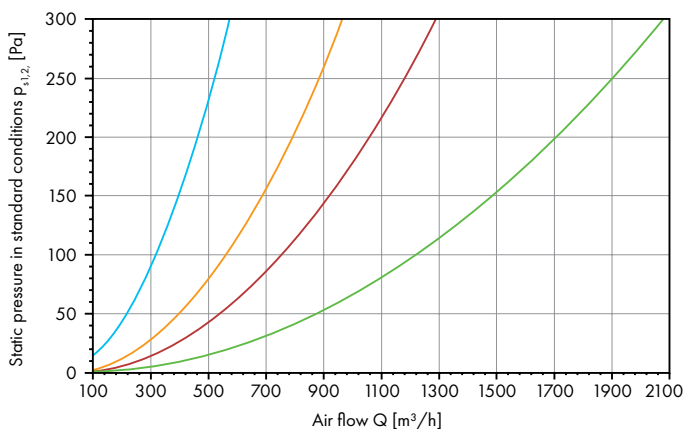

— SAC 300/8      — SAC 400/16      — SAC 500/24, SAC 600/24  
— SAC 600/48

### Horizontal reach of $L_{0,5}$ SAC jet for left-facing blades depending on air flow rate

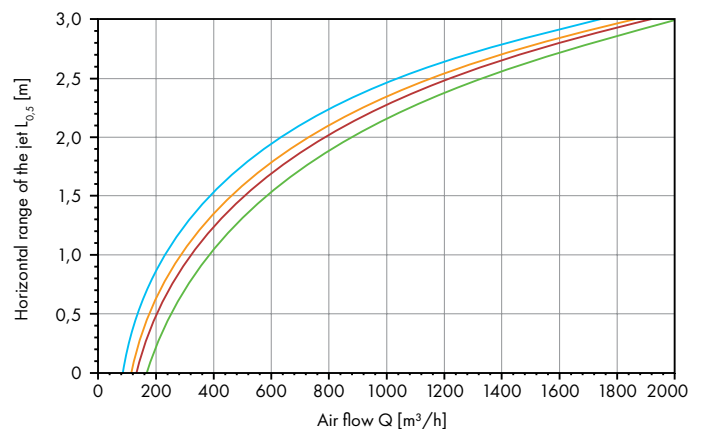

— SAC 300/8      — SAC 400/16      — SAC 500/24, SAC 600/24  
— SAC 600/48

### Vertical reach of $H_{0,5}$ SAC jet for left-facing blades depending on air flow rate

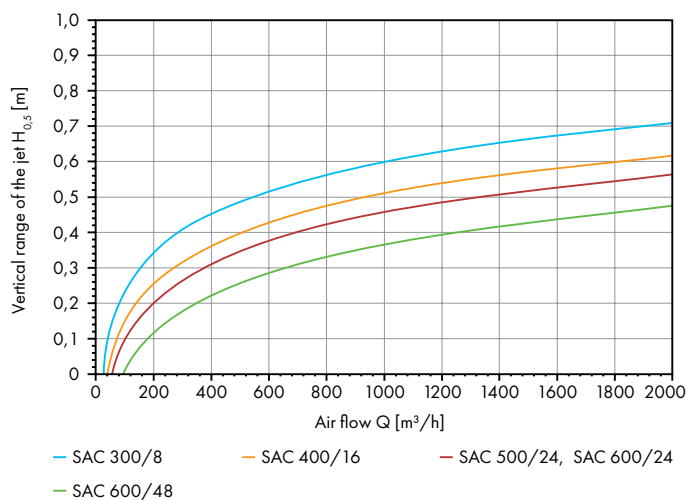

### Horizontal reach of $L_{0,5}$ SAC jet for right-facing blades depending on air flow rate

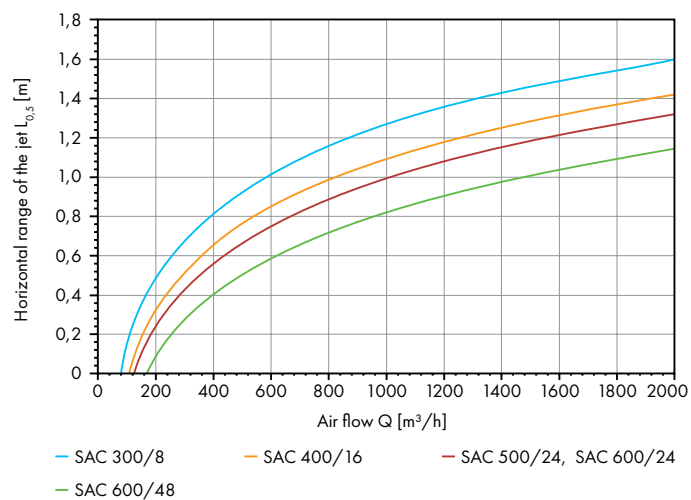

### Vertical reach of $H_{0,5}$ SAC jet for right-facing blades depending on air flow rate

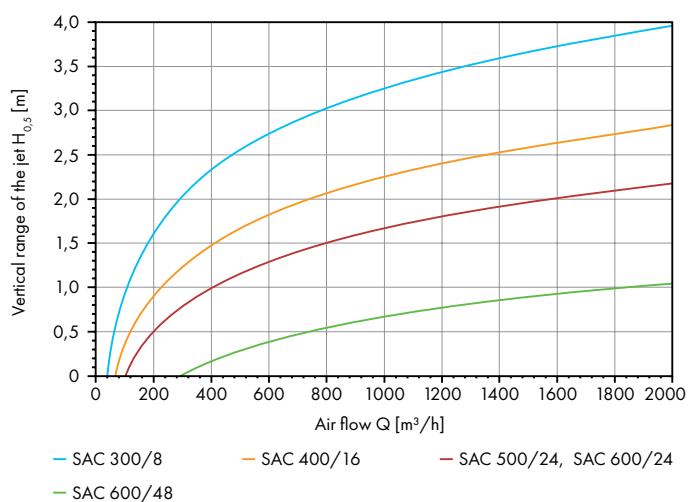



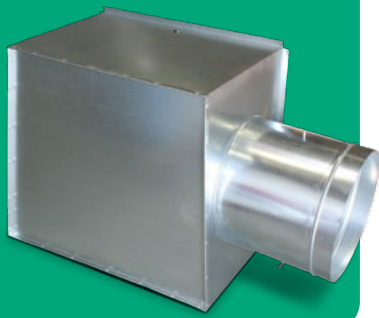

## Plenum boxes **PB-SA-C**

### Description

Plenum box "PB-SA-C" is intended for mounting diffusers "SA-C". Made of galvanised steel. Boxes with individual measurements upon request.

### Types of plenum boxes

- PB-SA-C - Plenum box without additional equipment.
- PB-SA-C-P - Plenum box with manual, single blade damper.
- PB-SA-C-I - Plenum box with soundproof insulation made of rubber foam or mineral wool.
- PB-SA-C-PI - Plenum box with soundproof insulation and damper.

### Technical drawing

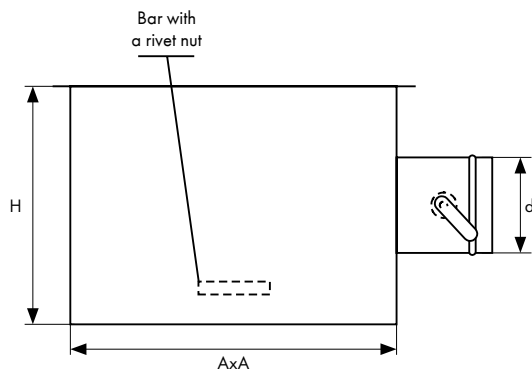

### Dimensions [mm]

Diffuser model	Dimension AxA	Height H	Connection d
SA-C 300	285 x 285	250	160
SA-C 400	367 x 367	300	200
SA-C 500	455 x 455	300	200
SA-C 600 (24 vanes)	560 x 560	320	250
SA-C 600 (48 vanes)	580 x 580	320	250



## Swirl diffusers SA-B



Universal outer dimension  
595x595 mm



Powder-coated in white color  
RAL 9016



Swirling air flow



National Technical Assessment

### Description

Swirl diffusers "SA-B" HAVACO are designed for consistent direction and distribution of an indoor airflow. Adapted to low and medium pressure air supply systems and spaces with a maximum ceiling height of 4 m. The air is distributed through 24 radial guiding vanes. Its advantages are great air distribution and low airflow noise. Assembly on ventilation ducts to plenum boxes, and into suspended ceilings. Diffusers have a central fixing screw hole. They are light and easy to install, without the need to reinforce the suspended ceiling construction. Made of steel sheet, powder coated, finished in colour RAL 9016.

### Technical drawing

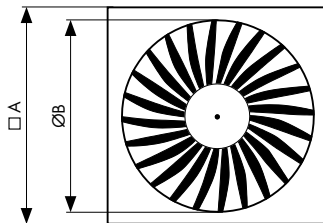

### Dimensions [mm]

Model	□ A	∅B
SA-B 300	595	254
SA-B 400	595	336
SA-B 500	595	440
SA-B 600	595	530

### Static pressure under standard conditions at the SA-B air diffuser depending on the air flow rate

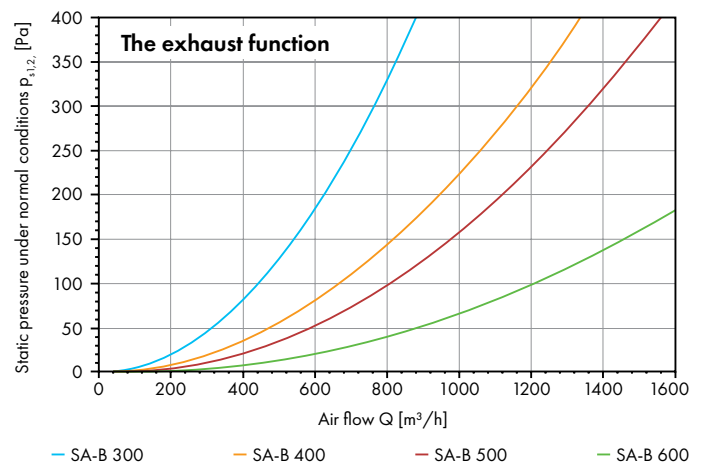
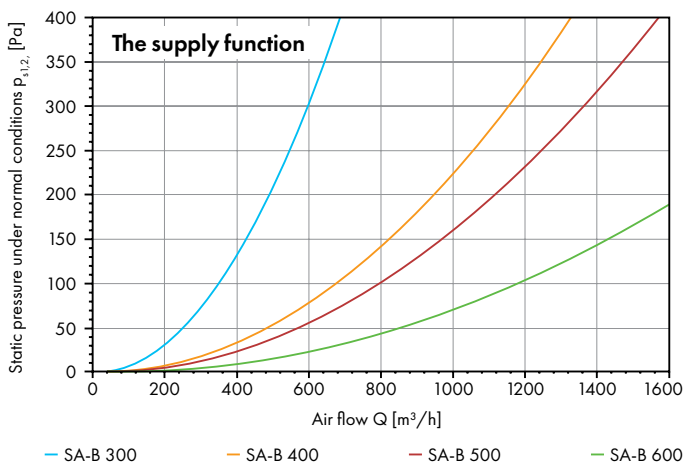

### Horizontal range of the jet on the SA-B air diffuser depending on the air flow rate

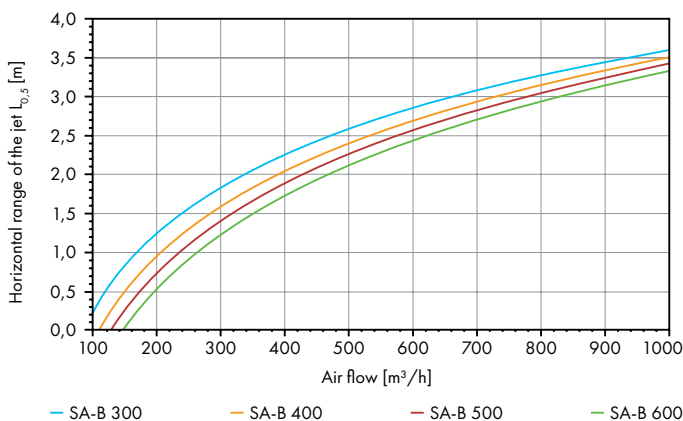

### Vertical range of the jet on the SA-B air diffuser depending on the air flow rate

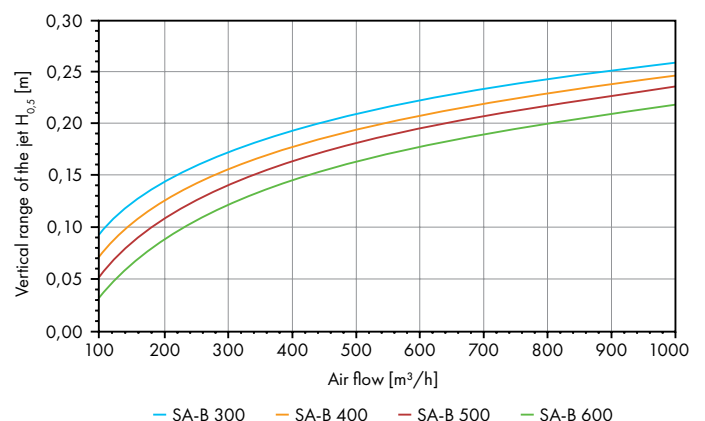

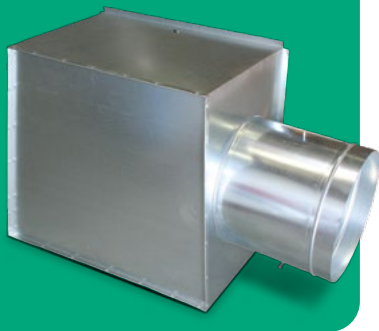

## Plenum boxes **PB-SA-B**

### Description

Plenum box "PB-SA-B" is intended for mounting diffusers "SA-B". Made of galvanised steel. Boxes with individual measurements upon request.

### Types of plenum boxes

- PB-SA-B - Plenum box without additional equipment.
- PB-SA-B-P - Plenum box with manual, single blade damper.
- PB-SA-B-I - Plenum box with soundproof insulation made of rubber foam or mineral wool.
- PB-SA-B-PI - Plenum box with soundproof insulation and damper.

### Technical drawing

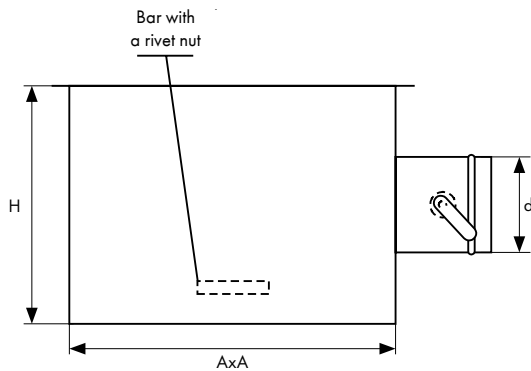

### Dimensions [mm]

Diffuser model	Dimension AxA	Height H	Connection D
SA-B 300	265 x 265	250	160
SA-B 400	347 x 347	300	200
SA-B 500	447 x 447	350	250
SA-B 600	540 x 540	400	250



# Swirl diffuser SW



Universal outer dimension  
595x595 mm



Powder-coated in white color  
RAL 9016



National Technical Assessment

## Description

Swirl diffusers "SA-B" HAVACO are designed for right direction and distribution of an indoor airflow. Adapted to low and medium pressure air supply systems and spaces with a maximum ceiling height of 4 m. The air is distributed through 36 radial guiding vanes. Its advantages are great even air distribution and low airflow noise. Assembly on ventilation ducts to plenum boxes, and into suspended ceilings. Diffusers have a central fixing screw hole. They are light and easy to install, without the need to reinforce the suspended ceiling construction. Made of steel sheet, powder coated, finished in colour RAL 9016.

## Technical drawing

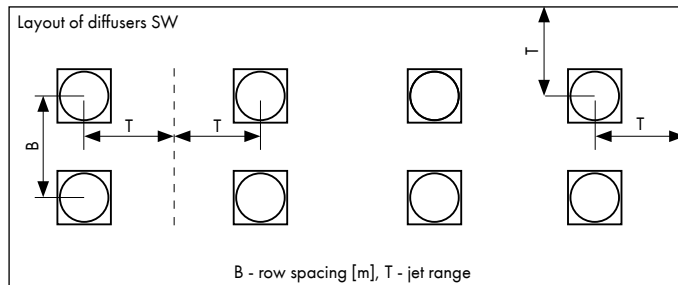
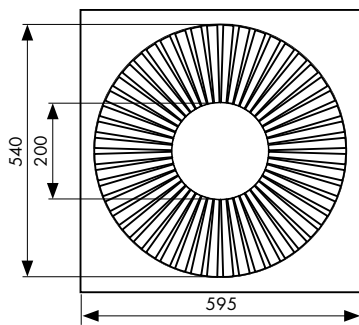

## Air jet range from the diffuser for a speed of 0.5 m/s and different air volumes

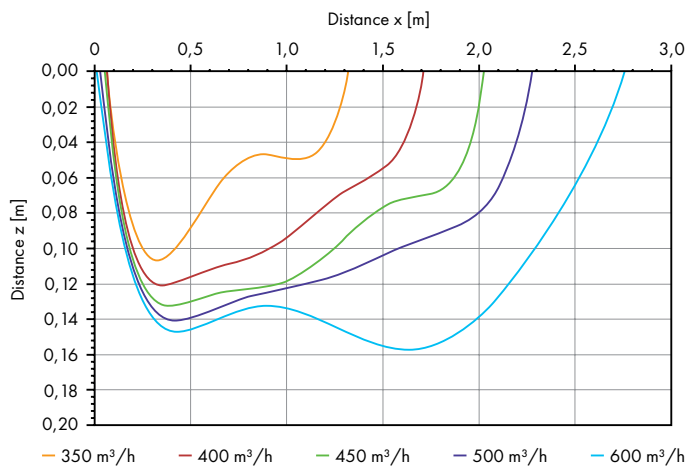

## Speed distribution in the plane of Z = 0.05 m below the ceiling for different flow rates

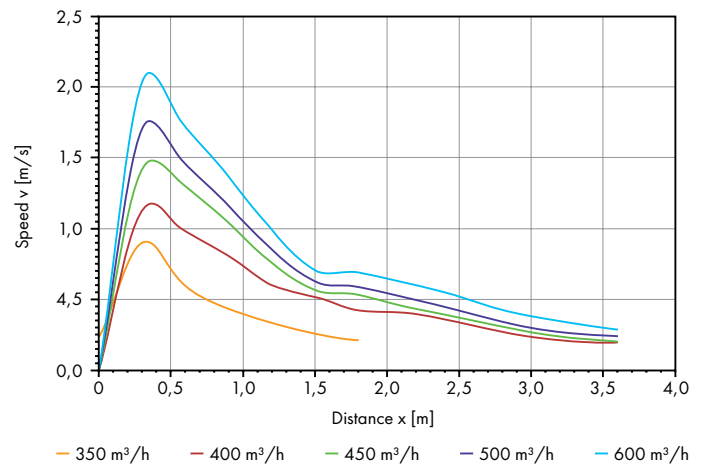

## Static pressure drop under standard conditions at the SW air diffuser depending on the air flow rate

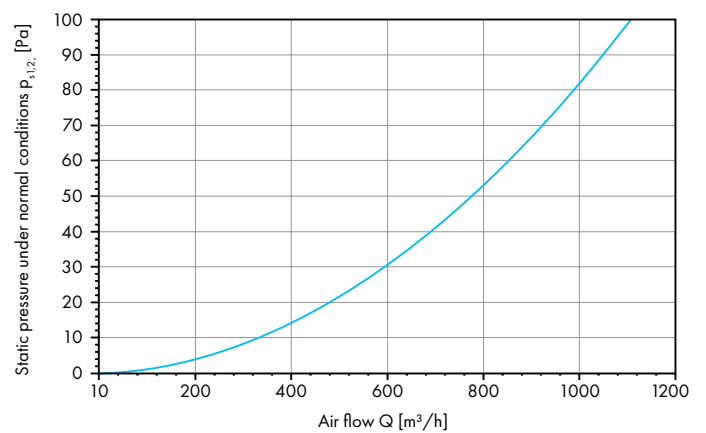



## Circular diffuser CA



Equipped with a damper



Lightweight, aluminium



Removable center

### Description

Supply air circular diffusers "CA" are designed for low and medium pressure ventilation systems, and air supply and exhaust conditioning systems. Designed to operate with variable or fixed airflow. Swirl diffusers are light and easy to install. Made of powder coated aluminium, finished in colour RAL 9016. Equipped with damper regulating air flow.

### Technical drawing

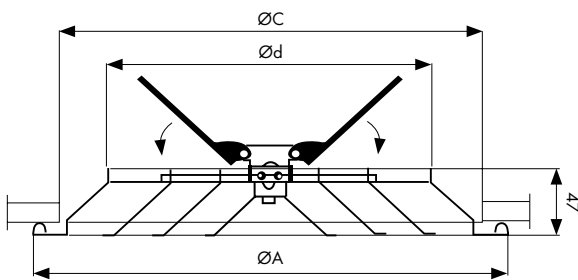

### Dimensions [mm]

Model	ØA	Ød	ØC
CA 150	257	149	225
CA 200	307	199	257
CA 250	357	249	325
CA 300	407	299	375
CA 350	457	349	425

### Characteristics

Air volume [m <sup>3</sup> /h]	Diffuser model	CA 160	CA 200	CA 250	CA 300	CA 350
150	Speed v [m/s]	4,12	1,79	1,16	0,81	0,6
	Ps [Pa]	13	4	3	2	2
	T <sub>0,50</sub> [m]	0,75	0,49	0,4	0,33	0,29
	T <sub>0,25</sub> [m]	1,25	0,92	0,79	0,7	0,64
	NC [dB(A)]	<15	<15	<15	<15	<15
200	Speed v [m/s]	5,5	2,39	1,55	1,08	0,81
	Ps [Pa]	22	6	3	3	2
	T <sub>0,50</sub> [m]	1	0,66	0,53	0,44	0,38
	T <sub>0,25</sub> [m]	1,59	1,13	0,96	0,85	0,77
	NC [dB(A)]	<15	<15	<15	<15	<15
250	Speed v [m/s]	6,87	2,99	1,94	1,35	1,01
	Ps [Pa]	33	8	4	3	3
	T <sub>0,50</sub> [m]	1,24	0,82	0,66	0,55	0,48
	T <sub>0,25</sub> [m]	1,92	1,35	1,14	0,99	0,89
	NC [dB(A)]	32	18	<15	<15	<15
300	Speed v [m/s]	8,25	3,59	2,32	1,61	1,21
	Ps [Pa]	47	10	5	4	3
	T <sub>0,50</sub> [m]	1,49	0,99	0,99	0,66	0,57
	T <sub>0,25</sub> [m]	2,25	1,57	1,32	1,14	1,02
	NC [dB(A)]	37	24	<15	<15	<15
350	Speed v [m/s]	9,62	4,18	2,71	1,88	1,41
	Ps [Pa]	63	13	7	4	3
	T <sub>0,50</sub> [m]	1,74	1,15	0,93	0,77	0,67
	T <sub>0,25</sub> [m]	2,58	1,79	1,49	1,29	1,15
	NC [dB(A)]	41	28	18	<15	<15

T [m] - range given for speed 0,50 m/s, 0,25 m/s

Ps [Pa] - static pressure

NC [dB] - noise level with assumed room sound attenuation of 10 dB



## Circular mounting connector **CA-P**

### Description

Intended for mounting circular diffuser "CA". Made of galvanized steel. Enables quick and easy diffuser's assembly in the ceiling, and connection between the diffuser and ventilation or air conditioning systems.

### Technical drawing

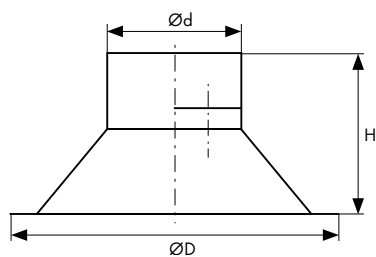

### Dimensions [mm]

Model	$\varnothing d$	H	$\varnothing D$
CA-P 150	159	140	257
CA-P 200	199	140	307
CA-P 250	249	140	357
CA-P 300	315	140	407
CA-P 350	349	140	457



# Linear slot diffuser LD



Adjustable handlebars



Made of aluminium

## Description

Aluminium linear slot diffusers "LD" enables a suitable exhaust airflow guide, providing high flexibility in application. Each slot enables separate air flow direction adjustment and is provided with two deflector vanes. Adjusted to supply warm and cold air. Convenient exhaust regulation ensures effectiveness of variable output systems. As standard, in simple modules with length of 1 m. Made of aluminium and galvanised steel (regulating components). Powder coated in colour RAL 9016.

## Technical drawing LD.2 [mm]

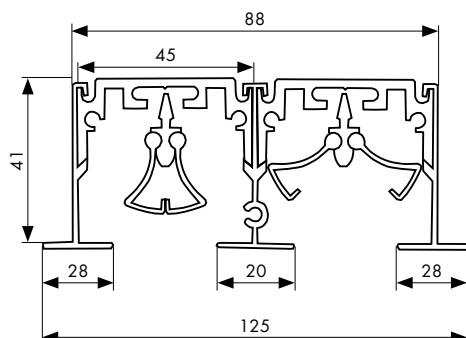

L = 1032 mm (with frame)

## Technical drawing LD.3 [mm]

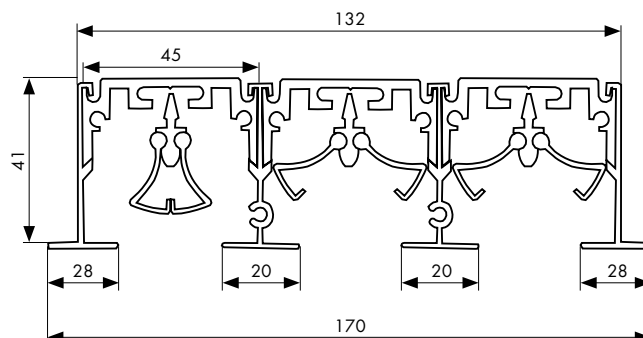

L = 1032 mm (with frame)

Direction of airflow

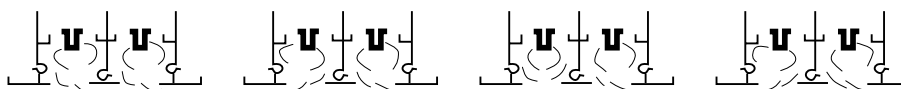

## LD.2 - Horizontal range of the jet $L_{0,5}$ [m]

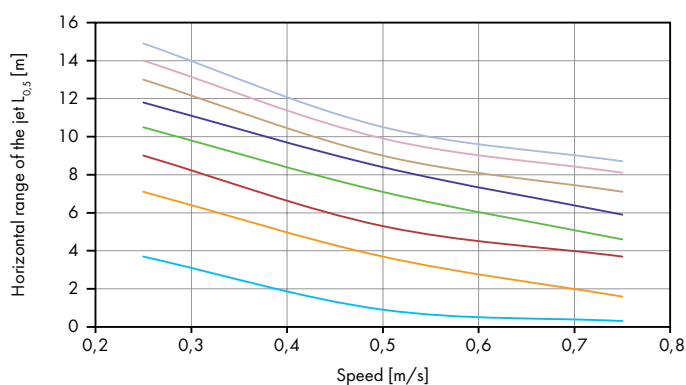

- V = 65 m<sup>3</sup>/h
- V = 130 m<sup>3</sup>/h
- V = 205 m<sup>3</sup>/h
- V = 270 m<sup>3</sup>/h
- V = 335 m<sup>3</sup>/h
- V = 400 m<sup>3</sup>/h
- V = 470 m<sup>3</sup>/h
- V = 540 m<sup>3</sup>/h

## LD.3 - Horizontal range of the jet $L_{0,5}$ [m]

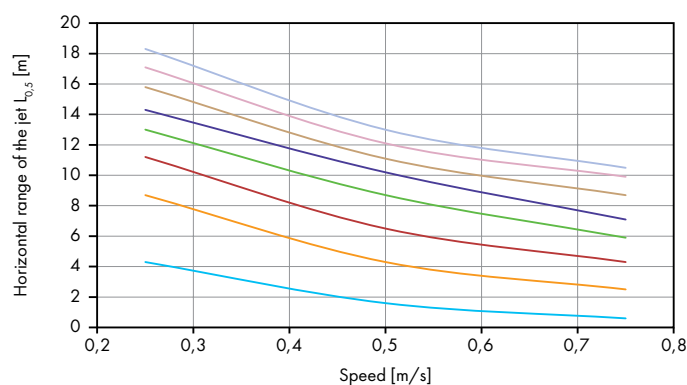

- V = 65 m<sup>3</sup>/h
- V = 130 m<sup>3</sup>/h
- V = 205 m<sup>3</sup>/h
- V = 270 m<sup>3</sup>/h
- V = 335 m<sup>3</sup>/h
- V = 400 m<sup>3</sup>/h
- V = 470 m<sup>3</sup>/h
- V = 540 m<sup>3</sup>/h



## LD.2 - Vertical range of the jet $L_{0,5}$ [m]

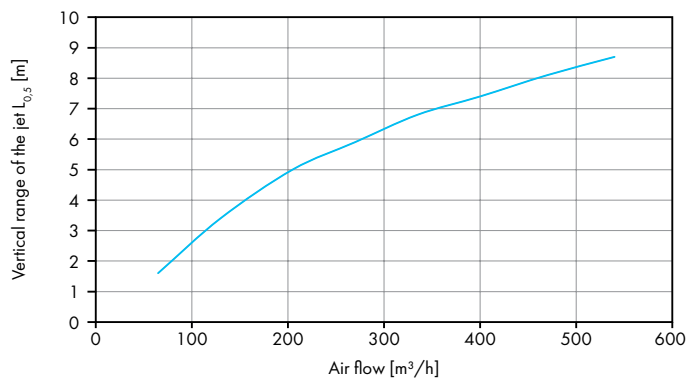

## LD.3 - Vertical range of the jet $L_{0,5}$ [m]

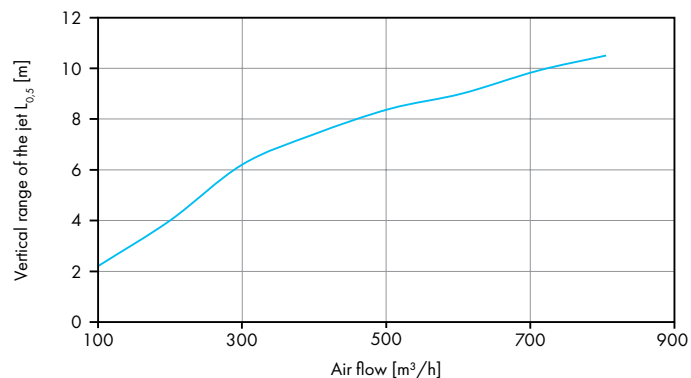

## LD.2 - Static pressure

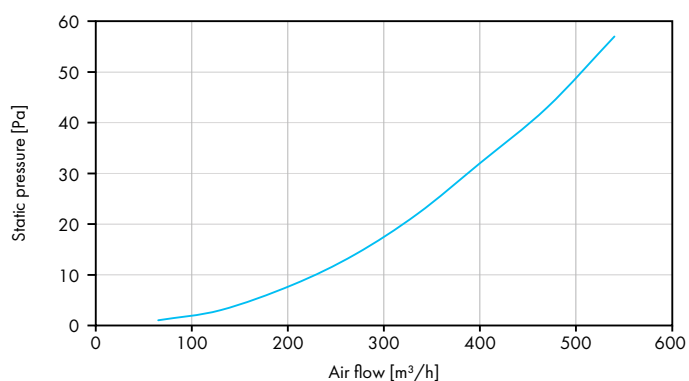

## LD.3 - Static pressure

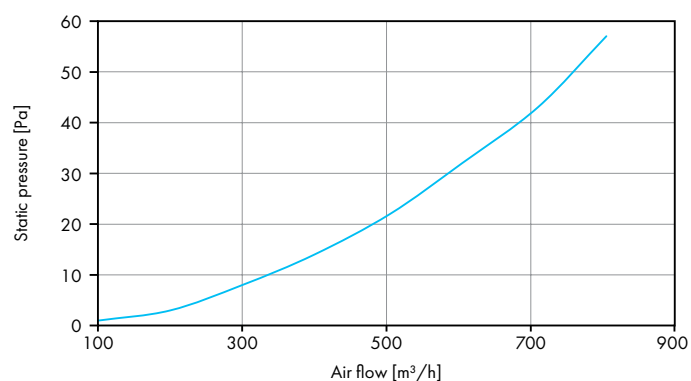

## LD.2 - Noise power level

### Model LD.2

### Characteristic

V [m³/h]	65	130	205	270
NC [dB]	-	-	16	23
V [m³/h]	335	400	470	540
NC [dB]	29	33	37	40

V [m³/h] - air volume

NC [dB] - noise level with assumed room sound attenuation of 10 dB

## LD.3 - Noise power level

### Model LD.3

### Characteristic

V [m³/h]	100	200	300	400
NC [dB]	-	-	18	25
V [m³/h]	505	605	710	805
NC [dB]	30	35	39	42

V [m³/h] - air volume

NC [dB] - noise level with assumed room sound attenuation of 10 dB

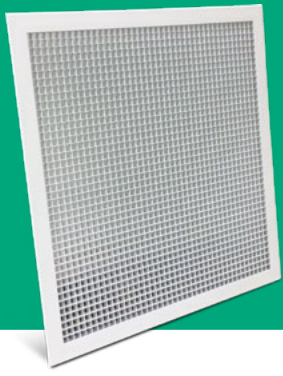

## Egg crate EGC



Universal outer  
dimension  
595x595 mm



Powder-coated  
in white color  
RAL 9016



National Technical  
Assessment

### Description

Exhaust grill made of aluminium. Finished in colour RAL 9016.

### Technical drawing

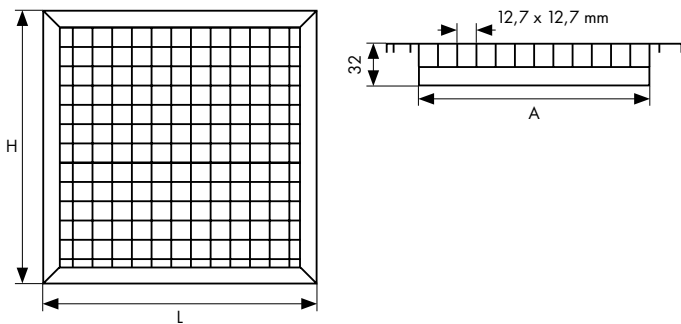

### Static pressure under normal conditions on EGC exhaust grill depending on the air flow

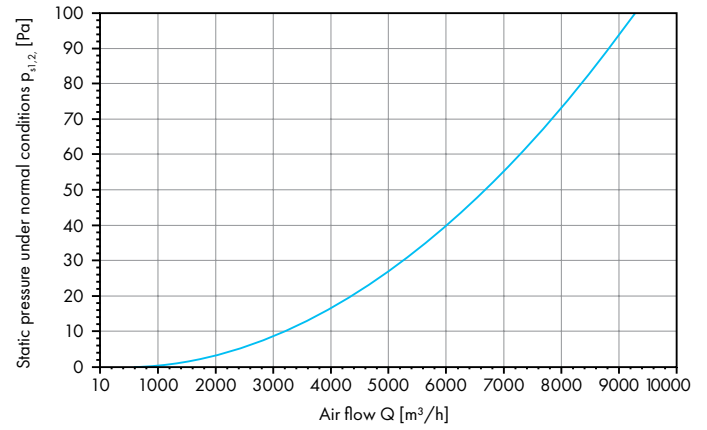

### Dimensions [mm]

Model	A	L	H
EGC 595x595	541	595	595

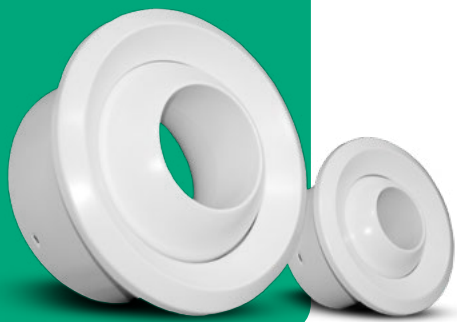

## Jet nozzle diffuser JN-S



Adjustable angle  
of inclination



Made of  
aluminium



Powder-coated  
in white color  
RAL 9016

### Description

Jet nozzle diffusers "JN-S" are used in high, large-size spaces such as theatres, cinemas, industrial halls, shopping centres etc. Low sound pressure level with high volumetric airflow quantity provides a very wide airflow range. For horizontal and vertical air supply.

The ball jet nozzle can be adjusted in any direction every 30° from the centreline; it does not affect airflow resistance or the sound pressure level.

The nozzle and decorative collar are made of aluminium, powder coated, finished in colour RAL 9016.

### Technical drawing

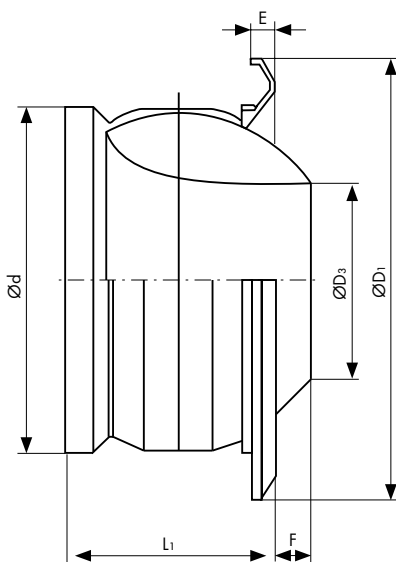

### Dimensions [mm]

Model	ØD <sub>1</sub>	Ød	ØD <sub>3</sub>	E	F	L1
JN-S 125	185	123	64	10	4	89
JN-S 160	216	158	82	11	10	106
JN-S 200	273	198	108	16	14	127
JN-S 250	318	248	136	16	23	159
JN-S 315	380	315	180	25	30	180
JN-S 400	495	400	210	24	47	218
JN-S 500	625	500	255	47	50	270

### Characteristics

Model	Jet range						Final air speed [m/s]			
	10 m		20 m		30 m					
	Air volume [m <sup>3</sup> /h]	Pressure loss [Pa]	Noise level [db(A)]	Air volume [m <sup>3</sup> /h]	Pressure loss [Pa]	Noise level [db(A)]				
JN-S 125	-	-	-	122	71	25	180	136	36	0,25
JN-S 160	82.8	11	<20	165	26	<20	250	98	35	
JN-S 200	104	-	<20	220	29	<20	306	67	27	
JN-S 250	133	-	<20	272	8,3	<20	382	34	22	
JN-S 315	180	-	<20	352	11	<20	540	39	20	
JN-S 400	234	-	<20	468	8	<20	702	13	<20	
JN-S 125	122	71	25	245	265	46	-	-	-	0,5
JN-S 160	165	26	<20	330	113	44	497	200	55	
JN-S 200	220	29	<20	435	123	38	655	218	50	
JN-S 250	274	8,3	<20	548	63	34	825	112	45	
JN-S 315	350	11	<20	682	55	28	1055	104	40	
JN-S 400	460	8	<20	914	32	20	1394	69	33	
JN-S 125	245	265	46	-	-	-	-	-	-	1,0
JN-S 160	330	113	44	-	-	-	-	-	-	
JN-S 200	435	123	38	870	312	-	-	-	-	
JN-S 250	548	63	34	1100	160	53	-	-	-	
JN-S 315	700	57	28	1400	150	48	2100	243	-	
JN-S 400	930	32	20	1860	123	42	2796	265	50	

## Air diffusers

supply with cold air

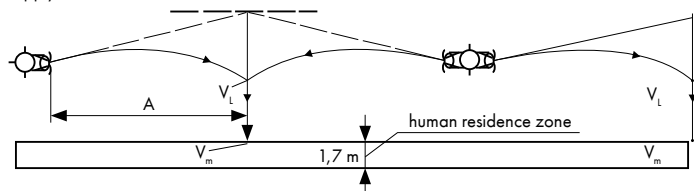

constant temperature supply

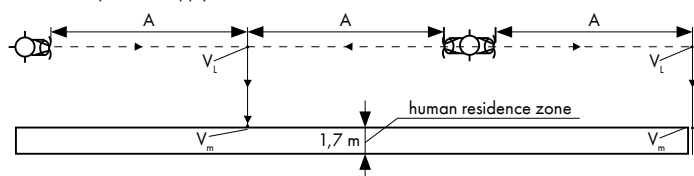

supply with warm air

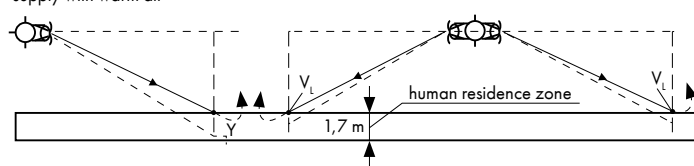

A - horizontal distance from the nozzle to the point where two streams meet

$V_L$  - the axial speed at the end of the jet

$V_m$  - average air speed in the residence zone

Y - the deflection of the air stream due to temperature differences, relative to the constant temperature air stream

## Bending of the airflow

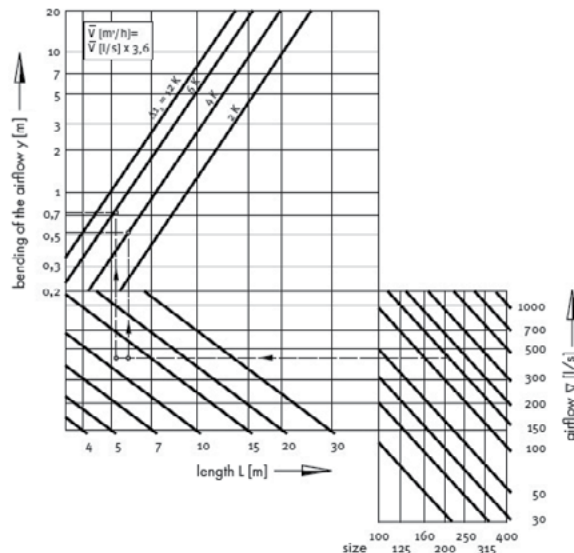

$\Delta 12$  at warm air supply, is positive, and at cold air supply, is negative.

The deflection of the stream Y is directed upwards for a warm supply air and downwards for a cold supply air.

## Grill for round duct SGD

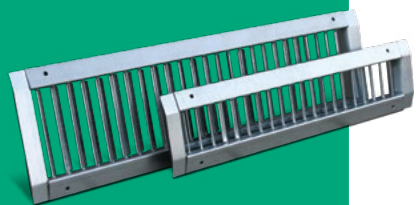

Adjustable  
handlebars



Wide range of Spiro  
duct diameters

## Description

Ventilation grills "SGD" are designed for low and medium pressure ventilation systems into circular ducts. Grill design ensures optimal direction of supply airflow, and use as an exhaust element. Grill frame and movable handlebars are made of galvanised steel.

## Technical drawing

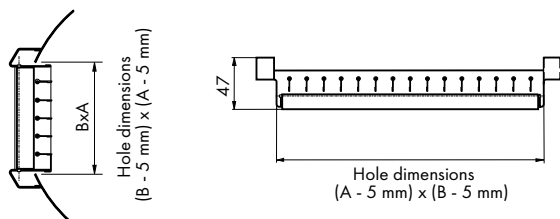

## Dimensions [mm]

Model	A	B	Duct diameter
SGD 425x75	425	75	160-400
SGD 525x125	525	125	315-800



# Flexible insulated duct IZOFLEX PRO



Lightweight,  
aluminium



Flexible



Easy  
assembly



Durable, high  
quality

## Description

Flexible insulated duct "IZOFLEX PRO", applied to usage in ventilation and air conditioning systems. Mineral wool insulation, with increased density, serves as superb thermal protection. Ducts are adapted to transport the medium at a temperature range from -30°C to 150°C.

## Usage

Flexible insulated ducts are mainly used in the end section of the air supply system, for connecting plenum boxes or diffusers. They reduce the need for ventilation fittings and specialised tools. In addition, they effectively reduce system vibration.

## Design

Internal duct is made of three-layer aluminium foil laminate with polyester, reinforced with steel wire helix. Thermally insulated with 25 mm thick mineral wool. External layer consists of two layers: laminated aluminium and polyester foil. Duct is divided into sections of 10 m and is packed in boxes with a length of 1,2 m.

## Technical drawing

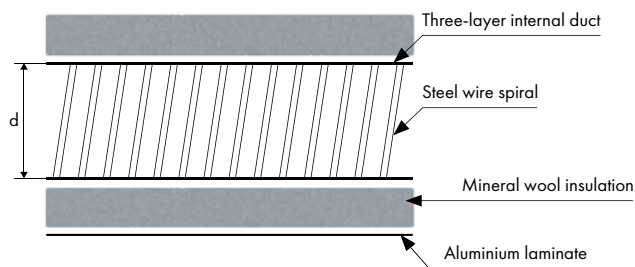

## Technical specifications

Diameter d [mm]	Temperature [°C]	Permissible pressure [Pa]	Max air speed [m/s]	Internal duct	Insulation thickness [mm]	Insulation density [kg/m <sup>3</sup> ]	Thermal resistance of insulation [m <sup>2</sup> K/W]	Outer sheath	Length	Fire reaction class
102	-30 / +150	2500	30	Three-layer laminate of aluminium foil with polyester, reinforced with a spiral of steel wire	25	12	0,55	laminated aluminium, polyester film	10 m ± 2%	UK (BS476): Part 7 Class 1 Part 6 Class 0 EU (EN 13501-1): B-s1, d0 FR (NF): M1 (ASTM-E - 84/UL723)
127	-30 / +150	2500	30		25	12	0,55		10 m ± 2%	
165	-30 / +150	2500	30		25	12	0,55		10 m ± 2%	
203	-30 / +150	2500	30		25	12	0,55		10 m ± 2%	
254	-30 / +150	2500	30		25	12	0,55		10 m ± 2%	
318	-30 / +150	2500	30		25	12	0,55		10 m ± 2%	



## Flexible duct without insulation **ALUFLEX 3.0**



Lightweight,  
aluminium



Flexible



Easy  
assembly



Durable, high  
quality

### Description

Duct "ALUFLEX 3.0" HAVACO is a flexible, non-insulated duct, applied to usage in ventilation and air conditioning systems. Ducts are adapted to transport the medium at a temperature range: from -30°C to 130°C.

### Usage

Non-insulated ducts are mainly used in the end section of the air supply system, for connecting plenum boxes or diffusers. They eliminate the need for ventilation fittings and specialised tools. In addition, they effectively reduce noise level.

### Design

Internal duct is made of three-layer aluminium foil laminate with polyester, enhanced with steel wire helix. Duct is divided into sections of 10 m and is packed in boxes with a length of 0,5 m.

### Technical drawing

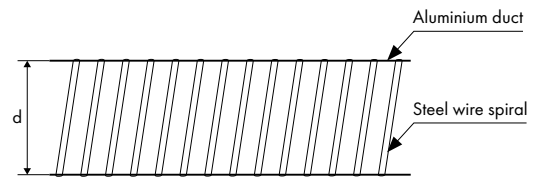

### Technical specifications

Diameter d [mm]	Temperature [°C]	Permissible pressure [Pa]	Max air speed [m/s]	Internal duct	Wire spacing in ducts [mm]	Length	Fire class
83	-30 / +130	2500	30	Three-layer laminate of aluminium foil with polyester, reinforced with a spiral of steel wire	24	10 m ± 2%	EN13501-1: NPD, CSTB: M1, LAPI: CLASS 1
102	-30 / +130	2500	30		24	10 m ± 2%	
127	-30 / +130	2500	30		30	10 m ± 2%	
163	-30 / +130	2500	30		42	10 m ± 2%	
203	-30 / +130	2500	30		42	10 m ± 2%	
254	-30 / +130	2500	30		42	10 m ± 2%	
315	-30 / +130	2500	30		42	10 m ± 2%	



## Semi-flexible duct without insulation **SEMIFLEX**



Lightweight,  
aluminium



Easy  
assembly



Flexible



Durable, high  
quality

### Description

High quality duct "SEMIFLEX" is a semi-flexible, non-insulated duct, applied to usage in low and medium pressure ventilation and air conditioning systems. After installation, it retains its shape. Good mechanical resistance, easy assembly. Standard length of 3 m, package size 0,9 m.

### Usage

Ducts SEMIFLEX are used to distribute airflow in ventilation and air conditioning systems. They can also be applied for exhaust ventilation in extractor hoods.

### Design

Duct is made of spiro aluminium foil. Maximum operating temperature +200 °C. Standard length of 3 m, packed in foil, package size with a length up to 0,9 m.

### Technical drawing

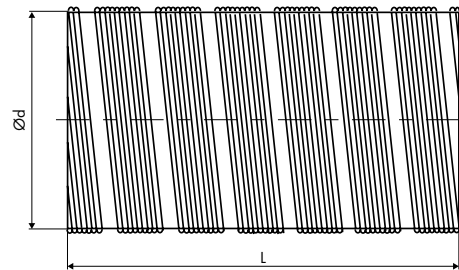

### Dimensions [mm]

$d_{nom}$	$\varnothing d$	L	$d_{nom}$	$\varnothing d$	L
80	83	3000	200	204	3000
100	103	3000	250	254	3000
125	128	3000	315	319	3000
150	154	3000	355	359	3000
160	164	3000	400	406	3000

### Technical specifications

Duct material	Aluminium
Diameter range	80 - 400 mm
Maximum operating temperature	+200 °C
Maximum air speed	25 m/s
Maximum working pressure	2000 Pa
Standard length	3 m
Length of the compressed duct	0,9 m

# Circular acoustic silencer

## TAO

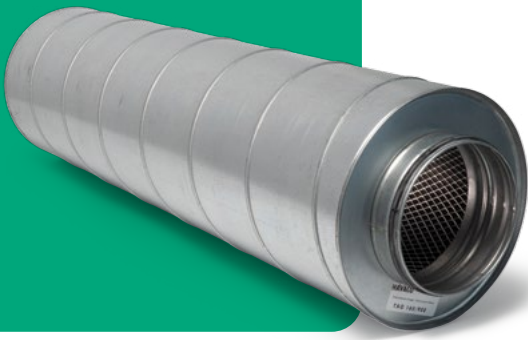

High effectiveness suppression



Double gasket, tightness class D

### Description

Acoustic silencers "TAO" are made according to the standard PN-EN 12237. Its case is made from spiro duct, dampening inside (mineral wool) protected with perforated mesh. Circular male end. HAVACO silencers are made with a gasket. EPDM clamped automatically ensures no risk of slipping during mounting. Material: galvanised steel, on request available stainless steel 1.4301 and 1.4404.

### Technical drawing

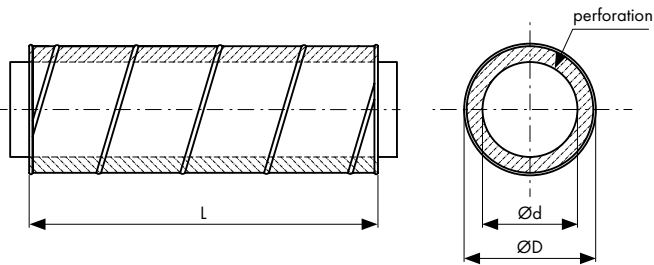

### Dimensions L=600, L=900 [mm]

Model	ØD	Ød nom	Model	ØD	Ød nom
TAO 100	200	100	TAO 355	450	355
TAO 125	224	125	TAO 400	500	400
TAO 160	280	160	TAO 450	560	450
TAO 200	315	200	TAO 500	630	500
TAO 250	355	250	TAO 560	630	560
TAO 315	400	315	TAO 630	710	630

### Attenuation characteristics

Model	Ød nom	L	Thickness of acoustic insulation	Sound attenuation (dB) for center frequency (Hz)							
				63	125	250	500	1000	2000	4000	8000
TAO 100	100	600	50 mm	11	7	12	29	37	45	42	24
		900		11	9	17	39	44	47	45	30
TAO 125	125	600	50 mm	4	7	10	25	30	39	36	20
		900		6	8	13	35	44	48	46	25
TAO 160	160	600	50 mm	3	5	7	21	24	35	27	18
		900		6	6	9	30	35	46	33	22
TAO 200	200	600	50 mm	3	3	6	19	22	29	21	16
		900		7	5	9	26	28	42	28	20
TAO 250	250	600	50 mm	7	2	4	15	18	25	17	17
		900		6	3	6	21	27	34	22	18
TAO 315	315	600	50 mm	1	2	4	12	16	19	16	15
		900		3	3	5	18	24	26	18	17
TAO 355	355	600	50 mm	2	2	6	11	14	19	15	15
		900		2	3	7	14	26	22	19	26
TAO 400	400	600	50 mm	2	2	6	20	22	21	20	15
		900		3	2	7	25	28	26	22	13
Tolerance ±				2	2	2	2	2	2	3	3





# Flexible acoustic silencer AKUFLEX



Insulation  
25 or 50 mm



Flexible

## Description

Flexible acoustic silencer "AKUFLEX" is designed for flexible connections in ventilation systems. "AKUFLEX" consists of a multi-layer perforated corrugated air exhaust duct made of aluminium, and outer layer with Polyethylene cover (PE). Space between internal and external duct is filled with 25 or 50 mm mineral, sound absorbing wool. Silencer is finished with metal stub end coupling, which facilitates installation.

Silencer is compressed when delivered and should be extended to full length for best possible sound absorption.

## Technical drawing

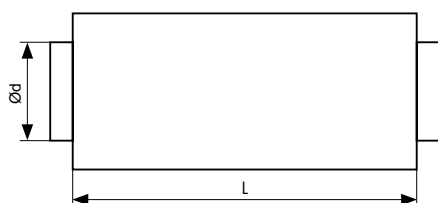

## Dimensions [mm]

Ød nom	L	Ød nom	L
100	600 or 1200	200	600 or 1200
125	600 or 1200	250	600 or 1200
160	600 or 1200	315	600 or 1200

## Design

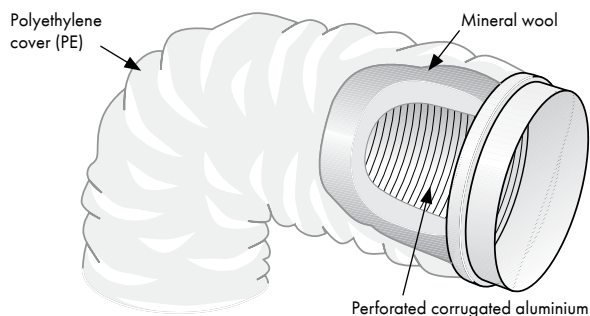

## Technical specifications

<b>Color</b>	Grey
<b>Material</b>	Internal conductor: perforated corrugated aluminium External conductor: polyethylene cover (PE) Insulation: mineral wool (25 or 50 mm thickness)
<b>Max temperature range</b>	+80 °C
<b>Pressure</b>	max 1000 Pa
<b>Standard length</b>	L = 0,6 m or 1,2 m
<b>Sleeves ends</b>	female-to-female

## Noise attenuation, L = 0.6 m, mineral wool 25 mm

ØD [mm]	Attenuation value, dB - mid-frequency range, Hz							
	63	125	250	500	1000	2000	4000	8000
100	27	21	31	27	24	20	9	7
125	25	20	25	22	20	20	10	8
160	20	14	20	19	17	17	8	6
200	23	13	18	13	12	15	7	5
250	19	15	17	12	12	17	7	5
315	16	13	13	8	10	10	5	3

## Noise attenuation, L = 1.2 m, mineral wool 25 mm

ØD [mm]	Attenuation value, dB - mid-frequency range, Hz							
	63	125	250	500	1000	2000	4000	8000
100	33	27	35	33	37	42	33	16
125	26	30	34	29	34	40	38	17
160	17	20	30	28	28	37	36	14
200	13	20	30	23	24	35	23	14
250	25	28	22	17	19	21	8	7
315	28	21	18	15	17	17	8	6

## Characteristics

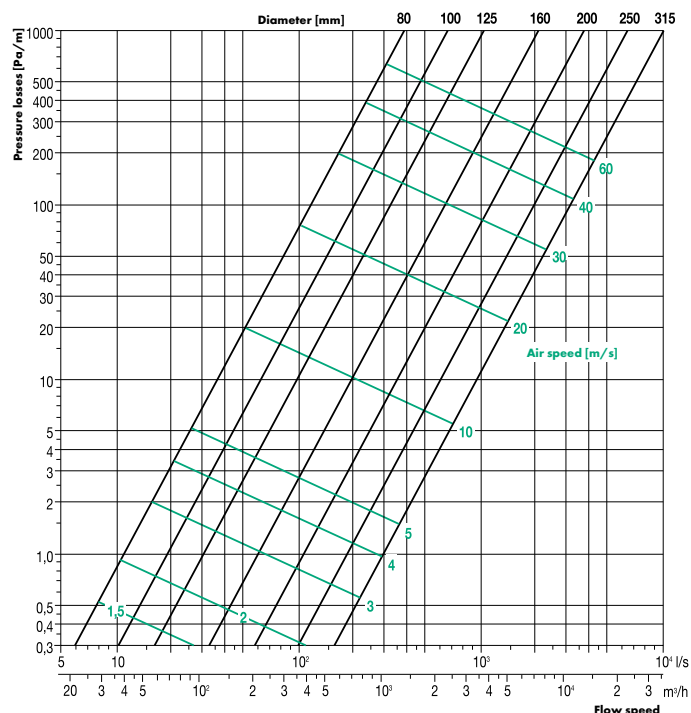



# Flexible acoustic silencer AKUDEC



Insulation  
25 mm



Flexible

## Description

Flexible acoustic silencer "AKUDEC" is made of multi-layer perforated corrugated aluminium. Inner duct with a aluminium laminate outer cover. Space between internal and external duct is filled with 25 mm mineral, sound absorbing wool. On request, silencer AKUDEC is available with 50 mm glass wool. The silencer is finished with galvanized metal sleeves with rubber gasket on both ends, which greatly facilitates installation.

Available sleeves ends: male-to-male.

## Technical drawing

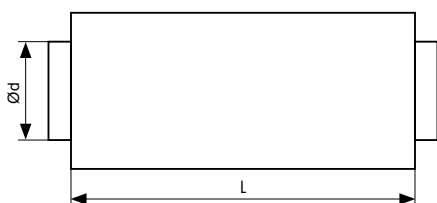

## Dimensions [mm]

ØD nom	D	L	Tolerance
100	99,3	1000	+0; -0,5
125	124,7	1000	+0; -0,5
160	159,3	1000	+0; -0,6
200	199,3	1000	+0; -0,7
250	249,3	1000	+0; -0,8
315	314,3	1000	+0; -0,9

## Technical specifications

Color	Aluminium
Material	Internal conductor: perforated corrugated aluminium External conductor: aluminium foil laminated with polyester Insulation: mineral wool (25 mm thickness)
Max temperature range	-30 ~ +140 °C
Pressure	max 2000 Pa
Operating air velocity	max 10 m/s
Standard length	L = 1 m
Sleeves end	Galvanized steel + EPDM gasket
Fire class	A1

## Sound attenuation, L = 1 m, mineral wool 25 mm

Ød [mm]	Attenuation value, dB - mid-frequency range, Hz							D <sub>i</sub> [dB]	
	63	125	250	500	1000	2000	4000		8000
100	9,5	14,5	28,6	37,4	35,6	39,8	44,3	29,5	36
125	12,4	20,1	33,6	29,8	29,5	33,6	32,1	23,6	32
160	14,6	19,1	31,1	27,0	24,7	32,5	24,0	18,7	29
200	11,1	14,6	29,5	20,7	21,0	30,0	17,7	13,2	23
250	14,2	21,7	23,1	18,9	18,4	25,7	11,4	10,1	20
315	10,8	21,9	17,9	15,5	17,7	16,7	9,2	9,3	17

NOTE: D<sub>i</sub> - average attenuation value

## Characteristics

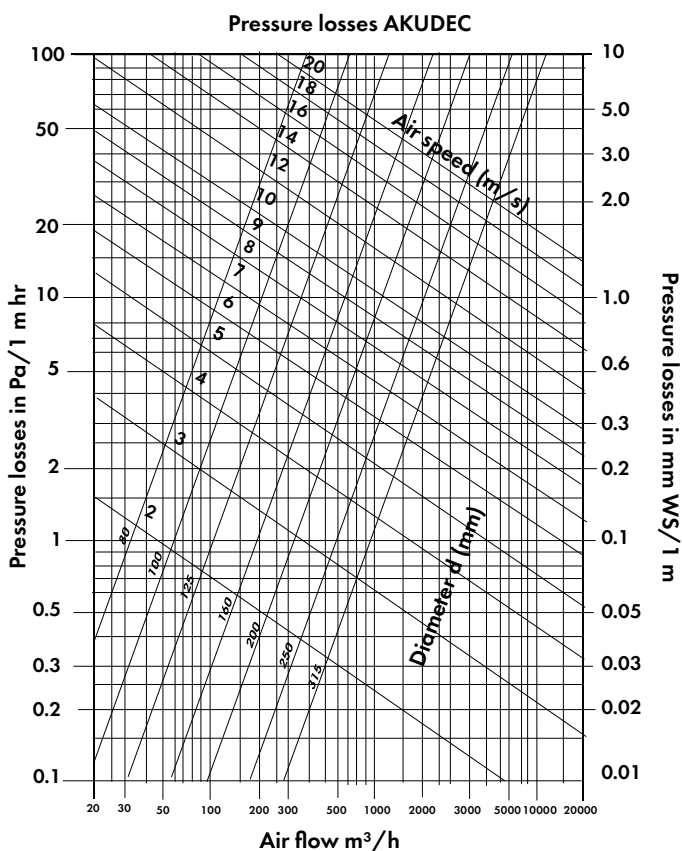

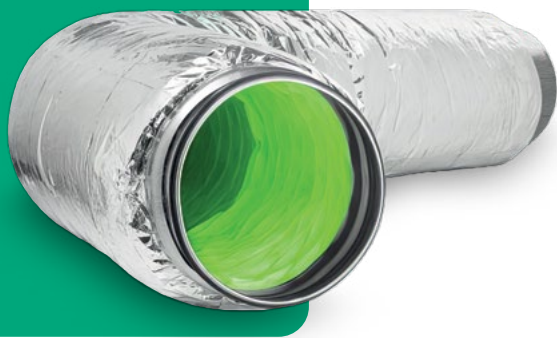

## Flexible acoustic silencer with thermal insulation **GREENDEC® Sanitized®**



### Description

The GREENDEC® Sanitized® flexible silencer with thermal insulation features a unique inner duct that stands out in the market. It is coated with DEC's patented hygienic function Sanitized®, which effectively reduces the growth of bacteria, microorganisms, and fungi inside the silencer. It can be considered the most hygienic flexible silencer currently available on the market.

### Anti-microbe protection



GREENDEC® Sanitized® features an internal duct made of polypropylene fabric, coated with the patented, hygienic Sanitized® antibacterial coating. This coating reduces the growth of bacteria, microorganisms, and fungi, thereby reducing unpleasant odors and, more importantly, protecting the health of the ventilation system users. It ensures the supply of cleaner air compared to standard flexible silencers. Thanks to the Sanitized® coating, the interior of the silencer does not provide conditions conducive to the development of bacteria, fungi, and other microorganisms.

### GREENDEC® Sanitized® properties

Internal duct made of Sanitized® polypropylene fabric.

The integrated Sanitized® antibacterial hygienic coating provides 24-hour protection against bacteria and unpleasant odors.

Compliance with BPR PT9, for more information, see: [www.sanitized.com](http://www.sanitized.com).

The hygienic coating does not age and is resistant to temperature.

The material is resistant to moisture penetration.

### Application

End sections of domestic ventilation systems, from the steel spiro ducts to the air diffuser.

Connecting the recuperator to distribution boxes (max 1 m).

Connecting the ventilation system to the plenum box.

### Technical data

#### Temperature range:

Inside -30 °C do 90 °C

Outside -30 °C do 140 °C

Working pressure up to +2000 Pa

Maximum airflow speed max. 30 m/s

Minimum bending radius 0.54 x Ø + 25 mm

Diameter range 80 - 315 mm

Standard length 1 or 3 meters

Appearance Aluminium

### Construction

Inner duct High-tech polypropylene fiber with Sanitized® coating

Glass wool 25 or 50 mm, 16 kg/m³

R-value of wool 0.65 m² K/W (ASTM C177-76)

Outer jacket Aluminum/polyester

Fire reaction classification According

ISO 184 Method A 0

ISO 184 Method C 0

EU (EN 13501-1) B-s1d0

Greendec®-type Connectdec® meets all requirements and is classified according to standard EN 13180: Ventilation for buildings – Ductwork – Dimensions and mechanical requirements for flexible ducts.

## Acoustic properties without DEC@TECH barrier and with standard aluminum outer jacket:

### Sound attenuation, according to ISO 7235, $\pm 2$ dB

GREENDEC 25, Length: 1 meter

Glass wool insulation 25 mm (Test report no. A1672-1 Peutz bv - The Netherlands)

ØD [mm]	L (m)	Attenuation, dB - Average frequency, Hz								D <sub>i</sub> [dB]
		63	125	250	500	1000	2000	4000	8000	
080	1,0	13,6	22,4	40,2	38,7	36,5	41,3	51,6	45,8	39
100	1,0	15,9	22,9	31,1	38,6	36,4	40,6	50,1	35,9	39
125	1,0	11,7	18,9	32,4	29,9	28,8	34,5	40,9	24,5	32
150	1,0	12,2	10,9	29,7	30,1	29,0	38,3	34,6	20,4	32
160	1,0	19,3	25,4	30,5	27,1	23,8	32,2	27,8	17,3	28
200	1,0	10,7	12,1	28,7	22,8	22,8	30,6	19,4	11,9	26
250	1,0	12,9	18,7	24,3	19,5	19,9	27,7	12,9	10,2	22
315	1,0	16,6	23,2	18,0	15,2	16,5	19,6	10,1	8,5	17

GREENDEC 50, Length: 1 meter

Glass wool insulation 50 mm

ØD [mm]	L (m)	Attenuation, dB - Average frequency, Hz								D <sub>i</sub> [dB]
		63	125	250	500	1000	2000	4000	8000	
100	1,0	4,3	8,5	15,5	28,2	50,8	51	57,8	38,5	30
125	1,0	17,7	26,3	35,4	29,2	33,3	45,4	40,5	26,5	35
160	1,0	16,5	24,1	30,6	27,5	29,6	41,7	28,7	18,1	32
180	1,0	17,3	28,5	28,9	25,1	30,7	38,3	22,7	18,3	-
200	1,0	6,5	6,3	21,1	27,1	30,5	35,8	19,4	12,3	29
250	1,0	9,0	10,0	22,0	24,0	28,0	28,0	13,0	9,0	-
315	1,0	12,4	14,0	23,7	21,5	25,7	16,0	6,9	5,9	-

## Pressure loss (straight duct)

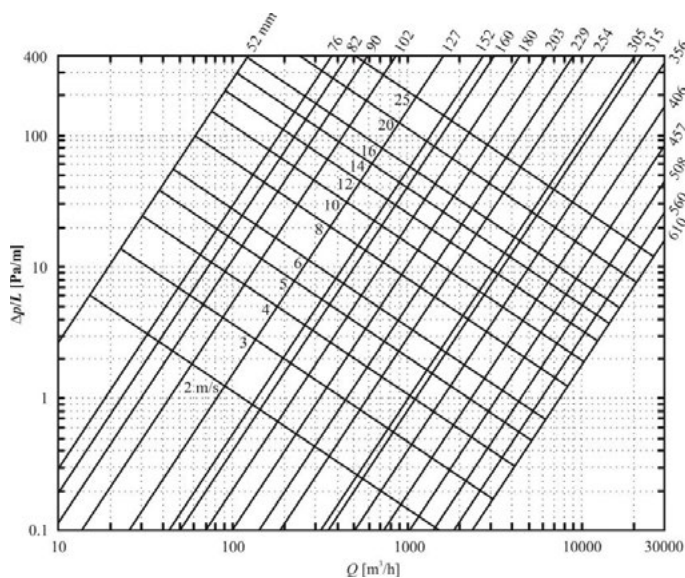

### Insulation properties



### Reach / RoHs Compliant



## Air intake/exhaust KWOV



Made of aluminium



Single-piece casting



Protective mesh



Can be coloured

### Description

Air intake/exhaust vent "KWOV", depending on the purpose, can be used as air intake vent in air supply systems or as air exhaust vent in all types of ventilation. Air intake/exhaust vents are secured on one side by a galvanised wire mesh of 10x10 mm, 1 mm thick. Air intake/exhaust vents are made of cast aluminium.

### Technical drawing

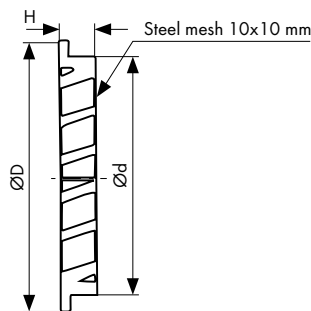

### Dimensions [mm]

Model	ØD	Ød	H
KWOV 100	125	97	20
KWOV 125	150	122	20
KWOV 150	180	147	18
KWOV 160	185	157	18
KWOV 200	225	197	20
KWOV 250	275	247	20
KWOV 315	350	312	20
KWOV 400	440	397	40

### Characteristics

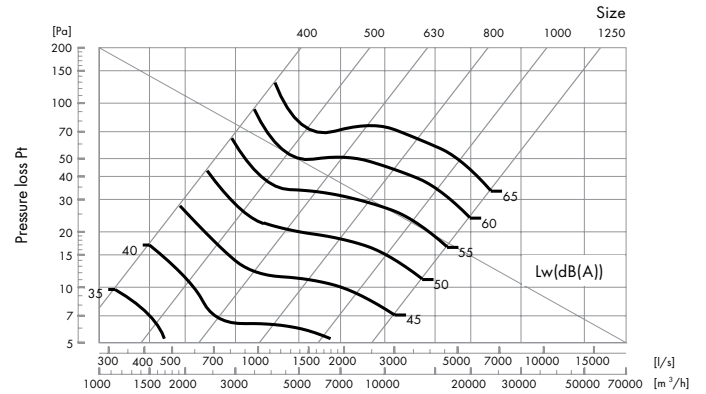
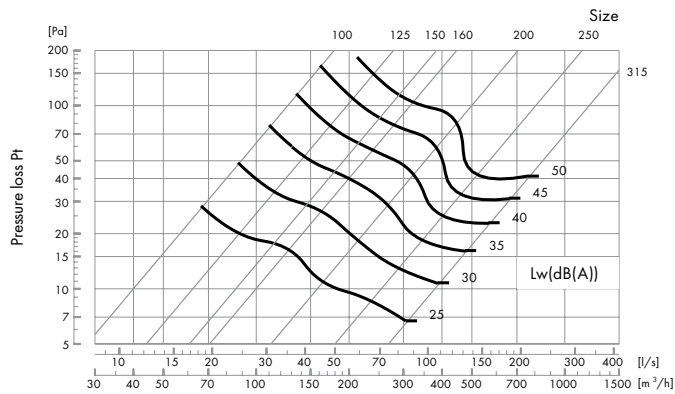

### Efficiency

The chart describes the total pressure Pt [Pa] and sound level LW [dB(A)] as a function of airflow q [l/s, m³/h].



## Air intake/exhaust VLAV



Mounting  
elements in set



Protective mesh  
1x1 mm



Rain hood



Stainless steel  
304

### Description

"VLAV" is used as an air intake/exhaust vent in ventilation systems – recuperation, mechanical and gravity ventilation. Consists of semi-circular cover, which protects from precipitation, and the louvers force directing airflow down. Air exhaust vent "VLAV" has rubber sealing and mounting clamps, which facilitates installation. It is characterised by aesthetic design and high durability. Vents can be used inside or outside the room. "VLAV" is made from brushed stainless steel 304.

### Technical drawing

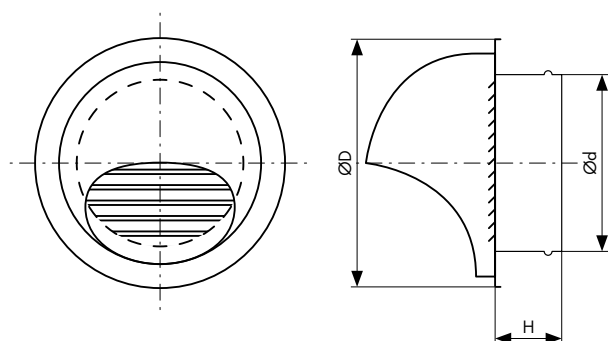

### Dimensions [mm]

Model	Ød	ØD	H
VLAV 100	95	148	48
VLAV 125	120	188	48
VLAV 150	145	210	56
VLAV 160	155	210	61
VLAV 200	195	272	70



## Air intake/exhaust vent VLBV



Mounting  
elements in set



Protective mesh  
9x9 mm



Rain hood



Stainless steel  
304

### Description

"VLBV" is used as an air intake/exhaust vent in ventilation systems – recuperation, mechanical and gravity ventilation. Consists of semi-circular cover, which protects from precipitation. Contains a thick mesh to prevent penetration of insects to the ventilation system. "VLBV" is made from brushed stainless steel 304. Air intake/exhaust vent "VLBV" has rubber sealing and drip cap, which facilitates installation. It is characterised by aesthetic design and high durability. Vents can be used inside or outside the room.

### Technical drawing

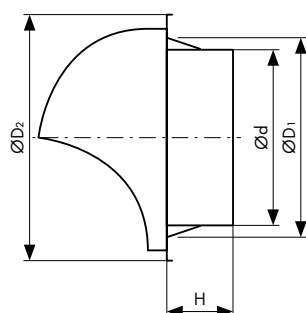

### Dimensions [mm]

Model	Ød	ØD <sub>1</sub>	ØD <sub>2</sub>	H
VLBV 100	97	100	148	48
VLBV 125	120	125	188	48
VLBV 150	145	150	210	56
VLBV 160	155	160	210	61
VLBV 200	195	200	272	70
VLBV 250	245	250	285	70





## Air intake/exhaust ELAV



Mounting  
elements in set



Protective mesh  
4,4 x 4,4 mm



Stainless steel  
304

### Description

Air intake/exhaust vent "ELAV" is made of polished stainless steel 304. Contains a mesh to prevent penetration of insects to the ventilation system. Clamps and rubber sealing facilitate assembly.

### Technical drawing

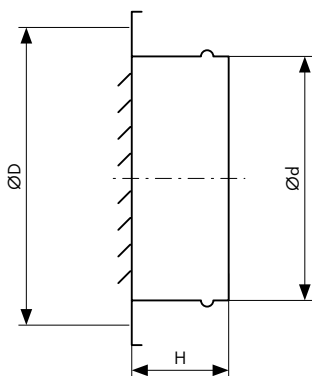

### Dimensions [mm]

Model	Ød	ØD	H
ELAV 100	97	133	52
ELAV 125	120	165	52
ELAV 150	145	192	62
ELAV 160	155	192	62
ELAV 200	195	253	62

## Air intake TRAPEZOIDAL

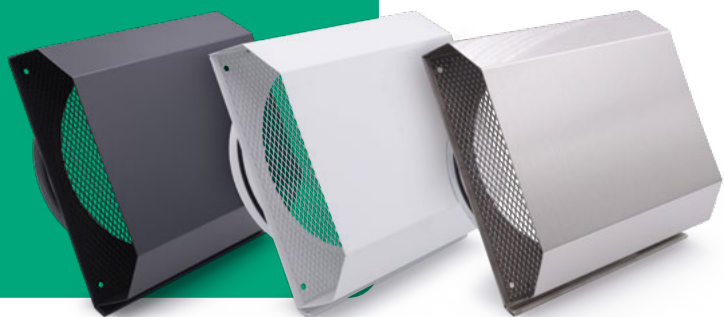

Hood protecting the facade



Protective mesh



Connection duct with a seal



Mounting holes

### Description

Trapezoidal wall mounted air intake HAVACO. The modern-looking air intake aesthetically complements the facade of new buildings. It provides protection against adverse weather conditions and is equipped with a hood to prevent dirt from affecting the facade. The connection duct is fitted with a gasket. Three design options are available: white (RAL 9003), graphite, and polished steel.

### Technical drawing

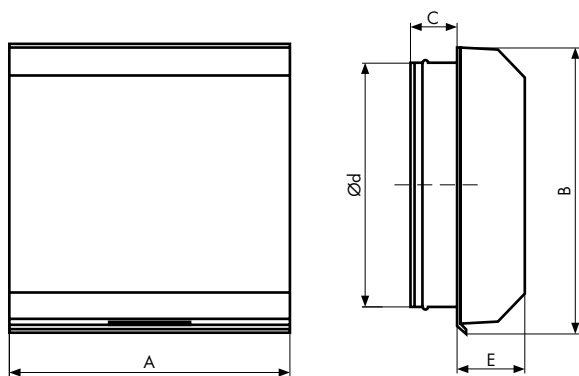

### Dimensions [mm]

Model	A	B	C	Ød	E
Trapezoidal 160	200	214	60	158,5	85,5
Trapezoidal 200	240	254	60	197,9	85,5
Trapezoidal 250	290	304	60	247,8	85,5
Trapezoidal 315	355	368,8	60	312,8	85,5

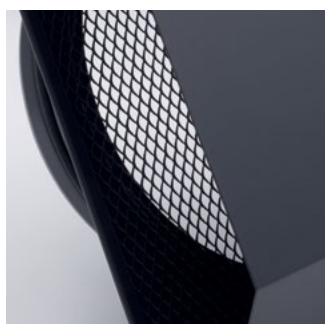

Inlet and outlet protected by mesh

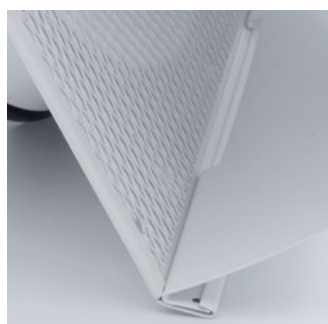

Hood protecting the facade from dirt



Connection duct with a seal



Pre-made mounting holes



## Air outlet

# TRAPEZOIDAL TREND



Hood protecting the facade

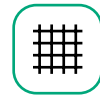

Protective mesh



Connection duct with a seal

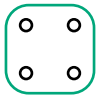

Mounting holes



## Description

Trapezoidal TREND wall mounted air outlet HAVACO. The modern-looking air intake aesthetically complements the facade of new buildings. It provides protection against adverse weather conditions and is equipped with a hood to prevent dirt from affecting the facade. The connection duct is fitted with a gasket. Three design options are available: white (RAL 9003), graphite, and polished steel.

## Technical drawing

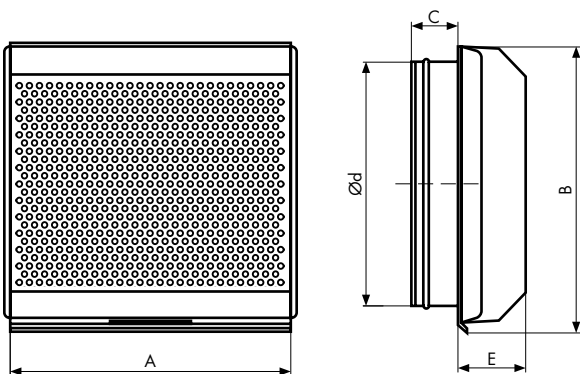

## Dimensions [mm]

Model	A	B	C	Ød	E
Trapezoidal Trend 160	214,6	214	60	158,5	85,5
Trapezoidal Trend 200	254,6	254	60	197,9	85,5
Trapezoidal Trend 250	304,6	304	60	247,8	85,5
Trapezoidal Trend 315	369,6	369	60	312,8	85,5



Inlet and outlet protected by mesh

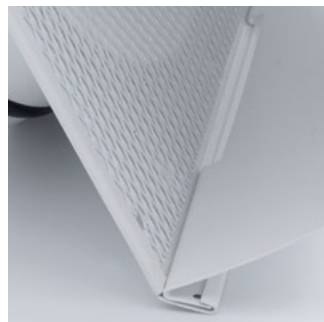

Hood protecting the facade from dirt



Connection duct with a seal



Pre-made mounting holes

## Air intake SOFFIT

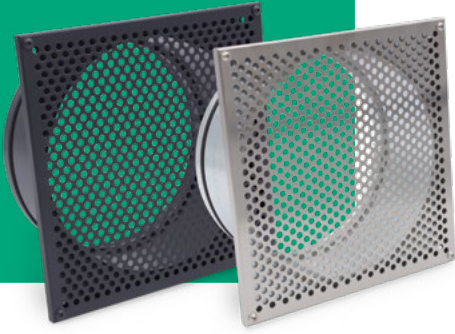

Protective mesh



Connection duct  
with a seal



Mounting holes

### Description

Air intake adapted for installation in the SOFFIT. The SOFFIT is designed to terminate intake channels in mechanical ventilation systems with heat recovery. It provides protection against adverse weather conditions. The connection duct is equipped with a seal. Two design options are available: graphite and polished steel.

### Technical drawing

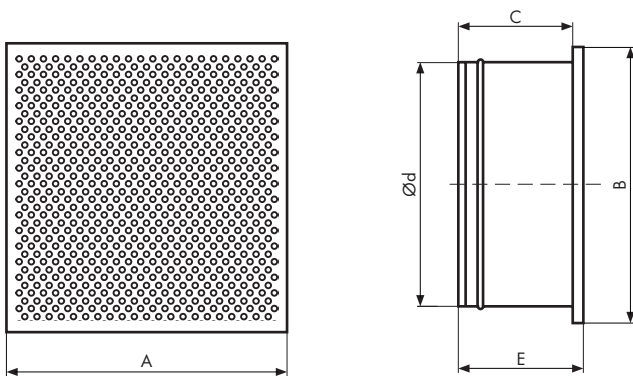

### Dimensions [mm]

Model	A	B	C	Ød	E
SOFFIT 160	197,4	197,4	91	158,4	101,4
SOFFIT 200	227,4	227,4	91	197,85	101,4
SOFFIT 250	277,4	277,4	91	247,3	101,4

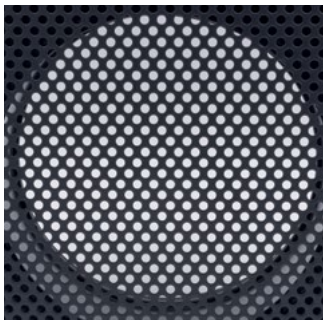

Inlet and outlet protected by mesh



Connection duct with a seal



Pre-made mounting holes

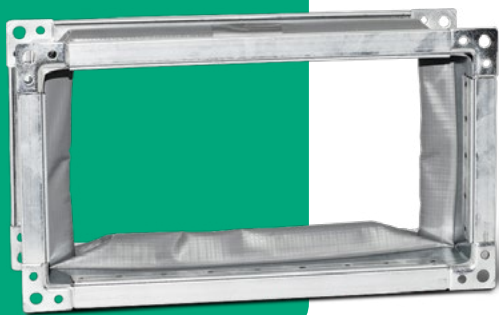

## Anti-vibration connectors for fans with rectangular connection

### REC

#### Description

Connector prevents vibration transport from unit to installation resulting in lower noise level. As standard, the connector is made of galvanised metal sheet. Connectors made of acid-resistant metal sheet and with higher temperature resistance are available on request. A standard flexible connector made from PVC material, with custom options available in Neoprene or Silicone material.

#### Technical drawing

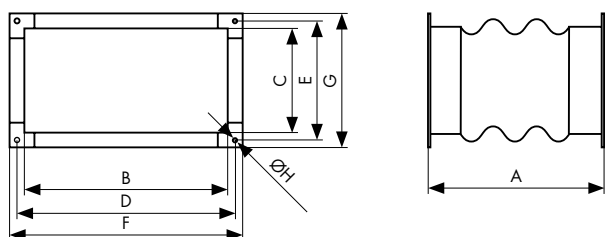

#### Dimensions [mm]

Model	A	B	C	D	E	F	G	ØH
REC-3015	150	300	148	320	170	340	190	9
REC-4020	150	400	198	440	220	440	240	9
REC-5025	150	500	248	520	270	540	290	9
REC-6030	150	600	298	620	320	640	340	9
REC-6035	150	600	348	620	370	640	390	9
REC-7040	150	700	398	720	420	740	440	9
REC-8050	150	800	498	820	520	840	540	9
REC-10050	150	1000	498	1020	520	1040	540	9



## Fastening clamp

### PCC

#### Description

Fastening clamps "PCC" are designed to connect ventilation components, which require removal, without the need to dismantle most of the installation, i.e. fan disassembly. They are also used as additional sealing wire connections. As standard, the interior is covered with polyurethane foam.

#### Technical drawing

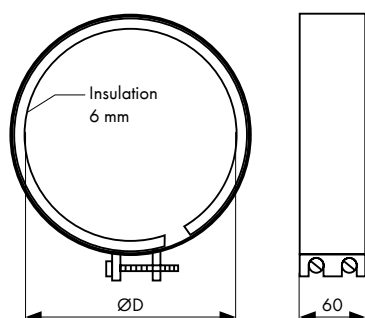

#### Dimensions [mm]

Model	ØD	Model	ØD
PCC 100	100	PCC 315	315
PCC 125	125	PCC 355	355
PCC 160	160	PCC 400	400
PCC 200	200	PCC 450	450
PCC 250	250	PCC 500	500

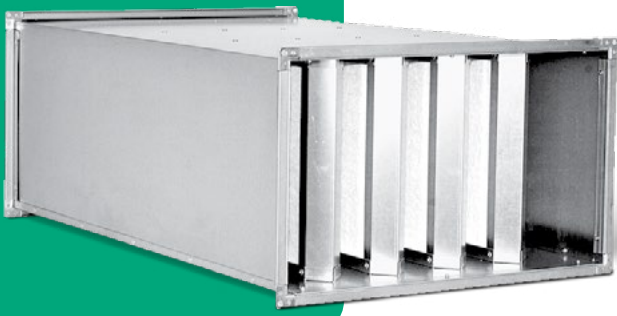

## Rectangular duct silencer RDA

### Description

Ventilation duct silencers effectively reduce noise level in rectangular ventilation ducts. Enclosure is made of welded galvanised metal sheet. Absorbing material applied inside.

### Technical drawing

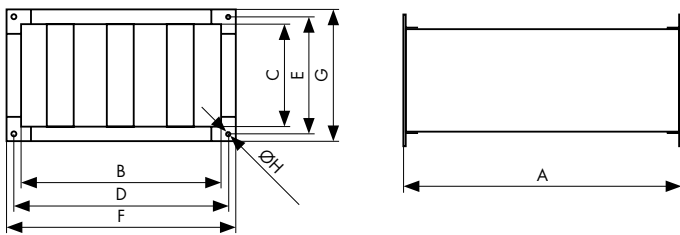

### Dimensions [mm]

Model	A	B	C	D	E	F	G	ØH
RDA-4020	1000	400	198	420	220	440	240	9
RDA-5025	1000	500	248	520	270	540	290	9
RDA-6030	1000	600	298	620	320	640	340	9
RDA-6035	1000	600	348	620	370	640	390	9
RDA-7040	1000	700	398	720	420	740	440	9
RDA-8050	1000	800	498	820	520	840	540	9
RDA-10050	1000	1000	498	1020	520	1040	540	9



# Filter G3 for round ducts FKOV

## Description

Duct filter "FKOV" is applied for air filtration in circular ventilation ducts, with standard diameters of 100-400 mm. The enclosure is composed of a galvanised steel box, closed at the top with snaps. It also consists of mounting connectors with rubber gaskets. Special design of filter "FKOV" enables effortless filter insert exchange. Duct filter "FKOV" comes with filter insert G3 class.

## Technical drawing

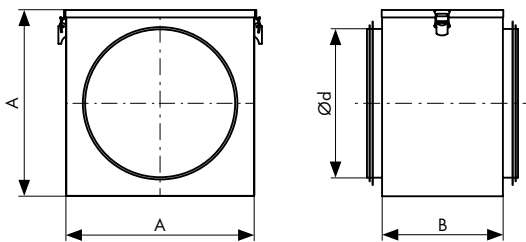

## Dimensions [mm]

Model	Ød	AxA	B
FKOV100	100	160	160
FKOV125	125	180	160
FKOV160	160	210	160
FKOV200	200	250	160
FKOV250	250	300	160
FKOV315	315	360	160
FKOV400	400	470	180

## Characteristics

### FKOV100

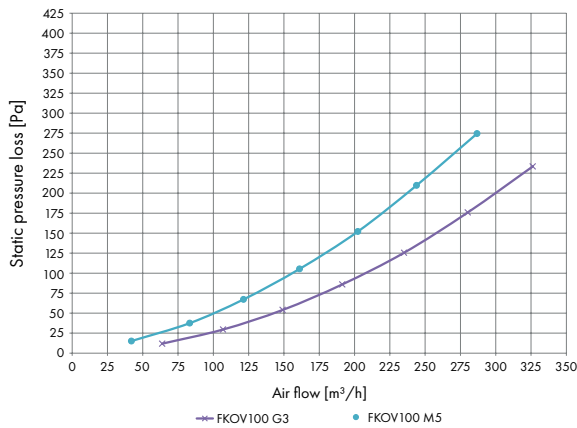

### FKOV125

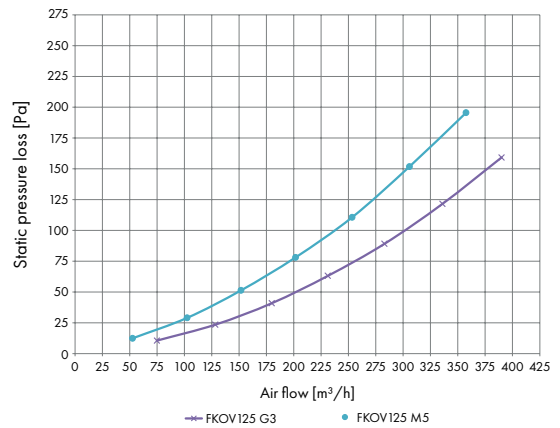

### FKOV160

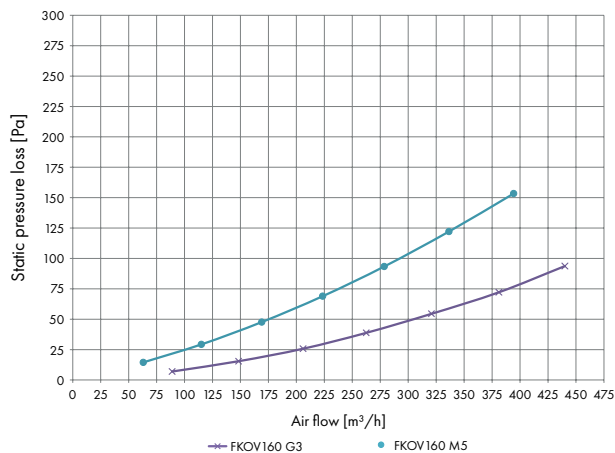

### FKOV200

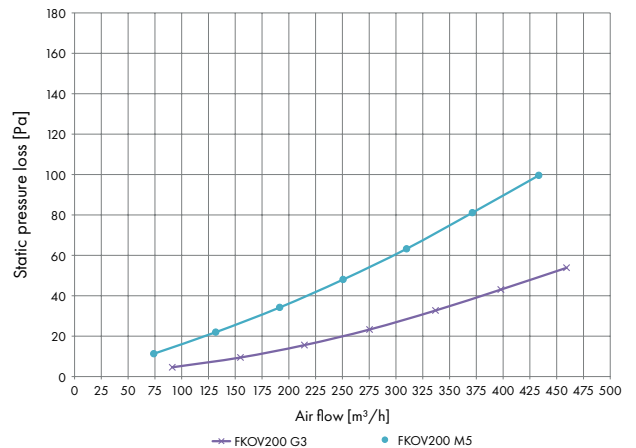

## Characteristics

### FKOV250

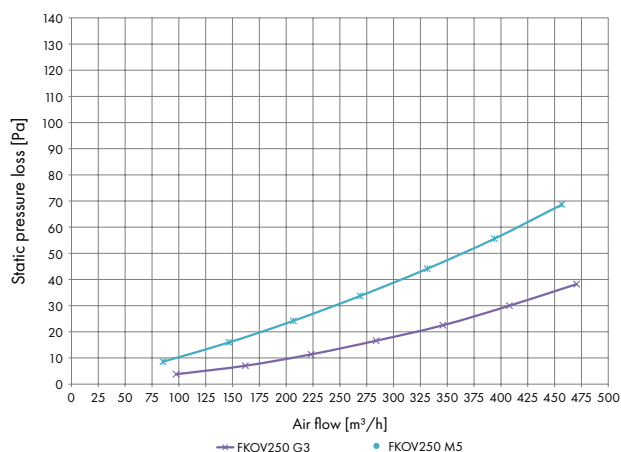

### FKOV315

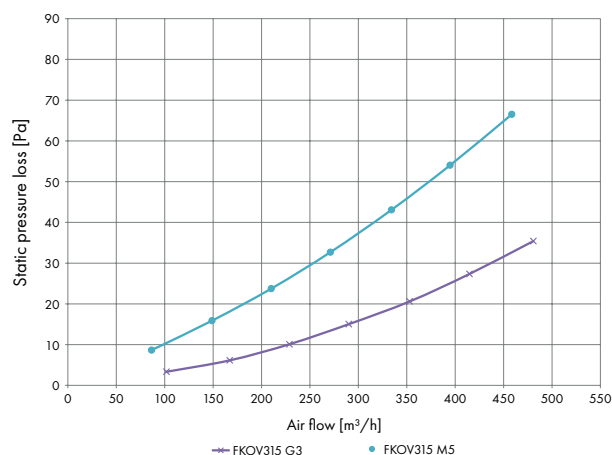

## Access door for rectangular ducts VFAD

### Description

The "VFAD" access door is equipped with a polythene gasket. It is designed for assembly in rectangular ducts. Made of galvanised steel. The set includes a template facilitating hole cutting.

### Technical drawing

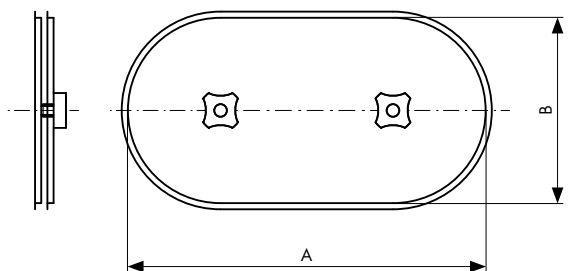

### Dimensions [mm]

Model	A	B
VFAD 180x80	180	80
VFAD 200x100	200	100
VFAD 250x150	250	150
VFAD 300x200	300	200
VFAD 400x200	400	200
VFAD 400x300	400	300
VFAD 500x400	500	400



## Access door for round ducts VCAD

### Description

The "VCAD" access door is designed for assembly in round ducts. The access door is equipped with a gasket which together with special design, ensure a great adhering to a duct surface. As a result, the access door guarantees high airtightness. The set includes a template facilitating hole cutting. Temperature range: -30 °C to +120 °C.

### Technical drawing

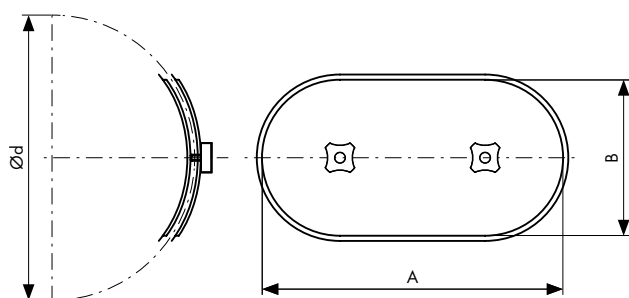

### Dimensions [mm]

Model	Ød	A	B	Weight [kg]
VCAD 125	125	180	80	0,3
VCAD 150-160	150/160	250	150	0,4
VCAD 160	160/180	180	80	0,4
VCAD 180-200	180/200	250	150	0,4
VCAD 200	200	180	80	0,4
VCAD 250	250	250	150	0,4
VCAD 250-280	250/280	200	100	0,4
VCAD 315	315	250	150	0,4
VCAD 400	400	300	200	1,0
VCAD 500	500	300	200	1,0

A and B are the dimensions of the hole that should be cut in the duct.

### Technical specifications

Minimum dimensions of openings in round ventilation ducts, in accordance with PN-EN 12097 standard.

Rectangular or oval hole

Minimum duct diameter (mm) D	Minimum dimensions of openings in duct walls (mm) AxB
$100 \leq D < 200$	180x80
$200 \leq D < 315$	200x100
$315 \leq D < 500$	300x200
$500 < D$	500x300

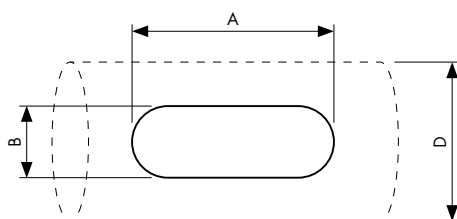

### Test of the tightness of round ducts with diameters ranging from 80 mm to 1600 mm

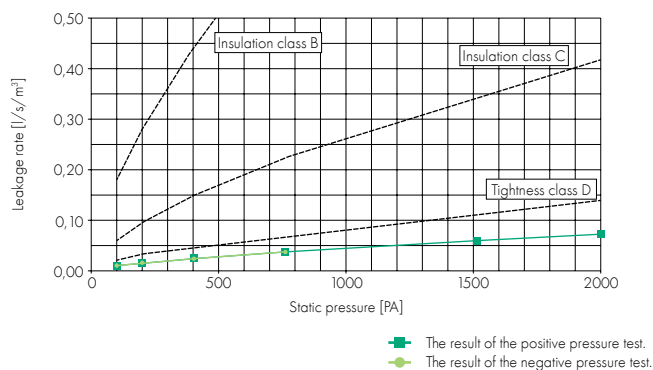

# Mounting bracket with gasket CRDG



## Description

The "CRDG" clamp consists of two components connected by steel bolts. Up to and including a diameter of 450 mm, only one side is self-clamping, thereby clamp assembly on ventilation ducts is facilitated. In this diameter range fastening clamp is mounted to threaded rod or to double-threaded bolt through rivet nuts M8/M10. For reasons of assembly safety, clamps with diameters from 500 mm should be mounted through two threaded rods. Fastening clamps "CRDG" are, as a standard, equipped with a rubber gasket EPDM with the option of removal.

## Technical drawing

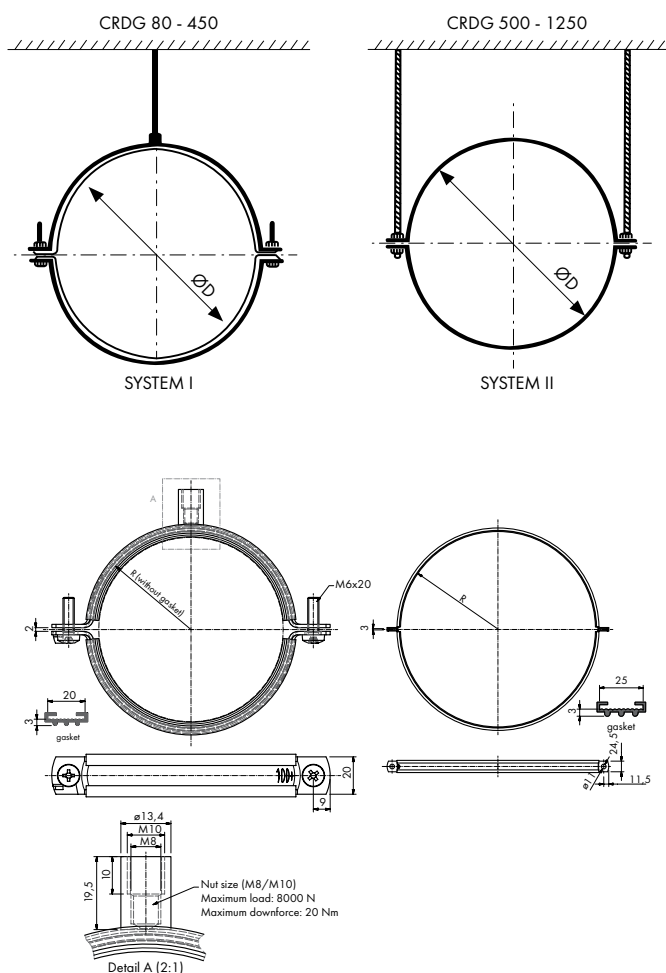

## Dimensions [mm]

Model	ØD	System
CRDG 80	80	I
CRDG 100	100	I
CRDG 125	125	I
CRDG 150	150	I
CRDG 160	160	I
CRDG 200	200	I
CRDG 250	250	I
CRDG 315	315	I
CRDG 400	400	I
CRDG 450	450	I
CRDG 500	500	II
CRDG 560	560	II
CRDG 630	630	II
CRDG 710	710	II
CRDG 800	800	II
CRDG 900	900	II
CRDG 1000	1000	II
CRDG 1250	1250	II





## Flexible connector HCV

### Description

Flexible connector for production of flexible connectors. Made of galvanised steel tape, permanently combined with anti-vibration plastic material. Helps prevent vibration and noise transmission in ventilation systems. Temperatures range from -30°C to 80°C.

### Technical drawing

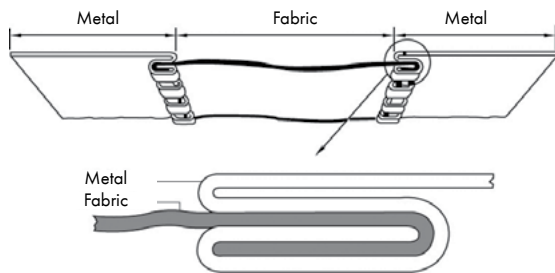

### Dimensions [mm]

Model	Metal	Material	Metal
HCV 30/60/30	30	60	30
HCV 35/60/35	35	60	35
HCV 45/75/45	45	75	45

### Technical specifications

Basic fabric	Polyester YARN
Coating	PVC
Color	Grey
Range of application temperature	-30/+80°C
Length	25 mb



## Rubber mat MKV PRO

### Description

Self-adhesive rubber mats "MKV" are made of rubber foam, mesh enforced. Intended for thermal insulation of plenum boxes, distributors, and for ventilation and conditioning systems. Roll width 1 m.

### Technical drawing

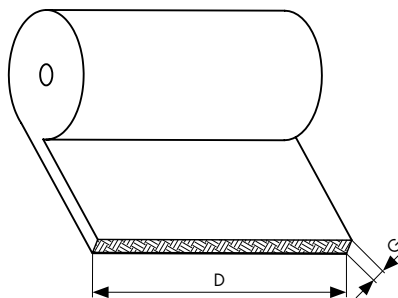

### Dimensions [mm]

Model	D	G	Roll [m <sup>2</sup> ]
MKV PRO 6/30	1000	6	30
MKV PRO 10/20	1000	10	20
MKV PRO 19/10	1000	19	10

### Technical specifications

Thermal conductivity [W/(m <sup>2</sup> K)]	$\lambda$ 0°C ≤ 0,037; $\lambda$ 40°C ≤ 0,040
Temperature range	-40°C ÷ +85°C
Water vapor permeability	7000μ
Regulation	CE EN 14304:2009+A1:2013
Thickness	6 mm, 10 mm, 19 mm
Water vapor permeability	WS01

## Roof foot FLEXO FOOT



### Description

The rooftop support **"FLEXO FOOT"** is dedicated for weight support of any kind of heating, air conditioning-ventilation units, ventilation and exhaustive ducts, and other rooftop and indoor units or elements.

While designing the product, particular emphasis has been placed on achieving a stable structure. While maintaining the aesthetic appearance, roof support **"FLEXO FOOT"** is characterised by its functionality and ease of assembly. Round shape, and colour form a consistent monolith with the roof slope.

### The kit includes:

- 2 supports made of PA6 GF 30 with an external diameter of 340 mm
- 2 anti-slip mats made of SBR material (obtained in the recycling process)
- 2 90 degree angle bars with connecting elements
- 2 slip nuts with spring, which greatly facilitate the process of mounting the angle in the profile 41x41 mm

### Additional option:

2 elements of smooth angle adjustment up to 7 degrees. Maximum load on the support is 300 kg.

### Possible configurations

**"FLEXO FOOT"** roof supports can be freely configured in order to minimise unit pressure. Below shows examples of combined systems and results achieved at maximum load equal to 400 kg.

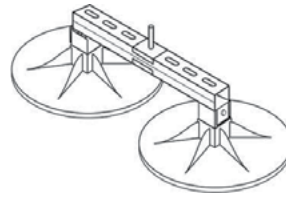

2 supports  
pressure 0,189 kg/cm<sup>2</sup>

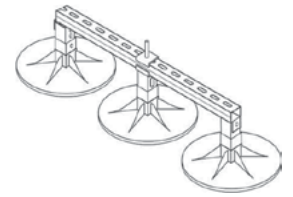

3 supports  
pressure 0,119 kg/cm<sup>2</sup>

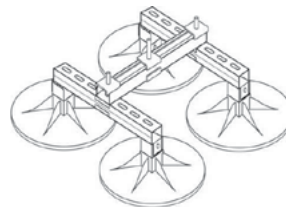

4 supports  
pressure 0,090 kg/cm<sup>2</sup>

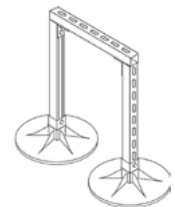

2 supports (gate)  
pressure 0,188 kg/cm<sup>2</sup>

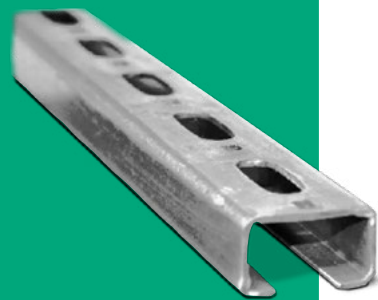

## Mounting profile STU

### Description

The **"STU"** mounting profile is used to suspend ventilation ducts and to build supporting structures for ventilation and air conditioning units. **"STU"** profiles are a solid basis for every newly designed and performed installation from HVAC, sanitary and heating barracks, and electrics.

### Technical drawing

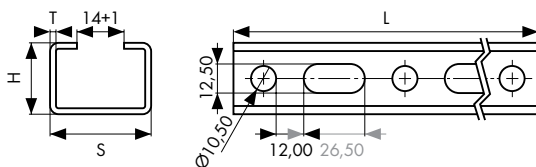

### Dimensions [mm]

Model	S	H	T	L
STU 30x20x1,5/3	30	20	1,5	3000
STU 30x30x1,8/3	30	30	1,8	3000
STU 30x30x1,8/5	30	30	1,8	5000
STU 30x30x1,8/6	30	30	1,8	6000
STU 41x41x2,0/3	41	41	2,0	3000
STU 41x41x2,0/6	41	41	2,0	6000



## End cap for mounting profile **Z-STU**

The cap is used at the end of the "STU" mounting profiles. Improves the appearance of the ventilation system and protects the sharp ends of the profile.

**Dimensions [mm]: 30x20, 30x30, 41x41**

## Galvanised steel nut **NN**



Hexagon steel nut, galvanised.

### Dimensions [mm]

Model	Diameter	Weight
M8	8	10 kg
M10	10	10 kg



## Shock absorber/gasket for mounting profile **GA**

The shock absorber "GA" is used for mounting profiles "STU" as a protection against the vibrations transmission between the profile and the ventilation duct. Designed for profiles:  
GA30 for STU profile 30 mm  
GA41 for STU profile 41 mm.



## Galvanised, enlarged round washer **WWW**



Round, galvanised, enlarged round washer.

### Dimensions [mm]

Model	Diameter	Weight
M8	8	10 kg
M10	10	10 kg

## Galvanised washer **WW**



Round, galvanised washer.

### Dimensions [mm]

Model	Diameter	Weight
M8	8	10 kg
M10	10	10 kg



## Galvanised bolt **BB**

Hexagon head screw, galvanised, metric thread over the entire length of the mandrel.

### Dimensions [mm]

Model	Diameter	Length	Weight
M8 x 25	8	25	10 kg
M8 x 50	8	50	10 kg
M8 x 60	8	60	10 kg
M10 x 25	10	25	10 kg
M10 x 40	10	40	10 kg

## Two-thread bolt **VDF**



Two-thread bolt, for mounting brackets in walls and ceilings; galvanised steel.

### Dimensions [mm]

Model	Diameter	Length	Packaging
M8 x 120	8	120	100 pcs.
M10 x 100	10	100	100 pcs.

## Dowel



For non-structural multi-point fastening of statically loaded building elements in substrates made of: concrete, solid brick, ceramic blocks, in combination with screws.

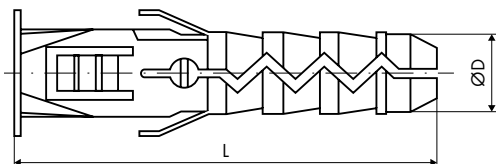

### Dimensions [mm]

Model	ØD	L
12 x 60	12	60
14 x 70	14	70

## Mounting console with bracket TKO



Mounting console with its support, for use in high-strength support structures, galvanised steel, welded construction.

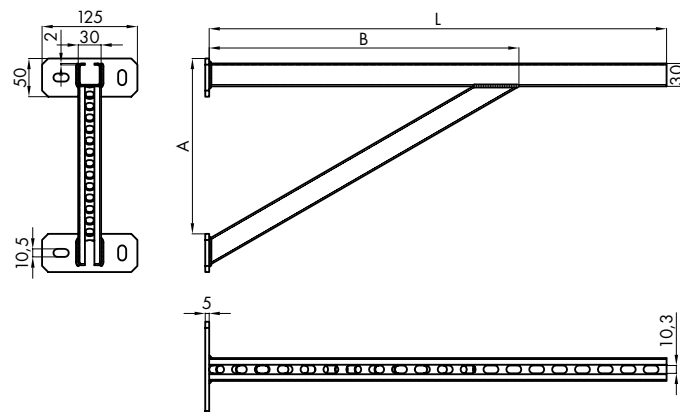

### Dimensions [mm]

Model	L	A	B	Supporting profile [type]
TKO 500	500	230	400	FT30
TKO 600	600	230	400	FT30

## Console T



Mounting console for use in support structures, galvanised steel, welded construction.

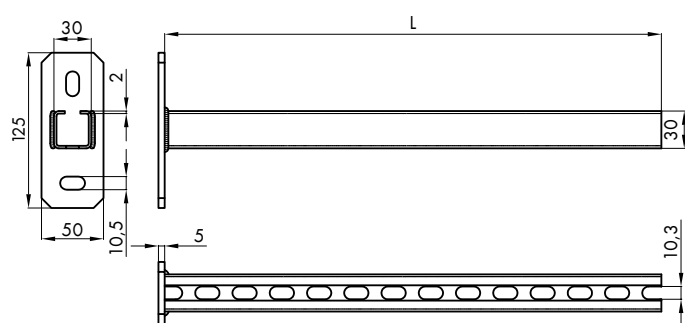

### Dimensions [mm]

Model	L	Supporting profile [type]
T 300	300	FT30
T 500	500	FT30
T 750	750	FT30

## Cantilever arm FT



The support of mounting profile base, used in the formatting of supporting structures, galvanised steel, welded construction.

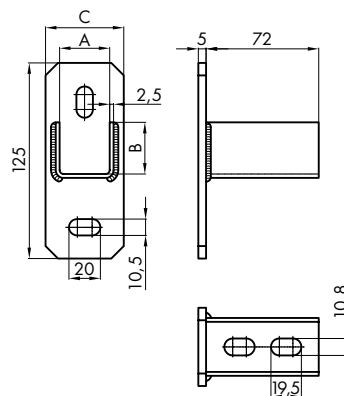

### Dimensions [mm]

Model	A	B	C	Supporting profile [type]
FT 30	32	31	50	FT30
FT 40	43	42	60	FT40



## Threaded rods PGI

The rods are made of galvanized steel, length 2 m.

**Dimensions: M8, M10**

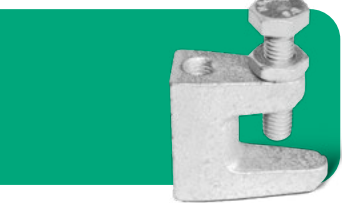

## Beam clamp for threaded rod HBV

The brackets are made of galvanized steel.

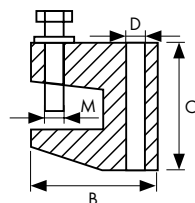

### Dimensions [mm]

Model	B	C	D	M	Max load [kg]
M8	38	35	M8	10	112
M10	45	42	M10	10	245

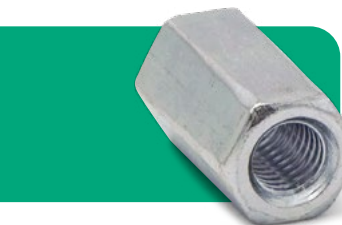

## Coupling nut NBV

Coupling nut, galvanized steel, allows connecting threaded rods.

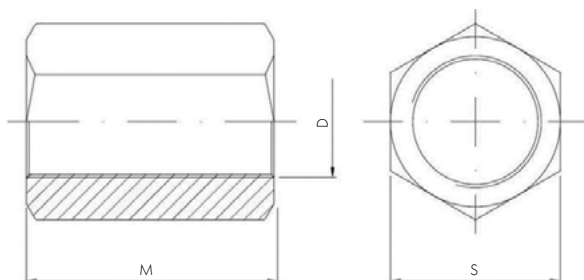

### Dimensions [mm]

Model	D	M	S	Box [pcs]
M8	M8	24	13	100
M10	M10	30	17	100



## Drop-in anchor TKV

Steel or brass drop-in anchors enable the assembly, among others, of threaded rods in ceilings and walls.

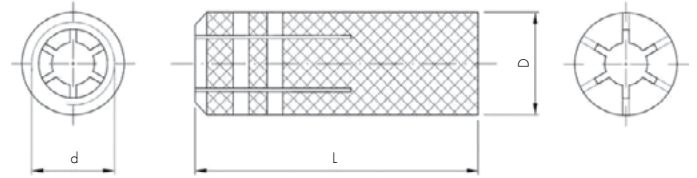

### Dimensions [mm]

Model	d	L	D	Box [pcs]
M8	M8	28	10	100
M10	M10	33	12	50

## Duct band clamp and clamps CFB, CFC



Clips for connecting flexible cables to fittings, adapters, etc. "CFC" clamps are required for the straps.

### The CFB band

Length - 30m  
Width - 9mm  
Material - stainless steel

### CFC clamps

Quantity of clamps in the package: 50 pieces.

## Nylon band CFN

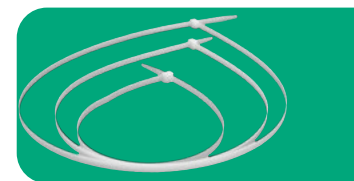

The "CFN" nylon band clamps are a very good alternative to metal bands. Their design ensures quick and easy installation. "CFN" bands can be used in temperatures from -55°C to +100°C. Box of 100.

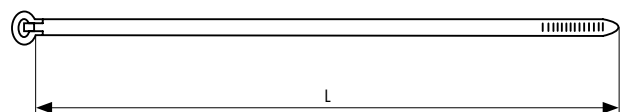

### Dimensions [mm]

Model	L	Max diameter	Model	L	Max diameter
CFN 200	200	-	CFN 920	920	290
CFN 550	550	175	CFN 1188	1188	378
CFN 800	800	255	-	-	-



## Steel band CFS

"CFS" steel strap clamps for flexible ducts. Box of 100.

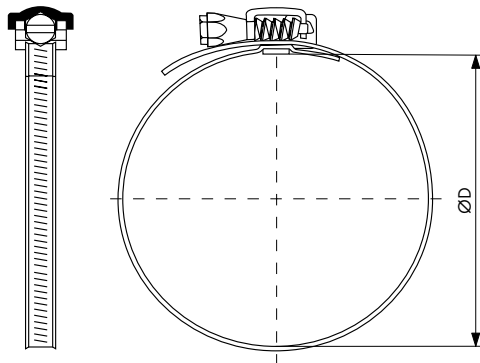

### Dimensions [mm]

Model	Diameter range [mm]	Model	Diameter range [mm]
CFS-110	60 - 110	CFS-270	60 - 270
CFS-135	60 - 135	CFS-320	60 - 320
CFS-165	60 - 165	CFS-525	60 - 525

## Flange profile corner NV



Ventilation flange profile corners are made of galvanised steel, for rectangular ducts assembly.

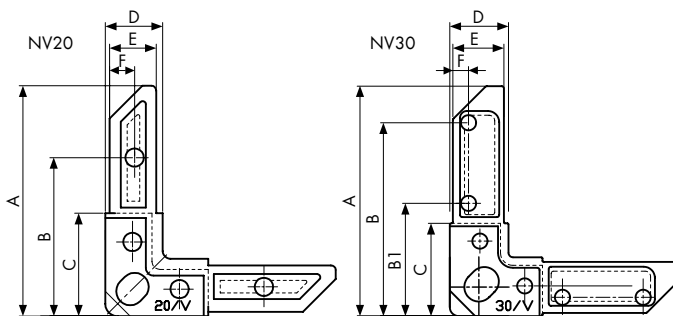

### Dimensions [mm]

Model	A	B	B1	C	D	E	F
NV20	73,8	50,8	-	33	18,4	14,9	8
NV30	102,9	86,5	50,4	41,5	26,3	22,9	7



## Perforated band DPH

Perforated tape to suspend ventilation ducts, made of galvanized steel.

### Dimensions [mm]

Width	Thickness	Length [m]
17	0,6	25
25	0,6	25

## G-Clamp GCV



Ventilation galvanized steel g-clamps GCV allows a secure connection of rectangular duct edges.

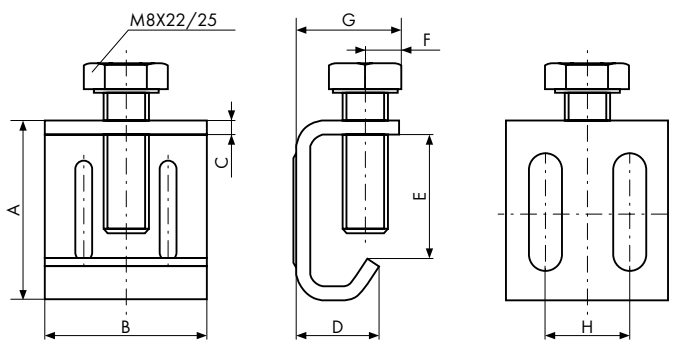

### Dimensions [mm]

Model	A	B	C	D	E	F	G	H
GCV 2,5	32	28,6	2,5	15±0,5	22	6	18,3	15
GCV 3,0	32,5	29	3	15,2±0,5	21,8	7	19,5	15,5



## Flange profile PK

Rectangular duct flange, galvanised. Enhances duct or fitting flange. Enables flanged assembly by "GCV" clamps or through slide-in profile.

### Dimensions [mm]

Model	Height	Length
PK20	20	2500
PK20	20	5000
PK30	30	5000



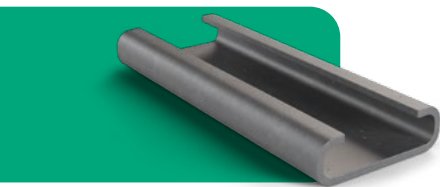

## Slide-in profile PWQ

The "PWQ" slide-in profile is used to connect rectangular channels together. The specified length of the profile is applied to the connected frame profiles "PK20" or "PK30". Most often used when it is necessary to fully connect the channels along their entire frame length, and in hard-to-reach places where there is no space over the channel to put your hand in order to twist the "GCV" duct clamps.

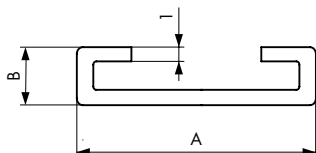

### Dimensions [mm]

Model	A	B	Length
PWQ20	20	6	5000
PWQ30	30	6	5000

## Mounting brackets Z, L, V



Mounting brackets for rectangular and circular ducts. Sheet thickness 2 mm.

### Type: L

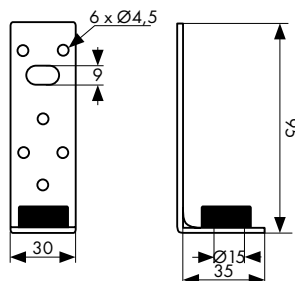

### Type: Z

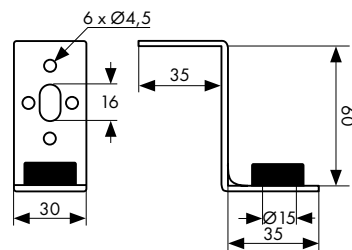

### Type: V

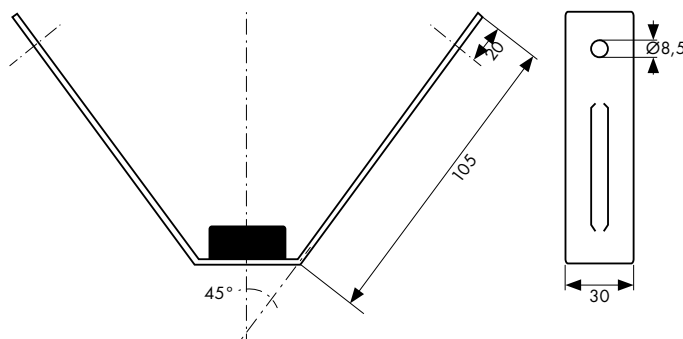

## Gasket PES

The "PES" gasket is used to seal the connections of rectangular ventilation ducts, polyurethane foam, dark grey colour.

### Dimensions [mm]

Model	Width	Thickness	Packaging [m]
PES 10.4	10	4	100
PES 14.4	15	4	60
PES 10.7	10	7	50
PES 15.7	15	7	30

## Discs for steel cut TCS



The discs are designed for quick cutting of structural steel, sheet metal, pipes and flanges.

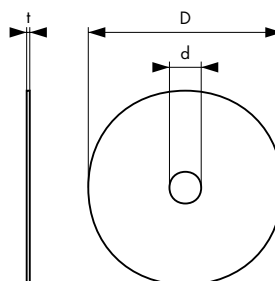

### Dimensions [mm]

Model	D	d	t	Box
TCS 115	115	22,23	1,2	25 pcs.
TCS 125	125	22,23	1	25 pcs.



## Self-drilling screws SSD-C

Zinc-plated self-drilling screws. Cross head end.

### Dimensions [mm]

Model	Diameter	Length	Box
SSD-C 4,2/13	4,2	13	1000 pcs.
SSD-C 4,2/16	4,2	16	1000 pcs.

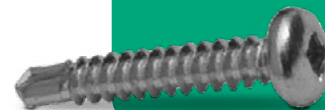

## Self-drilling screws SSD-IM

Zinc-plated self-drilling screws. Head end imbus type. A key is included.

### Dimensions [mm]

Model	Diameter	Length	Box
SSD-IM 4,2/13	4,2	13	1000 pcs.
SSD-IM 4,2/16	4,2	16	1000 pcs.



## Screws tip SSD

Magnetic cap for mounting screws. Hexagon head end "SSD-H".

### Dimensions [mm]

Model	Imbus	Box
Hexagon 7 mm	4,2	1 pcs.
Hexagon 8 mm	4,2	1 pcs.



## Self-drilling screws SSD-H

Zinc-plated self-drilling screws. Hexagon head end 7 mm.

### Dimensions [mm]

Model	Diameter	Length	Box
SSD-H 4,2/13	4,2	13	1000 pcs.
SSD-H 4,2/16	4,2	16	1000 pcs.



# Reinforced aluminium tape

## ATSE



Mechanically resistant to tensile



Wide range temperature



High-quality aluminium foil

### Description

Reinforced aluminium tape is a combination of premium grade aluminum foil and scrim coated with a high performance synthetic rubber adhesive and protected by an easy release silicone release paper for specialized HVAC insulation applications. Storage should be under normal room temperature in the original packing.

### Technical specifications

Properties	Unit	Specification	Test method
Peel strength	N/25 mm	≥ 14,7	ASTM - D3330
Tensile strength	MPa	≥ 15,5	ASTM - D3759
Elongation at break	%	≥ 2.5	ASTM - D3759
Roll ball tack	mm	≤ 120	ASTM - D3121
Temperature range	[°C]	-35°C ~ +55°C	-
Application temperature	[°C]	15°C ~ 35°C	-

### Features

- Foil Scrim backing provides a strong reinforcement and an excellent reflection of both heat and light
- The strong adhesive offers long service life in indoor as well as high humid atmosphere
- Low moisture vapor transmission rate makes excellent vapor barrier
- It has good resistance to abrasion and aging

### Dimensions

- Standard width: 50 mm, 70 mm, 100 mm
- Standard length: 45 m

### Applications

- For the installation and sealing of duct insulation made of mineral and glass wool, rubber and polyethylene
- For sealing flexible insulation ducts
- For installation of prefabricated duct insulation
- For mounting a sound insulation



Aluminium foil tape is a combination of premium grade aluminum foil and scrim coated

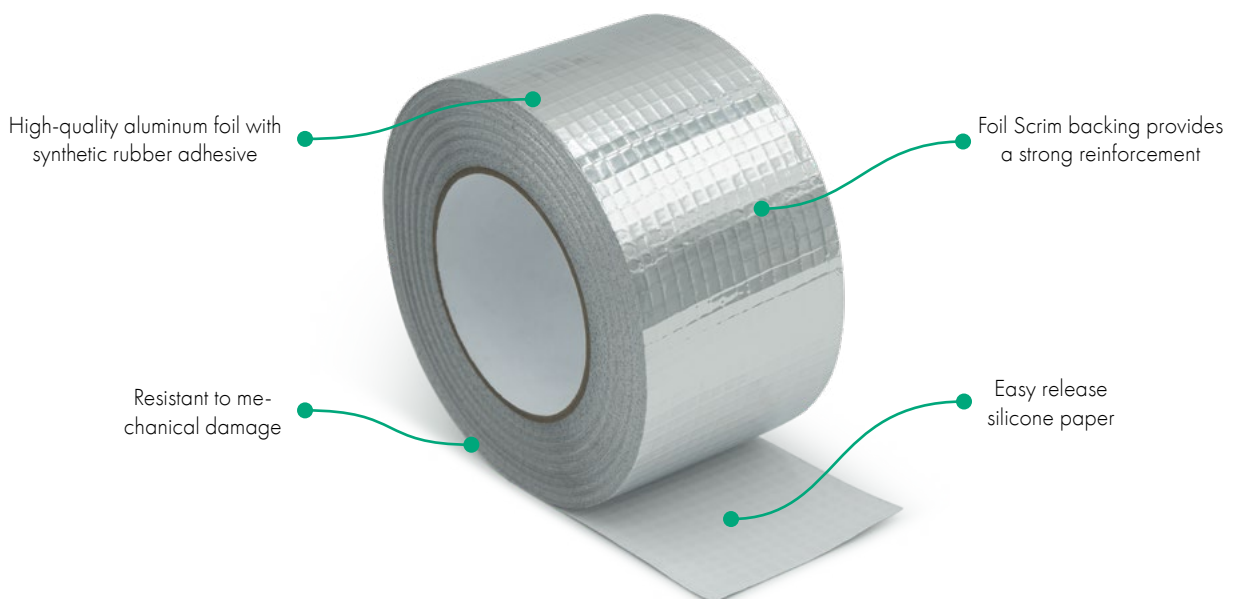

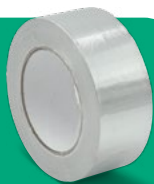

## Aluminium tape ATSS

Adhesive tape aluminium, acrylic adhesive, used for installation of mineral wool insulation.

### Technical specifications

Width x length [mm x m]	Temperature [°C]	Box [pcs.]
50 x 45	-35/120	24
75 x 45	-35/120	16
100 x 45	-35/120	12



## White textile tape TTB

Textile adhesive tape, reinforced with fabric mesh, white colour, rubber adhesive, waterproof, high initial bonding strength, for insulation of copper pipe connections in insulation, among others.

### Technical specifications

Width x length [mm x m]	Temperature [°C]	Box [pcs.]
48 x 50	-10/75	24



## Metallized tape ATPP

Polypropylene adhesive tape, metallized aluminium layer, acrylic adhesive, for insulation of ventilation duct connections, among others.

### Dane techniczne

Width x length [mm x m]	Temperature [°C]	Box [pcs.]
50 x 50	-10/70	96
75 x 50	-10/70	64



## Black textile tape TTC

Textile adhesive tape "TTC", reinforced with fabric mesh, black colour. Rubber adhesive. Waterproof. High initial bonding force. Used, among others, for insulation of copper pipe connections in insulation. Resistant to temperatures from 0°C to +60°C.

### Technical specifications

Width x length [mm x m]	Temperature [°C]	Box [pcs.]
50 x 45	-10/75	24

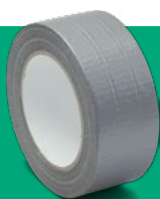

## Grey textile tape TTS

Textile adhesive tape "Duct Tape", reinforced with fabric mesh, grey colour, rubber adhesive, waterproof, high strength of initial bonding, for insulation of ventilation connections, among others.

### Technical specifications

Width x length [mm x m]	Temperature [°C]	Box [pcs.]
48 x 50	-10/75	24



## Mounting tape PVC PVCT

Mounting self-adhesive tape PVC, flexible, grey colour, rubber adhesive, resistant to temperature +80°C, for insulation of ventilation connections, among others.

### Technical specifications

Width x length [mm x m]	Temperature [°C]	Box [pcs.]
50 x 33	0/80	45



## Zinc spray for ventilation ducts

Zinc spray designed for (cold electroplating.) Protects all metal surfaces from corrosion. Creates an even layer that can be painted or left as final protection. Ideal for retouching, finishing or repairing galvanised elements. Used on metal surfaces: iron, aluminium, steel.

### Technical specifications

Box	12 pcs.
Volume	400 ml
Pressure in 20°C	5,5 bar
Color	Light grey/aluminium
Capacity	2 - 3 m <sup>2</sup>
Drying time in 20°C	Surface: 10 minutes Touch-dry: 20 minutes For use: 6 hrs Applying successive coatings after 12 hrs



## Soudal Acryrub grey acryl

An acrylic dispersion-based sealant with excellent adhesion to all porous substrates used in construction: brick, concrete, wood, stone, plasterboard, etc. It does not contain solvents and is odorless. After drying, it can be painted and varnished. Suitable for both indoor and outdoor use.

### Technical specifications

Base	Acrylic dispersion
Volume	310 ml
Consistency	Paste
Curing system	Physical drying
Drying time	Approx. 20 minutes (at 20°C / 65% RH)
Density	1,7 g/cm <sup>3</sup> (depending on the color)
Application temperature	From +5°C to +30°C
Thermal resistance	From -20°C to +80°C
Maximum allowable deformation	Approx. 15%
Shrinkage after curing	Approx. 15%
Color	Grey
Resistance to sagging	≤ 3 mm
Volume loss	≤ 25%
Elastic recovery	< 40%
Standards and certifications	ISO 9001 SCAQMD Reg. 1168 USGBC LEED® 2009 v.4.1 (VOC)

## Grey silicone TIGER



For sealing and filling the openings around the ventilation ducts.

### Technical specifications

Model	Thermal resistance	Volume	Box
Grey silicone TIGER	-50°C to +120°C	260 ml	24 pcs.

## Mounting foam TIGER



For filling cracks and gaps in connections.

### Technical specifications

Model	Volume	Box
Mounting foam FOAM 750 (tube)	750 ml	12 pcs.
Mounting foam GUN FOAM 750 (gun)	750 ml	12 pcs.

# Flexo System

Flexible ducts • Distribution boxes • Plenum boxes • Accessories

Complete air distribution solution, dedicated to work with KOMFOVENT heat recovery units. The **Flexo System** includes flexible plastic ventilation ducts, expansion boxes, distributors, bypasses, dampers, connectors and other accessories.

The integrated **HAVACO Flexo System** enables faster and easier installation of ventilation/heat recovery systems, particularly in homes. This saves time and costs, as well as reduces the dimensions of the ducts in comparison to traditional ventilation systems.

## Why it's worth using FLEXO SYSTEM:

- ☑ Simple to design and execute.
- ☑ Installation without the use of specialised tools.
- ☑ High mechanical strength.
- ☑ Excellent thermal and acoustic properties.
- ☑ High-quality rubber seals.
- ☑ Low height enabling embedding in the ceiling or hiding in the wall.
- ☑ Low installation resistance - small bending radius, smooth surface.
- ☑ Ducts with anti-static, anti-bacterial, and anti-fungal properties.
- ☑ A wide range of fittings ensures easy execution of any installation.

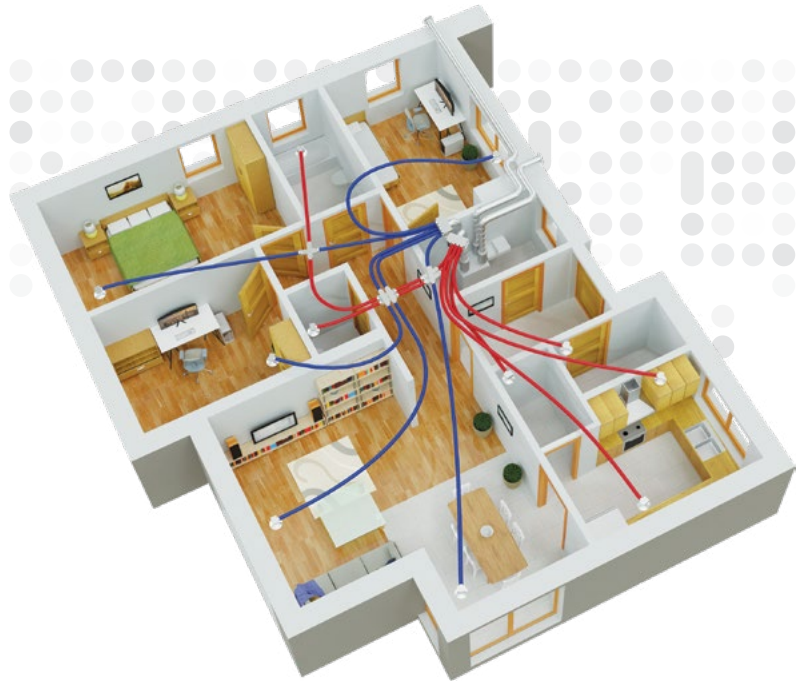

## The recommendations for the amount of air flowing through FLEXO SYSTEM components



### FLEXO DUCT SPECTRA 1000

Ventilation duct  
Ø75 mm ~30 m<sup>3</sup>/h  
Ø90 mm ~45 m<sup>3</sup>/h



### FLEXO BOX PRO T1

Plenum box  
Ø125 mm / 1x Ø75 mm  
~30 m<sup>3</sup>/h



### FLEXO BOX PRO K

Angle insulated distribution box  
Ø160 mm / 8x Ø75 mm  
8x 30 m<sup>3</sup>/h = ~240 m<sup>3</sup>/h

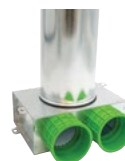

### FLEXO BOX PRO T2

Plenum box  
Ø125 mm / 2x Ø75 mm  
2x 30 m<sup>3</sup>/h = ~60 m<sup>3</sup>/h



### FLEXO BOX PRO P

Insulated distribution box  
Ø160 mm / 8x Ø75 mm  
8x 30 m<sup>3</sup>/h = ~240 m<sup>3</sup>/h

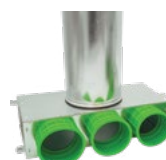

### FLEXO BOX PRO T3

Plenum box  
Ø125 mm / 3x Ø75 mm  
3x 30 m<sup>3</sup>/h = ~90 m<sup>3</sup>/h

# Get to know HAVACO Flexo System in detail

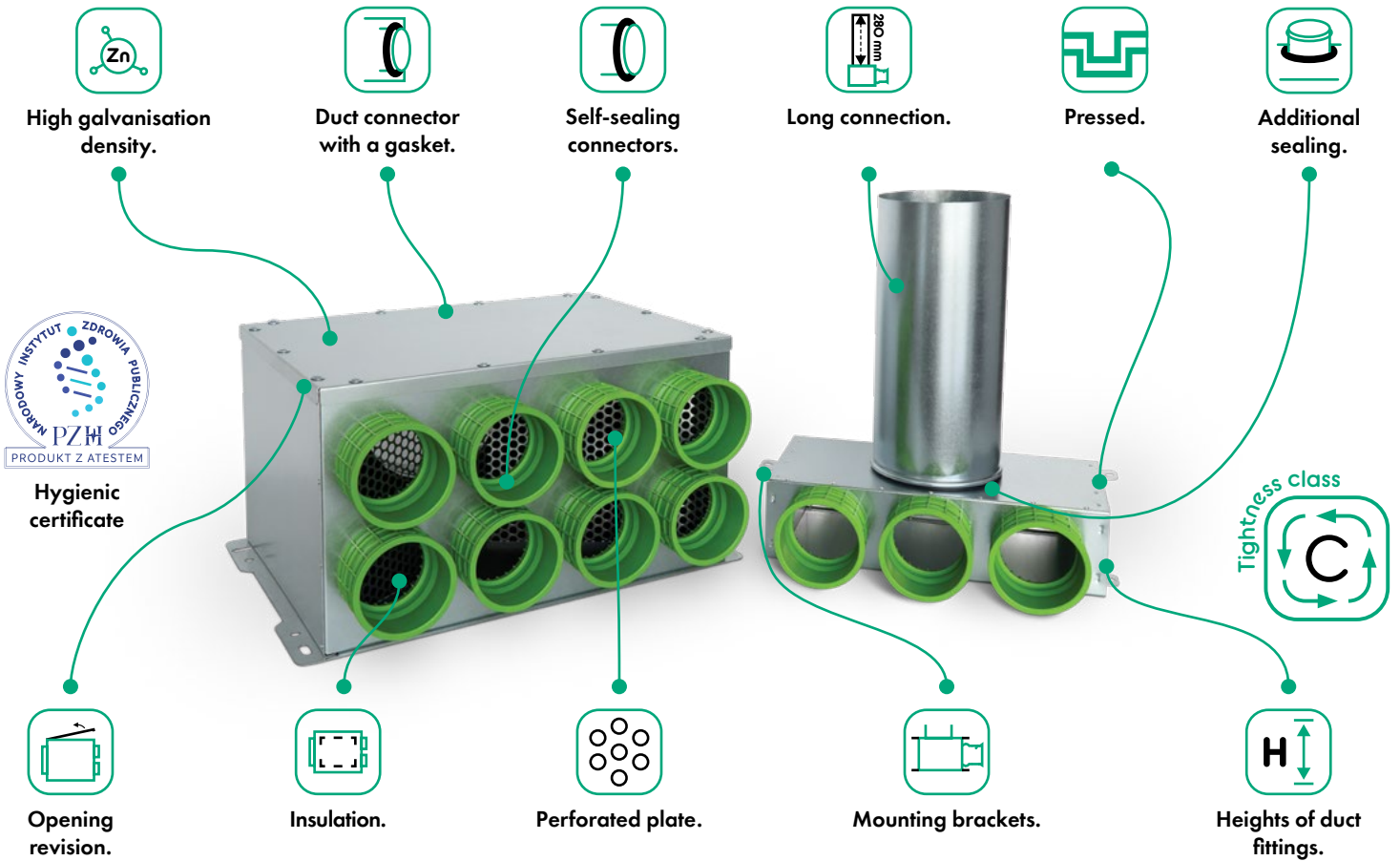

**Perforated plate.**  
The construction of distributors with perforated plate that ensures balanced airflow and low airflow resistance.

**Opening.**  
The openable design of pass-through distributors allows convenient maintenance.

**Additional sealing.**  
The additional sealing of the duct connection ensures even higher system tightness.

**Duct connector with a gasket.**  
The product is equipped with a steel connector and a rubber gasket, which facilitates installation and provides a tight connection.

**Mounting brackets.**  
Distribution boxes have mounting brackets (width 15mm) that facilitate installation.

**Height of distribution boxes.**  
The height of distribution boxes designed for ceiling installation is as follows: Ø75 = 82mm, Ø90 = 102mm.

**275 g/m<sup>2</sup> galvanization.**  
The high density of the zinc coating ensures the durability and corrosion resistance of the system.

**Pressed.**  
The pressed method is used in the production process to join individual elements, which preserves the zinc coating at the connection point.

**Insulation.**  
Lower heat loss, noise reduction of air flow.  
IZOLw - internally insulated element.  
Type of insulation: rubber mat.

**Self-sealing duct connectors.**  
A patented system with a self-sealing connection. It provides a tight connection without the use of gaskets. Quick installation. The system is rated as tightness class C.

**Long connection.**  
Long connection allows cutting it to the required length.





# Flexible duct

## FLEXTA SPECTRA 1000

### Description

Flexible ducts are designed for air distribution in ventilation and air conditioning systems. Small size, proper design and high mechanical resistance make the ducts extremely resistant to crushing and make it possible to lay them in the ceiling or floor. The interior of the wires is covered with an antibacterial and antifungal coating, thanks to which the system is resistant to the formation of fungi, mold or other adverse factors. Thanks to its antistatic properties, the interior is resistant to dirt and dust.

### FLEXTA SPECTRA 1000. Basic parameters.

#### Air flow volume (m<sup>3</sup>/h) for DN 75 mm

Air speed (m/s)	0,5	1,0	1,5	2,0	3,0	4,0	5,0
Air flow rate (m <sup>3</sup> /h)	5,3	10,5	15,8	21,0	31,6	42,1	52,6

#### Air flow volume (m<sup>3</sup>/h) for DN 90 mm

Air speed (m/s)	0,5	1,0	1,5	2,0	3,0	4,0	5,0
Air flow rate (m <sup>3</sup> /h)	7,8	15,7	23,5	31,4	47,1	62,8	78,5

### Properties

Fire reaction class	D-s2, d2 (PN-EN 13501-1)
Compression resistance	500 N (PN-EN 61386-24)
Material	Modified polyethylene (HDPE-mod)
Inner layer	Antibacterial layer (ISO 22196:2011), Antifungal (PN EN 846:2019), Antistatic

### Available duct diameters

Nominal size DN (mm)	
75	90
Inner diameter (mm)	
61	75
Outer diameter (mm)	
76,2	90,6
Minimum bending radius* (mm)	
0,17	0,25
Length of roll (m)	
50	50

\* Temperature above 10°C

### Ventilation ducts FLEXTA SPECTRA 1000. Antibacterial properties confirmed by research.

#### Reduction of bacteria in FLEXTA SPECTRA 1000 ducts.

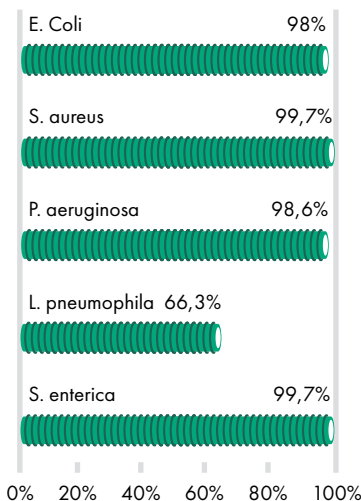

#### Effectiveness of limiting fungal growth in FLEXTA SPECTRA 1000 ducts.

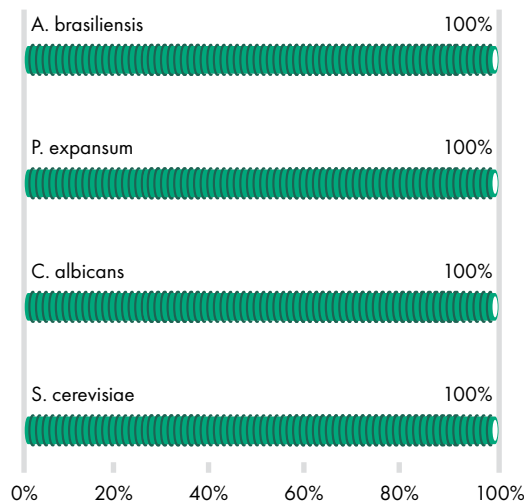

\*Based on tests conducted by the manufacturer.

### Characteristics

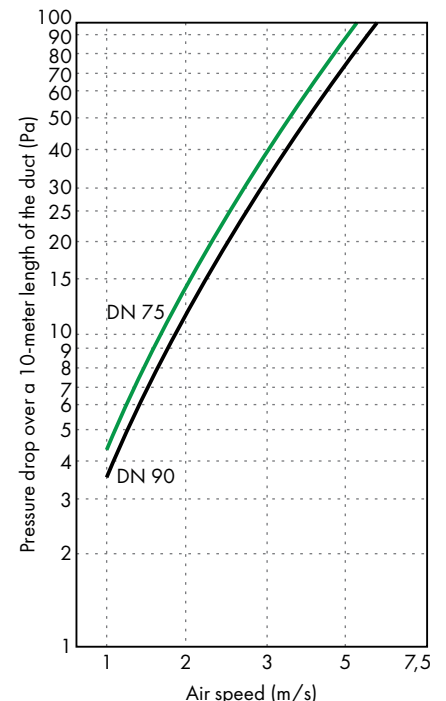



# Flexible duct FLEXO DUCT STANDARD

## Description

Flexible ducts are designed for air distribution in ventilation and air conditioning systems. Small size, proper design and high mechanical resistance make the ducts extremely resistant to crushing and make it possible to lay them in the ceiling or floor. The interior of the wires is covered with an antibacterial and antifungal coating, thanks to which the system is resistant to the formation of fungi, mold or other adverse factors. Thanks to its antistatic properties, the interior is resistant to dirt and dust.

## FLEXO DUCT STANDARD. Basic parameters.

### Air flow volume (m<sup>3</sup>/h) for DN 75 mm

Air speed (m/s)	0,5	1,0	1,5	2,0	3,0	4,0	5,0
Air flow rate (m <sup>3</sup> /h)	5,3	10,5	15,8	21,0	31,6	42,1	52,6

### Air flow volume (m<sup>3</sup>/h) for DN 90 mm

Air speed (m/s)	0,5	1,0	1,5	2,0	3,0	4,0	5,0
Air flow rate (m <sup>3</sup> /h)	7,8	15,7	23,5	31,4	47,1	62,8	78,5

## Properties

Fire reaction class	D-s2, d2 (PN-EN 13501-1)
Compression resistance	500 N (PN-EN 61386-24)
Material	Modified polyethylene (HDPE-mod)
Inner layer	Antibacterial layer Antifungal Antistatic

## Available duct diameters

Nominal size DN (mm)	
75	90
Inner diameter (mm)	
61	75
Outer diameter (mm)	
76,2	90,6
Minimum bending radius* (mm)	
0,17	0,25
Length of roll (m)	
50	50

\* Temperature above 10 °C

## FLEXO DUCT SPECTRA 1000 vs. FLEXO DUCT STANDARD. See comparison.

	Flexo Duct Spectra 1000	Flexo Duct Standard
Antistaticity	●●●●●●	●●●●●●
Antibacterial properties	●●●●●●	●●●●○
Antifungal properties	●●●●●●	●●●●○
Fluorescent inner layer	●●●●●●	●●●●○
Reaction to fire	●●●●○	●●●●○
Marketing support	●●●●●●	●●●●○
Research, certifications, declarations, attestations	●●●●●●	●●●●○
Warranty	30 years*	30 years*

\*Warranty period for flexible duct in places not exposed to UV radiation.

## Characteristics

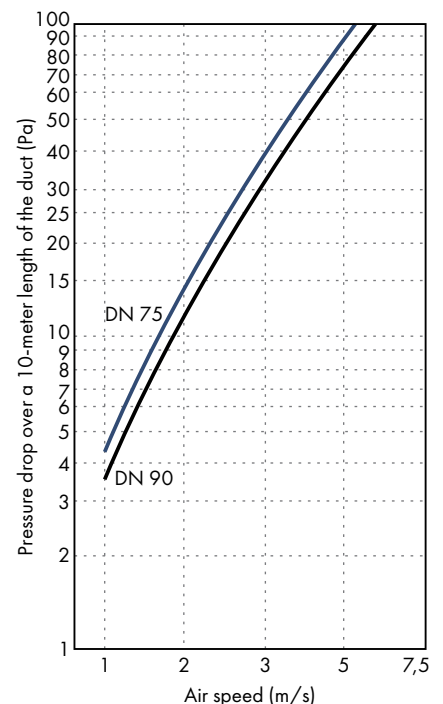

# Plenum box FLEXP BOX PRO T



Pressed



Highest quality galvanised steel  
275 g/m<sup>3</sup>



Indentations and blockages



Mounting brackets



Long connection  
280 mm

## Description

The **FLEXP BOX PRO T** is the connection element of the **FLEXP DUCT** ducts. Together they form a complete air distribution solution in mechanical ventilation (recuperation).

## Design

The box is made of galvanised steel. Inside the box is placed a profiled insert to minimize pressure loss. Thanks to the large number of pressed connections, the box is characterised by high tightness. Self-sealing connectors, made of high quality rubber with an additional structural built-in gasket, allow for a very fast and tight fitting of **FLEXP DUCT** ducts. On an individual request, it is possible to make a stainless steel box or to make internal insulation with a rubber mat.

## Usage

The **FLEXP BOX PRO T** junction box allows connection of air valves. Thanks to the large connector length, the box can easily be adjusted to different ceiling heights (partitions), without the need for additional connection elements.

## Exceptionally fast and easy installation without tools!



1. Inset the ventilation duct HAVACO FLEXP DUCT into a connector.



2. Press until you hear a click.

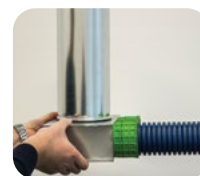

3. DONE - you have installed the duct in the box! And the whole thing is in the C tightness class!

## FLEXP BOX PRO T1 - technical drawing

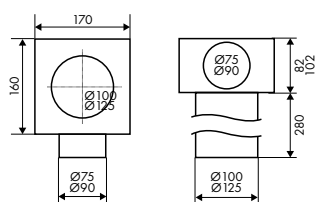

## FLEXP BOX PRO T1 - technical specifications

Model	Connectors [pcs.]	The diameter of connectors [mm]
FLEXP BOX PRO T1x75 / 100	1	1x75 / 100
FLEXP BOX PRO T1x75 / 125	1	1x75 / 125
FLEXP BOX PRO T1x90 / 100	1	1x90 / 100
FLEXP BOX PRO T1x90 / 125	1	1x90 / 125

## FLEXP BOX PRO T1 - characteristics

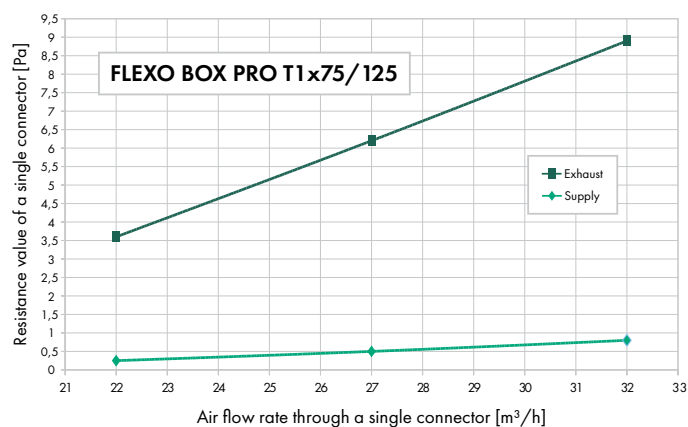



# Plenum box

## FLEVO BOX PRO T2 - technical drawing

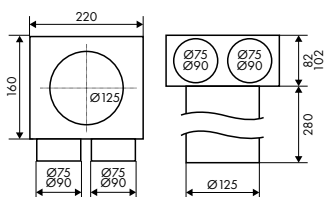

## FLEVO BOX PRO T2 - technical specifications

Model	Connectors [pcs.]	The diameter of connectors [mm]
FLEVO BOX PRO T2x75 / 125	2	2x75 / 125
FLEVO BOX PRO T2x90 / 125	2	2x90 / 125

## FLEVO BOX T2 - characteristics

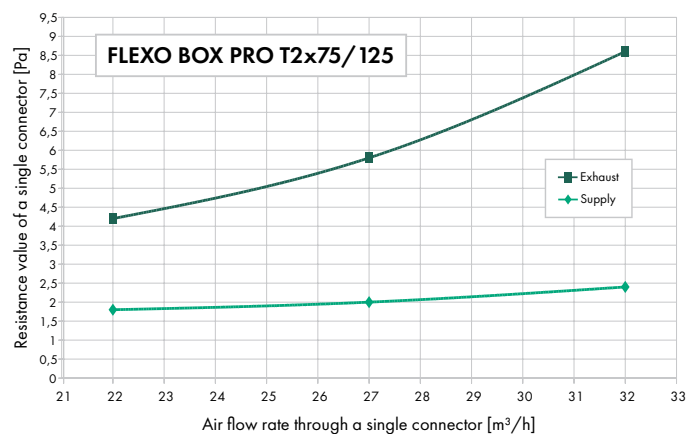

## FLEVO BOX PRO T3 - technical drawing

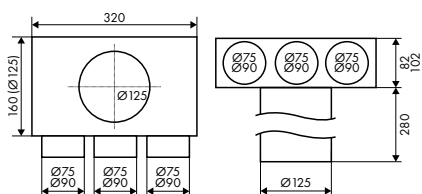

## FLEVO BOX PRO T3 - technical specifications

Model	Connectors [pcs.]	The diameter of connectors [mm]
FLEVO BOX PRO T3x75 / 125	3	3x75 / 125
FLEVO BOX PRO T3x90 / 125	3	3x90 / 125

## FLEVO BOX PRO T3 - characteristics

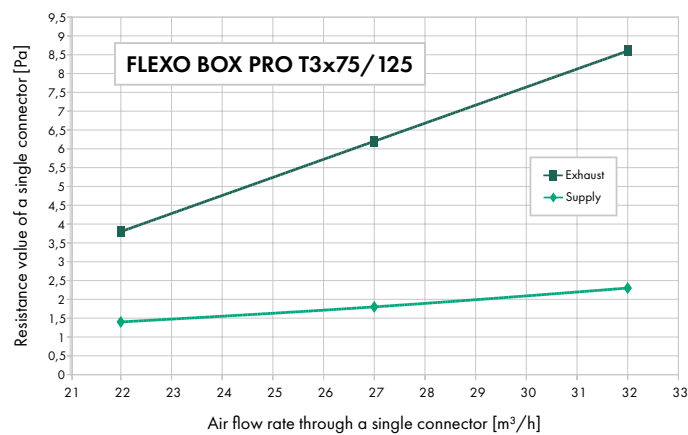

# Insulated manifolds FLEVO BOX PRO P

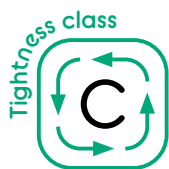

Highest quality galvanised steel  
275 g/m<sup>3</sup>



Indentations and blockages



Mounting brackets



Self-sealing connectors



Inner insulation  
10 mm



Opening revision



Perforated plate



Connector with a gasket

## Description

The **FLEVO BOX PRO P** is the connection element of the **FLEVO DUCT** flexible ducts. Together they create a complete air distribution solution in mechanical ventilation.

## Design

The box is made of galvanised steel, with internal insulation of 10 mm thick rubber mat. A perforated plate is placed inside the box for even air distribution and the removable cover acts as an inspection hatch. Thanks to the large number of pressed connections, the box is characterised by high tightness. Self-sealing connectors, made of high quality rubber with an additional structural built-in gasket, allow for a very fast and tight fitting of **FLEVO DUCT** ducts. On individual request, it is possible to make a stainless steel box.

## Usage

The **FLEVO BOX PRO P** junction box allows the main supply and exhaust sequences to be separated into an appropriate number of **FLEVO DUCT** ducts. Using **FLEVO END** plugs, you can easily adjust the number of working connectors to the needs of the installation.

## Exceptionally fast and easy installation without tools!

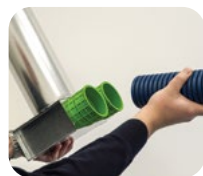

1. Inset the ventilation duct HAVACO FLEVO DUCT into a connector



2. Press until you hear a click.



3. DONE - you have installed the duct in the box! And the whole thing is in the C tightness class!

## FLEVO BOX PRO P8 - technical drawing

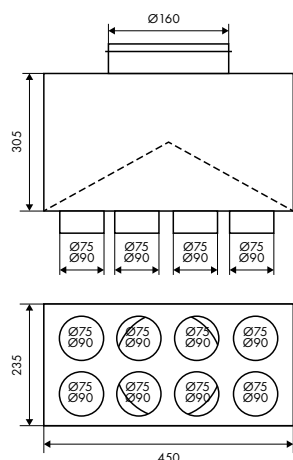

## FLEVO BOX PRO P8 - characteristics

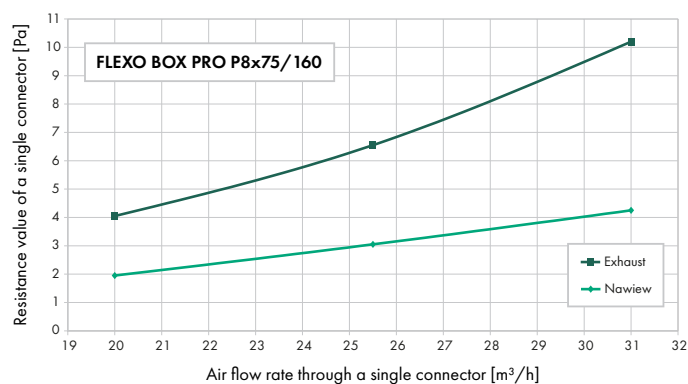

## FLEVO BOX PRO P8 - technical specifications

Model	Connectors [pcs.]	The diameter of connectors [mm]
FLEVO BOX PRO P8x75 / 160	8	8x75 / 160
FLEVO BOX PRO P8x90 / 160	8	8x90 / 160

# Insulated manifolds

## FLEVO BOX PRO P10 - technical drawing

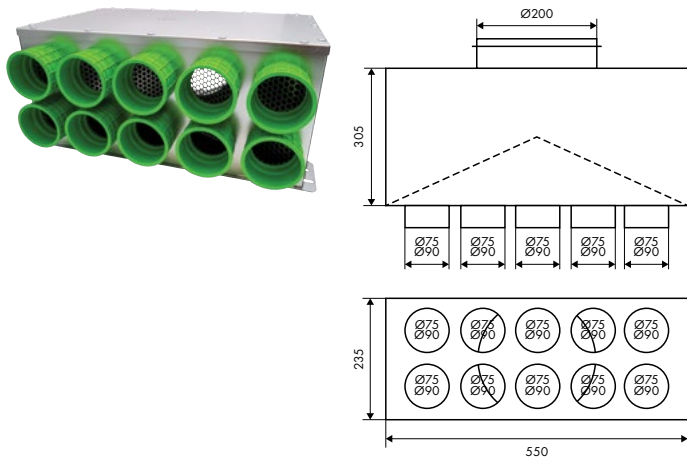

## FLEVO BOX PRO P10 - technical specifications

Model	Connectors [pcs.]	The diameter of connectors [mm]
FLEVO BOX PRO P10x75 / 200	10	10x75 / 200
FLEVO BOX PRO P10x90 / 200	10	10x90 / 200

## FLEVO BOX PRO P12 - technical drawing

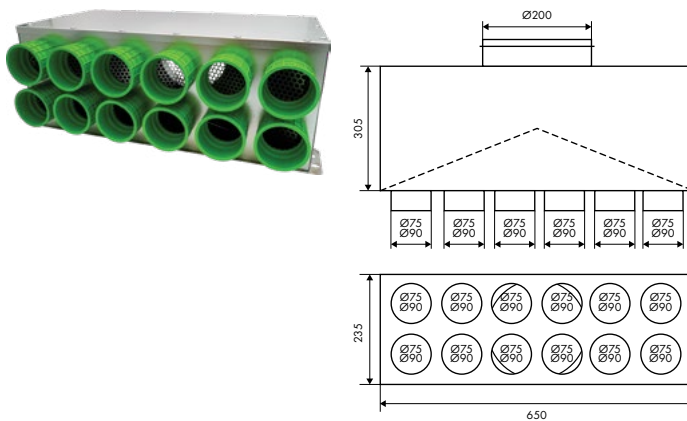

## FLEVO BOX PRO P12 - technical specifications

Model	Connectors [pcs.]	The diameter of connectors [mm]
FLEVO BOX PRO P12x75 / 200	12	12x75 / 200
FLEVO BOX PRO P12x90 / 200	12	12x90 / 200

## FLEVO BOX PRO P14 - technical drawing

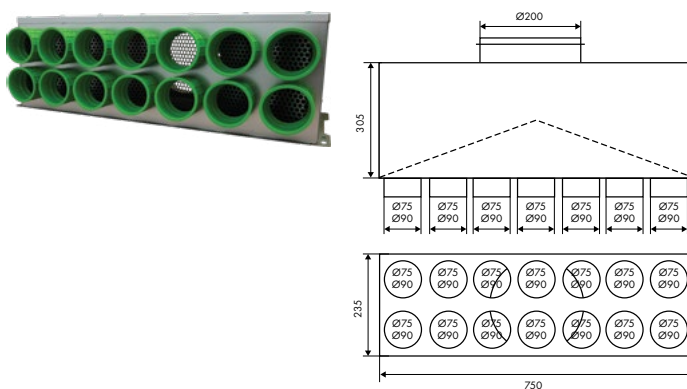

## FLEVO BOX PRO P14 - technical specifications

Mode	Connectors [pcs.]	The diameter of connectors [mm]
FLEVO BOX PRO P14x75 / 200	14	14x75 / 200
FLEVO BOX PRO P14x90 / 200	14	14x90 / 200

## FLEVO BOX PRO P10 - characteristics

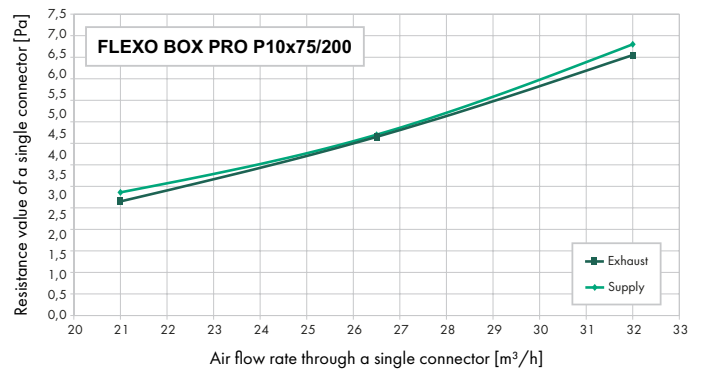

## FLEVO BOX PRO P12 - characteristics

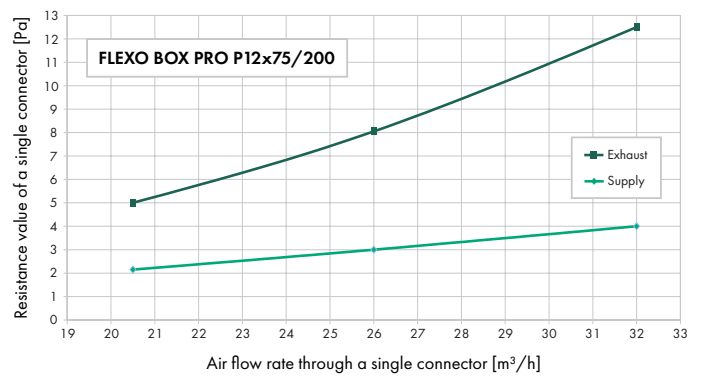

## FLEVO BOX PRO P14 - characteristics

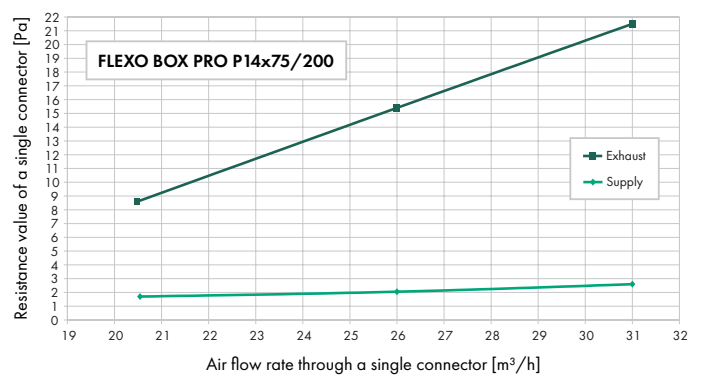

# 1-row angle insulated manifolds

## FLEXY BOX PRO K



Tightness class

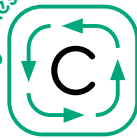

Highest quality galvanised steel  
275 g/m<sup>2</sup>



Self-sealing connectors



Indentations and blockages



Inner insulation: 3 mm



Additional sealing

### Description

The FLEXY BOX PRO K is the connection element of the **FLEXY DUCT** flexible ducts. Together they create a complete air distribution solution in mechanical ventilation.

### Design

The box is made of galvanised steel, with an internal insulation of 3 mm thick rubber mat. Inside the box is placed a profiled insert to minimise pressure loss. Thanks to the large number of pressed connections, the box is characterised by high tightness. Self-sealing connectors, made of high quality rubber with an additional structural built-in gasket, allow for very fast and tight fitting of **FLEXY DUCT** channels. On individual request, it is possible to make a stainless steel box.

### Usage

The **FLEXY BOX K** junction box allows for a perpendicular separation of the main supply and exhaust sequences into an appropriate number of **FLEXY DUCT** ducts. Using **FLEXY END** plugs, you can easily adjust the number of working connectors to the needs of the installation. Thanks to the large length of the connector, the box can be adapted to various types of partitions, without the need for additional connection elements.

### Exceptionally fast and easy installation without tools!



1. Inset the ventilation duct HAVACO FLEXY DUCT into a connector.



2. Press until you hear a click.

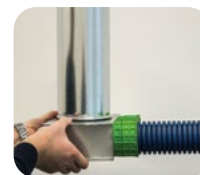

3. **DONE** - you have installed the duct in the box! And the whole thing is in the C tightness class!

### FLEXY BOX PRO K8K - technical drawing

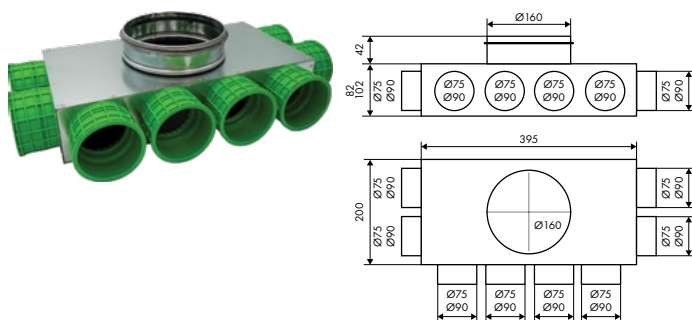

### FLEXY BOX PRO K8K - characteristics

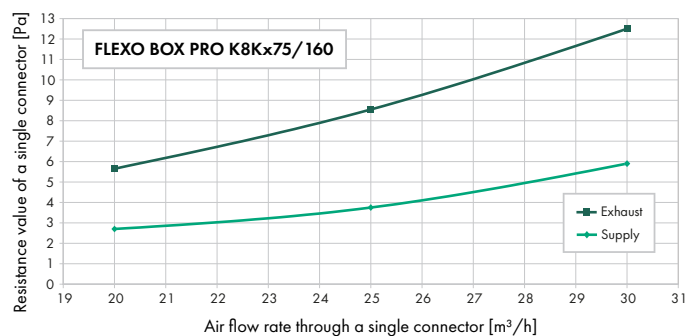

### FLEXY BOX PRO K8K - technical specifications

Mode	Connectors [pcs.]	The diameter of connectors [mm]
FLEXY BOX PRO K8Kx75 / 160	8	8x75 / 160
FLEXY BOX PRO K8Kx90 / 160	8	8x90 / 160

# 1-row angle insulated manifolds

## FLEVO BOX PRO K10K - technical drawing

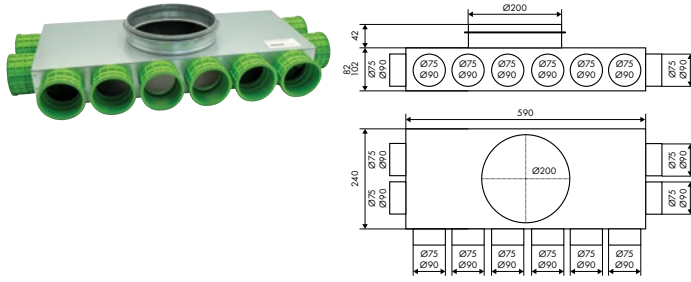

## FLEVO BOX PRO K10K - technical specifications

Model	Connectors [pcs.]	The diameter of connectors [mm]
FLEVO BOX PRO K10Kx75 / 200	10	10x75 / 200
FLEVO BOX PRO K10Kx90 / 200	10	10x90 / 200

## FLEVO BOX PRO K10K - characteristics

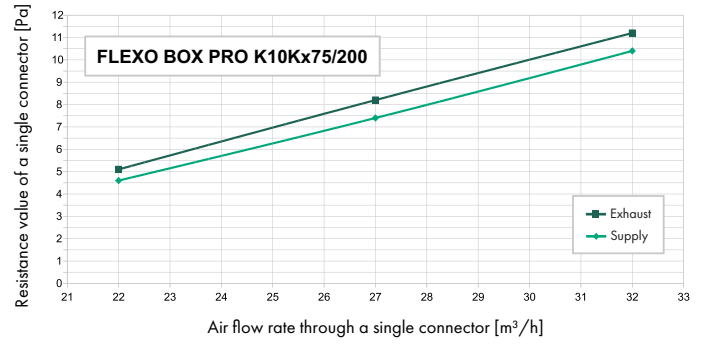

## FLEVO BOX PRO K12K - technical drawing

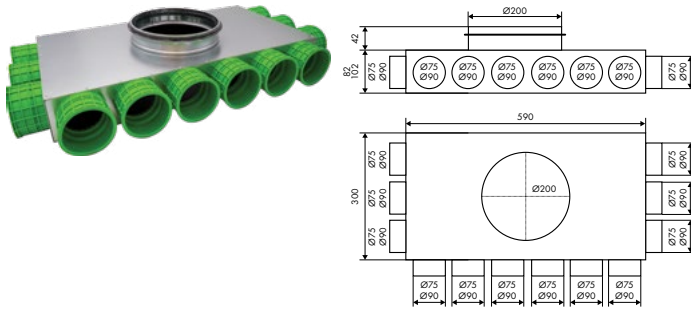

## FLEVO BOX PRO K12K - technical specifications

Model	Connectors [pcs.]	The diameter of connectors [mm]
FLEVO BOX PRO K12Kx75 / 200	12	12x75 / 200
FLEVO BOX PRO K12Kx90 / 200	12	12x90 / 200

## FLEVO BOX PRO K12K - characteristics

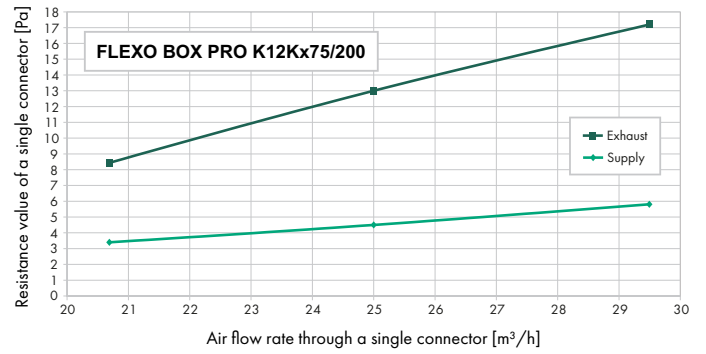

## FLEVO BOX PRO K14K - technical drawing

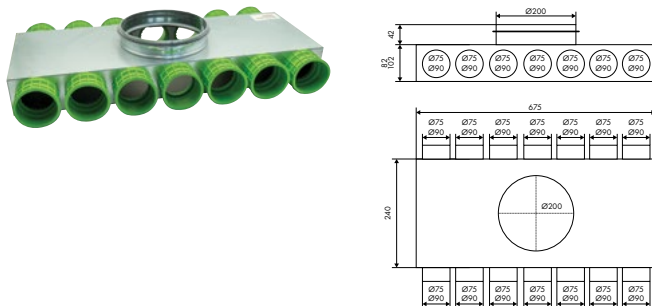

## FLEVO BOX PRO K14K - technical specifications

Model	Connectors [pcs.]	The diameter of connectors [mm]
FLEVO BOX PRO K14Kx75 / 200	14	14x75 / 200
FLEVO BOX PRO K14Kx90 / 200	14	14x90 / 200

## FLEVO BOX PRO K14K - characteristics

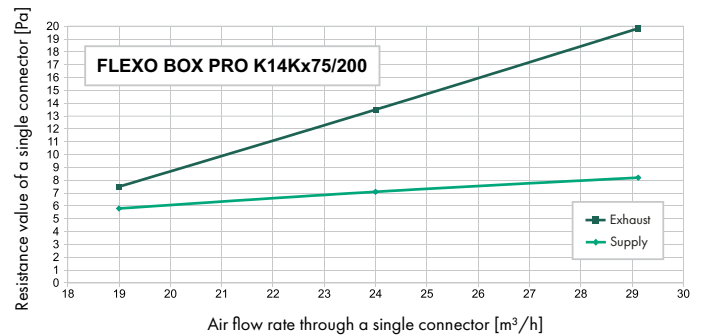

# Linear insulated manifolds **FLEXP BOX PRO L**

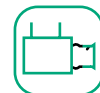

Highest quality galvanised steel  
275 g/m<sup>2</sup>

Self-sealing connectors

Indentations and blockages

Inner insulation: 3 mm

Additional sealing

## Description

The **FLEXP BOX PRO L** is the connection element of the **FLEXP DUCT** flexible ducts. Together they create a complete air distribution solution in mechanical ventilation.

## Design

The box is made of galvanised steel, with an internal insulation of 3 mm thick rubber mat. Inside the box is placed a profiled insert to minimise pressure loss. Thanks to the large number of pressed connections, the box is characterised by high tightness. Self-sealing connectors, made of high quality rubber with an additional structural built-in gasket, allow for very fast and tight fitting of **FLEXP DUCT** channels. On individual request, it is possible to make a stainless steel box.

## Usage

The **FLEXP BOX L** junction box allows for a perpendicular separation of the main supply and exhaust sequences into an appropriate number of **FLEXP DUCT** ducts. Using **FLEXP END** plugs, you can easily adjust the number of working connectors to the needs of the installation. Thanks to the versatility of the box, the side of the construction (left or right) can be determined already at the stage of assembly in a very simple and quick way by turning the box connection by 180°.

## Exceptionally fast and easy installation without tools!



**1.** Insert the ventilation duct HAVACO Flexo DUCT into a connector.



**2.** Press until you hear a click.

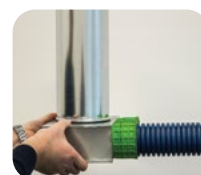

**3.** DONE - you have installed the duct in the box! And the whole thing is in the C tightness class!

## Change the direction of the manifold in four simple steps

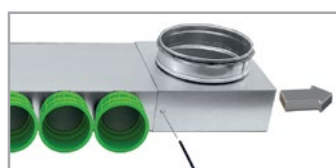
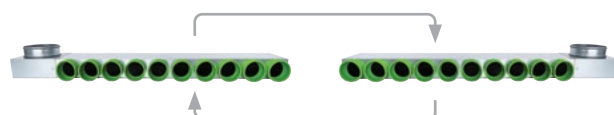

**1**  
Rotate the channel connection fitting.

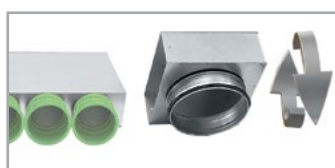

**2**  
Turn it.

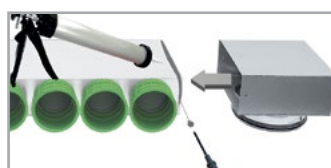

**3**  
Assemble the fitting again, sealing the connection with silicone or tape.

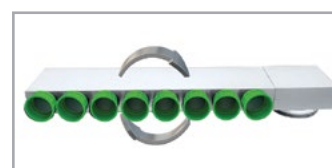

**4**  
Rotate the distribution box by 180°

# Linear insulated manifolds

## FLEVO BOX PRO L 8U - technical drawing

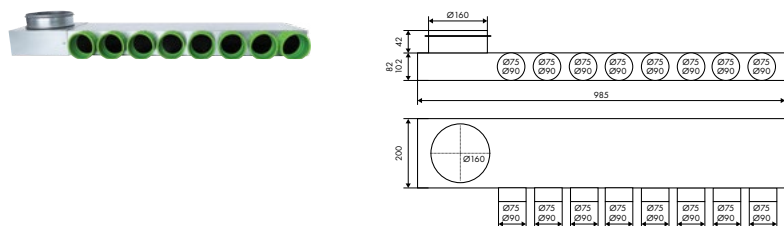

## FLEVO BOX PRO L 8U - technical specifications

Model	Connectors [pcs.]	The diameter of connectors [mm]
FLEVO BOX PRO L8Ux75 / 160	8	8x75 / 160
FLEVO BOX PRO L8Ux90 / 160	8	8x90 / 160

## FLEVO BOX PRO L 10U - technical drawing

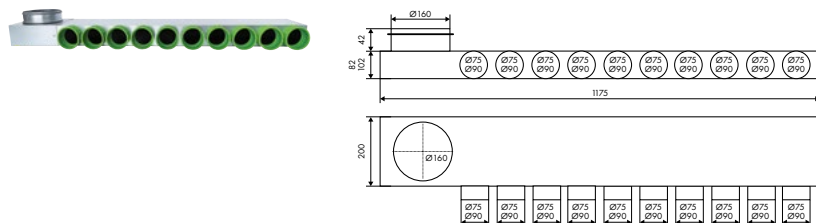

## FLEVO BOX PRO L 10U - technical specifications

Model	Connectors [pcs.]	The diameter of connectors [mm]
FLEVO BOX PRO L10Ux75 / 160	10	10x75 / 160
FLEVO BOX PRO L10Ux90 / 160	10	10x90 / 160



# Flat manifolds for self-configuration FLEXO MODULE SYSTEM



Highest quality galvanised steel  
275 g/m<sup>2</sup>



Self-sealing connectors



Connector with a gasket



For self-configuration



Unlimited number of possibilities



Easy assembly



Complete system

## Unlimited number of possibilities

**HAVACO FLEXO MODULE SYSTEM** is an innovative solution that allows for the self-configuration of any flat distribution box according to one's own idea. With several components at our disposal, we can plan and implement a distribution box perfectly tailored to the specifics of our project. Importantly, if it turns out on-site that any changes are needed in the quantity or placement of outlets, we can make them immediately without to order additional, non-standard elements. System components are available for diameters Ø75 and connections with diameters Ø160 and Ø200.



## Your own box



1

Consider the concept of your distribution box.



2

Complete all elements

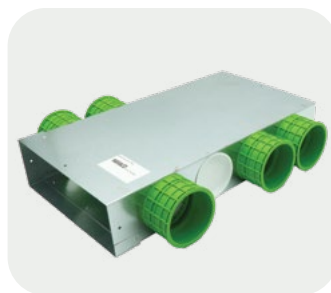

3

Assemble elements



4

Integrate all the components into a cohesive whole.

## Simple box configuration!



1. Prepare the box and the other elements



2. Spray the edge with silicone.



3. Put elements in gaps



4. Plug any unused openings in the box.

## Quick and easy box assembly



1. You only need: sheet metal screws, a screwdriver, and 50mm sealing tape.

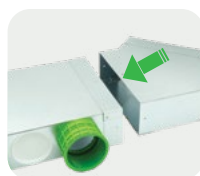

2. The elements connect in the mufan system, without any additional connectors.



3. Fasten individual fittings using sheet metal screws. The holes are already prepared.



4. Seal all joints with tape.



# Flat manifolds for self-configuration

## Supply fitting

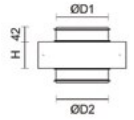
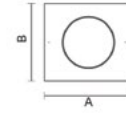
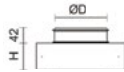
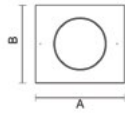

Model	Connectors [pcs.]	The diameter of connectors [ØD mm] [ØD1 / ØD2 mm]	Box dimensions [AxBxH mm]	Description
FLEKO MODULE PZ 75x160	-	160	270x239x82	Supply fitting PZ 75x160 with gasket
FLEKO MODULE PZ 75x200	-	200	270x239x82	Supply fitting PZ 75x200 with gasket
FLEKO MODULE PZ 75x200/160	-	200/160	270x239x82	Supply fitting PZ 75x200/160 with gasket
FLEKO MODULE PZ 75x200/200	-	200/200	270x239x82	Supply fitting PZ 75x200/200 with gasket

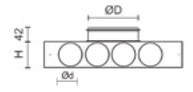
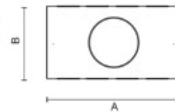
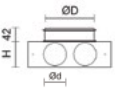
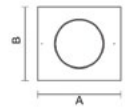

Model	Connectors [pcs.]	The diameter of connectors [Ød / ØD mm]	Box dimensions [AxBxH mm]	Description
FLEKO MODULE PZ 75x160-4	4	75/160	270x239x82	Supply fitting PZ 75x160-4 with gasket
FLEKO MODULE PZ 75x200-4	4	75/200	270x239x82	Supply fitting PZ 75x200-4 with gasket
FLEKO MODULE PZ 75x200-8	8	75/200	440x239x82	Supply fitting PZ 75x200-8 with gasket

## Module fitting

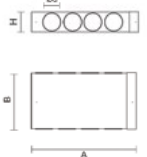
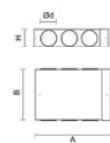
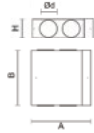
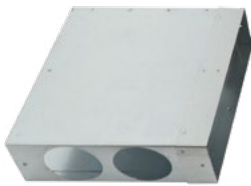

Model	Connectors [pcs.]	The diameter of connectors [Ød mm]	Box dimensions [AxBxH mm]	Description
FLEKO MODULE M 75x4	4	75	258x239x82	Module fitting M 75x4
FLEKO MODULE M 75x6	6	75	325x239x82	Module fitting M 75x6
FLEKO MODULE M 75x8	8	75	440x239x82	Module fitting M 75x8

## Additional components (thru-wall, bend, plug, connector)



Model	Angle	Box dimensions [AxBxH mm]	Description	Model	The diameter of connector [Ød mm]	Description
FLEKO MODULE K 75x45	45°	279x239x82	Bend K 75x45, 45 angle	FLEKO Connector PRO	75	Self-sealing connectors, green
FLEKO MODULE K 75x90	90°	314x239x82	Bend K 75x90, 90 angle	FLEKO MODULE Z 75 White	75	Plastic plug Z 75, white



Model

Model	Box dimensions [AxBxH mm]	Description	Connectors [pcs.]/ diameter [Ø mm]	Steel plug dimensions [AxBxH mm]	Description
FLEKO MODULE Z 75x0K	-	30x239x82	-	30x239x82	Full plug Z 75x0K
FLEKO MODULE P 75x300	325x239x82	Thru-wall fitting	2/75	30x239x82	2 holes plug* Z 75x2K

\* self-sealing connectors sold separately

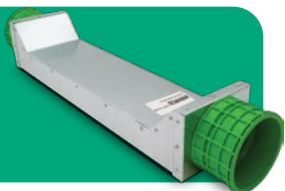

## Flat duct bypass FLEXO PRO BYPASS

### Description

Flat duct bypass made of galvanised steel. 75 mm diameter connector are available. Self-sealing connector.

### Technical specifications

Model	Connectors [pcs.]	The diameter of connectors [mm]
FLEXO PRO BYPASS 1x75	1	1x75
FLEXO PRO BYPASS 1x90	1	1x90

### Technical drawing

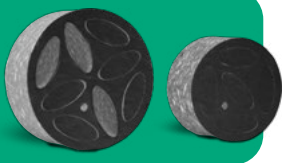
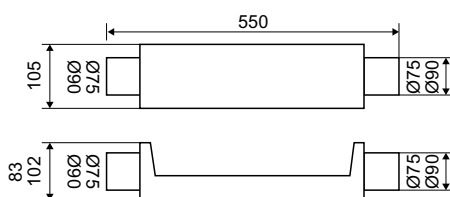

## Silencing damper FLEXO DAMPER

### Description

The dampers are made of polyurethane foam, used to regulate the flow and noise suppression in the installation. Air flow can be easily adjusted by changing the number of open holes in the damper. Several dampers should be used for greater damping. Polyurethane foam in the field of fire resistance meets the requirements of FMVSS-302.

### Technical specifications

Model	Diameter [mm]
FLEXO DAMPER 100	100
FLEXO DAMPER 125	125
FLEXO DAMPER 160	160
FLEXO DAMPER 200	200
FLEXO DAMPER 250	250

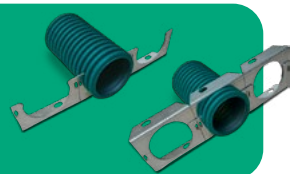

## Flexible duct mounting FLEXO HOLDER

### Technical specifications

Model	Diameter [mm]
FLEXO HOLDER 75	75
FLEXO HOLDER 90	90

## Box end cap FLEXO END



### Description

The FLEXO END CUP is used to close unused connectors. Made of plastic.

### Technical specifications

Model	Diameter [mm]
FLEXO END 75	75
FLEXO END 90	90

## Duct link FLEXO LINK PRO



### Description

The FLEXO DUCT LINK PRO connector is used to connect flexible FLEXO DUCT ducts. Made of plastic.

### Technical specifications

Model	Diameter [mm]
FLEXO LINK PRO 75	75
FLEXO LINK PRO 90	90

## Corrugated duct cutter FLEXO CUTTER



### Technical specifications

Model	Diameter [mm]
FLEXO CUTTER 75	75
FLEXO CUTTER 90	90



## Silicone spray **FLEXPOLYMER**

### Description

The lubricant agent preserves metal, rubber, plastic and wooden elements.

### Application

Facilitates assembling of PVC pipes, drawing electrical cables in tubes, lubricates the rubber seals, chains, hinges, locks, fittings and tools. It eliminates sand and gridding of sliding elements.

### Technical specifications

The spray is extremely suitable as a lubrication and friction agent.

Resistant to temperatures from  $-40^{\circ}\text{C}$  to  $250^{\circ}\text{C}$ .

Preserves the sprayed surfaces.

Protects the parts against corrosion, deposition of dirt, drying, freezing and clumping. Also, it supremely displaces the water.

Odourless.

# Fans

Bathroom • Duct • Roof • Axial • Radial

HAVACO fans combine high quality with affordability and attractive prices. Each type of product is offered in a wide range of sizes and performance levels, as well as with different equipment - both standard and optional (regulators and controls, mounting accessories). The most popular models are available non-stop in the warehouse.



High quality

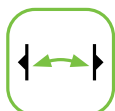

A wide range



Availability from  
the warehouse



Attractive price

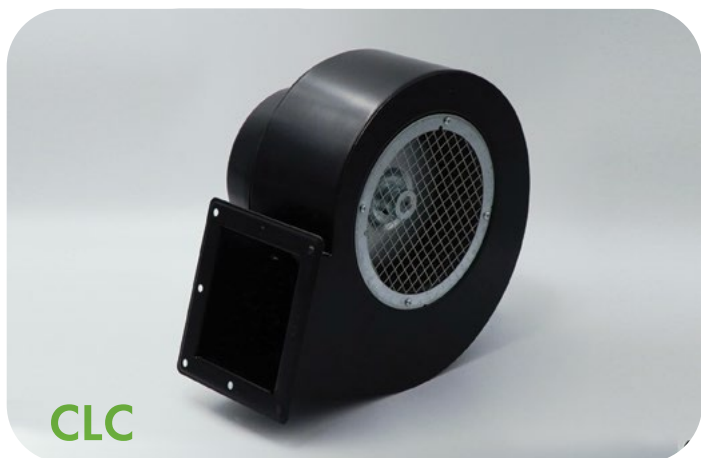
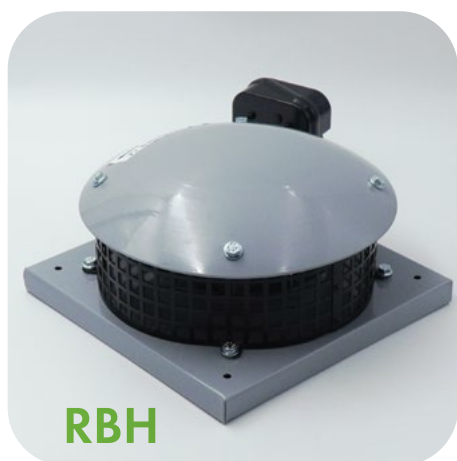

# Bathroom fans

## COMO Silent



Exceptionally quiet operation



IP 45 protection class



Return damper



Time delay

### Design

Axial, wall mounted fan. The enclosure is made of impact-resistant and UV-resistant ABS plastic in RAL 9010. Original rotor design aerodynamic inlet shape and distribution of the deflectors provide higher efficiency, lower energy consumption and lower noise levels. The unit is equipped with an integrated return damper. The fan can be installed both horizontally and vertically.

#### Standard version S:

The fan is operated by means of a separate ON/OFF button or by a light switch.

#### Time delay version T:

The device is equipped with a timed operating system which is adjustable from approx. 1 minute to 25 minutes using the built-in potentiometer.

### Electric motor

Single-speed motor, powered by single-phase current 220-240V, 50/60Hz. IP 45 protection class. The motor is equipped with durable ball bearings and thermal protection of the winding against overload.

### Usage

The COMO Silent fan is designed for ventilation of small and medium spaces. Ideally suited for air-extraction installation in bathrooms, toilet or kitchen.

### Operating temperature

The fan is designed to transmit air with a temperature not exceeding 50°C.

### Technical specifications

Model	Air flow [m <sup>3</sup> /h]	Power [W]	Voltage [V]	Frequency [Hz]	Sound pressure level [dB(A)]	Weight [kg]
COMO Silent 100 S/T	95	8	220-240	50/60	25	0,5

### Technical drawing

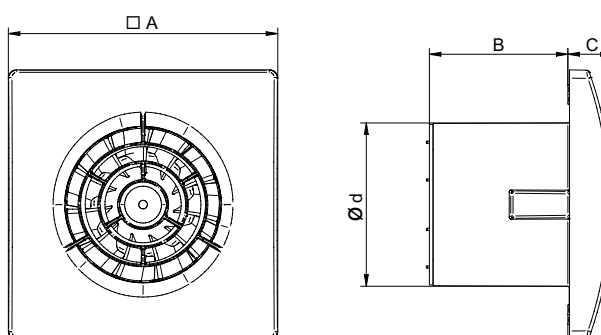

### Dimensions [mm]

Model	A	B	C	Ød
COMO Silent 100	164	84	27	99,5

### Characteristics

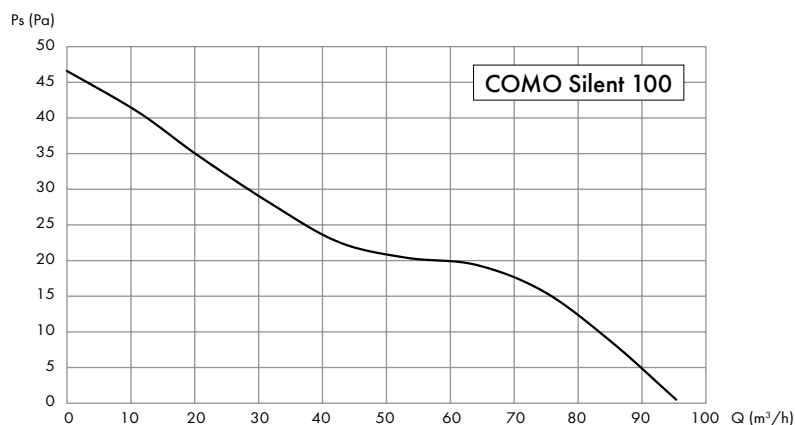



# Bathroom fans

## COMO Design / QD



Hidden fan



IP 45 protection class



Return damper



Time delay

### Design

Axial, wall mounted fan. The enclosure is made of impact-resistant and UV-resistant ABS plastic in RAL 9010. Original rotor design aerodynamic inlet shape and distribution of the deflectors provide higher efficiency, lower energy consumption and lower noise levels. The unit is equipped with an integrated return damper. The aesthetics of the device come from the front fan cover. The fan can be installed both horizontally and vertically.

#### Standard version S:

The fan is operated by means of a separate ON/OFF button or by a light switch.

#### Time delay version T:

The device is equipped with a timed operating system which is adjustable from approx. 1 minute to 25 minutes using the built-in potentiometer.

#### Version with hygostat and HT time delay:

The appliance is equipped with a humidity sensor and a timer system that is adjustable from about 1 minute to 25 minutes using the built-in potentiometer.

### Electric motor

Single-speed motor, powered by single-phase current 220-240V, 50/60Hz. IPX4 protection class. The motor is equipped with durable ball bearings and thermal protection of the winding against overload.

### Usage

The COMO Silent fan is designed for ventilation of small and medium spaces. Ideally suited for air-extraction installation in bathrooms, toilet or kitchen.

### Operating temperature

The fan is designed to transmit air with a temperature not exceeding 50°C.

### Technical specifications

Model	Air flow [m <sup>3</sup> /h]	Power [W]	Voltage [V]	Frequency [Hz]	Sound pressure level [dB(A)]	Weight [kg]
COMO Design 100 S/T/HT	83	8	220-240	50/60	26	0,6
QD 120 BB S/T	140	14	220-240	50/60	34	0,9
COMO Design 150 S/T	253	24	220-240	50/60	42	1,2

### Technical drawing

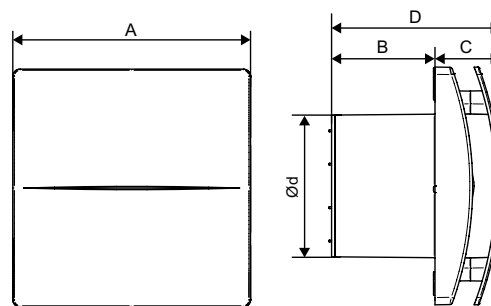

### Dimensions [mm]

Model	A	B	C	D	Ød
COMO Design 100	164	70	46	116	99
QD 120 BB	184	81	48	129	119
COMO Design 150	218	97	52	149	149

### Characteristics

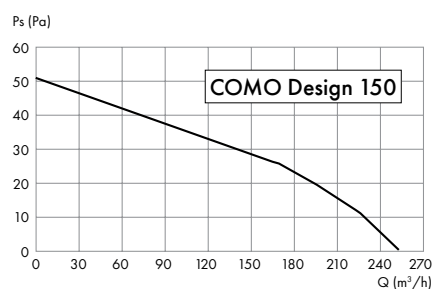
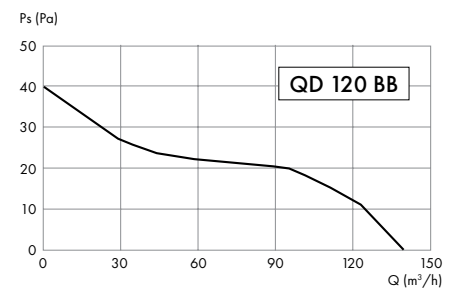
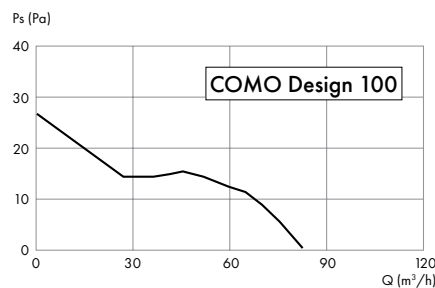



## Duct fans ICB



A wide range



IP 44 protection class



Perfectly balanced rotor

### Design

Duct fan, radial. The housing is made of steel sheet, powder coated in colour RAL 7030. The rotor is made of galvanised sheet with backward curved impeller, dynamically balanced. The junction box is attached directly to the case.

### Usage

The fan is designed to transport clean air. It is perfect for any supply installation, as well as for exhaust installations in apartments, offices, shops, hospitals, as well as industrial installations.

### Technical specifications

Model	Air flow [m <sup>3</sup> /h]	Impeller speed [rpm]	Power [W]	Current [A]	Voltage [V]	Frequency [Hz]	Capacitor [µF]	Sound pressure level [dB(A)]	Weight [kg]	Controller HRX	Controller HRB
ICB-100/250 M	240	2610	60	0,3	230	50	2,0	44	2,6	1,0	1,5
ICB-125/350 M	315	2325	80	0,4	230	50	2,5	43	2,7	1,0	1,5
ICB-150/450 M	420	2450	78	0,4	230	50	2,5	46	3,0	1,0	1,5
ICB-160/400 M	440	2550	85	0,4	230	50	2,5	45	3,2	1,0	1,5
ICB-200/850 M	735	2300	90	0,43	230	50	2,5	46	4,4	1,0	1,5
ICB-200/1000 M	870	2530	100	0,51	230	50	4,0	48	4,8	1,0	1,5
ICB-250/1100 M	1010	2400	140	0,69	230	50	4,0	45	4,9	1,0	1,5
ICB-250/1250 M	1150	2650	145	0,74	230	50	6,0	47	5,3	1,0	1,5
ICB-315/1600 M	1450	2400	160	0,8	230	50	6,0	48	6,8	2,5	1,5
ICB-315/1900 M	1750	2500	180	0,87	230	50	7,0	49	6,9	2,5	1,5
ICB-355/1450 M	1300	1450	160	1,0	230	50	4,0	45	9,0	2,5	1,5

Sound pressure level measured at 3m.

### Technical drawing

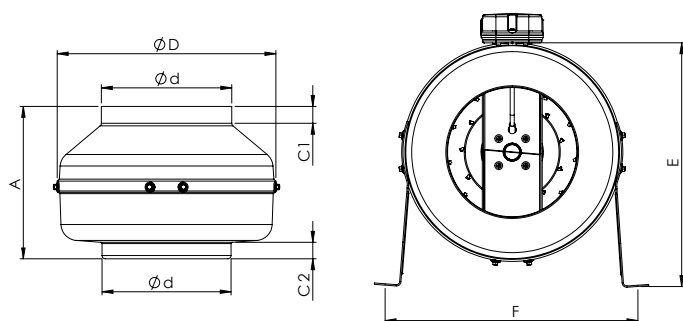

### Dimensions [mm]

Model	ØD	Ød	C1	C2	A	E	F
ICB-100	245	97	20	20	197	273	268
ICB-125	245	122	20	20	188	273	268
ICB-150	272	147	23	25	192	286	295
ICB-160	272	157	23	25	192	286	295
ICB-200	330	196	30	28	230	380	352
ICB-250	330	247	30	28	227	380	352
ICB-315	400	313	30	30	285	415	422
ICB-355	400	352	30	30	378	415	422

### Accessories



#### HRX

Electronic speed controller  
page 174



#### FKOV

Filter G3 for round ducts  
page 83



#### AKUFLEX

Flexible acoustic silencer  
page 71



#### RSKV

Backdraft damper  
page 41



#### HRB

Transformer speed controller  
page 176



#### WSH

Service switch  
page 177



#### PCC

Fastening clamp  
page 81



#### PSH

Pressure switch  
page 173



## Characteristics

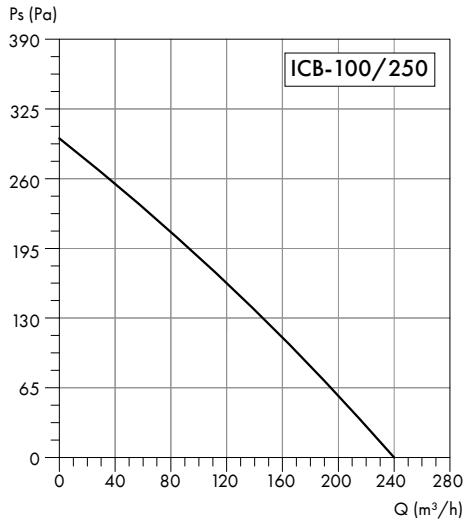

Frequency	Total	63	125	250	500	1000	2000	4000	8000	Hz
L <sub>WA</sub> Inlet	71	53	65	62	65	64	60	52	42	dB(A)
L <sub>WA</sub> Outlet	68	54	64	58	62	61	58	50	40	dB(A)
L <sub>WA</sub> Emitted	51	29	17	30	47	46	45	39	27	dB(A)

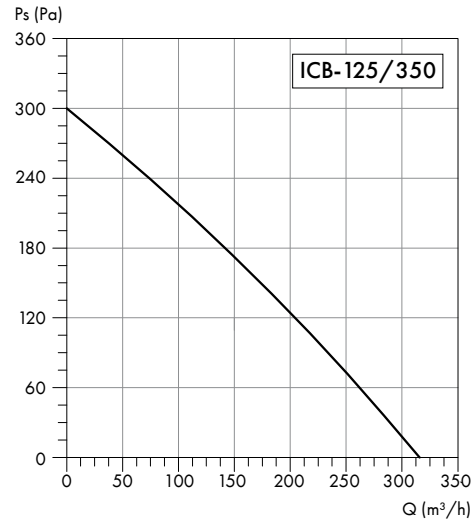

Frequency	Total	63	125	250	500	1000	2000	4000	8000	Hz
L <sub>WA</sub> Inlet	70	47	63	64	65	63	60	55	45	dB(A)
L <sub>WA</sub> Outlet	68	49	62	59	62	61	58	52	43	dB(A)
L <sub>WA</sub> Emitted	50	20	20	39	45	44	43	36	30	dB(A)

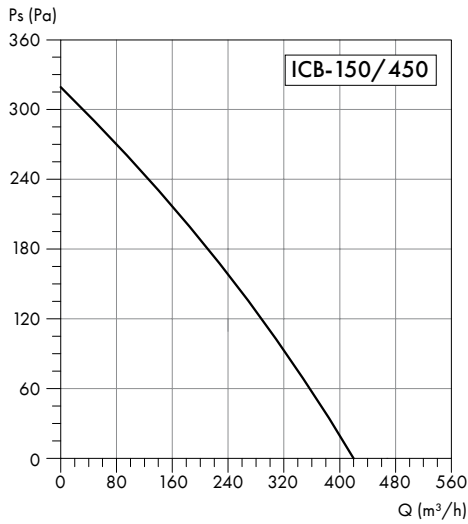

Frequency	Total	63	125	250	500	1000	2000	4000	8000	Hz
L <sub>WA</sub> Inlet	76	52	73	65	69	67	62	60	50	dB(A)
L <sub>WA</sub> Outlet	74	55	71	62	68	64	62	55	50	dB(A)
L <sub>WA</sub> Emitted	53	20	35	37	50	45	46	44	32	dB(A)

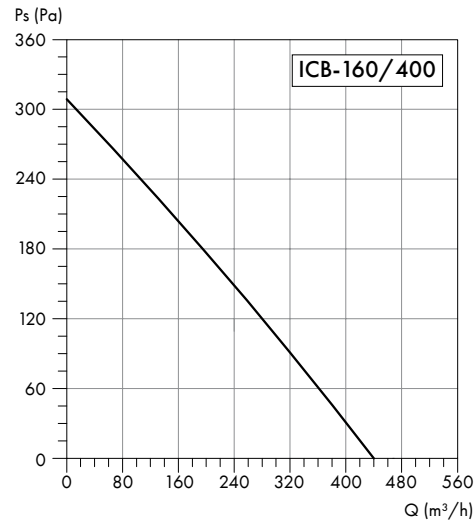

Frequency	Total	63	125	250	500	1000	2000	4000	8000	Hz
L <sub>WA</sub> Inlet	75	50	70	66	71	68	45	58	48	dB(A)
L <sub>WA</sub> Outlet	76	56	74	61	69	66	62	56	48	dB(A)
L <sub>WA</sub> Emitted	52	10	32	36	48	46	45	42	28	dB(A)

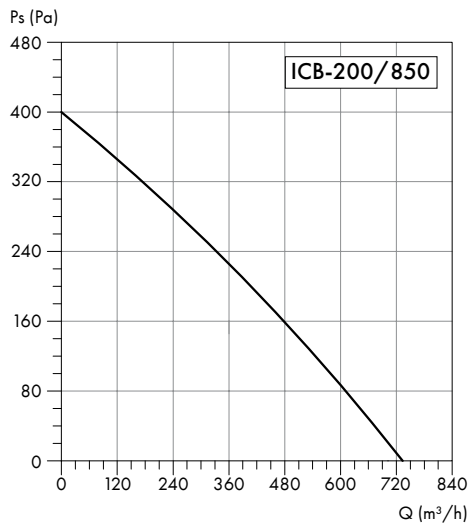

Frequency	Total	63	125	250	500	1000	2000	4000	8000	Hz
L <sub>WA</sub> Inlet	70	42	61	64	63	64	63	56	54	dB(A)
L <sub>WA</sub> Outlet	71	49	59	62	65	64	64	58	53	dB(A)
L <sub>WA</sub> Emitted	53	8	25	32	45	49	47	42	38	dB(A)

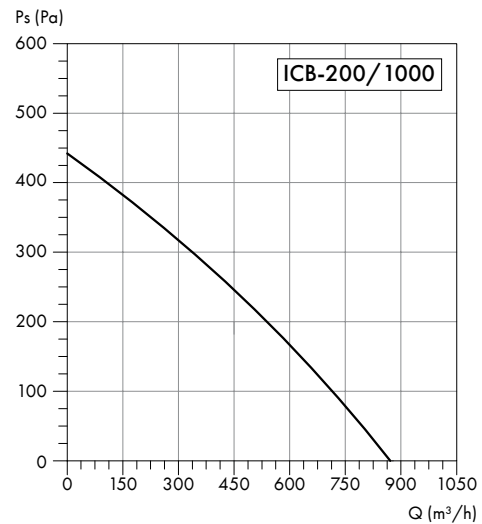

Frequency	Total	63	125	250	500	1000	2000	4000	8000	Hz
L <sub>WA</sub> Inlet	71	42	61	64	64	64	63	56	54	dB(A)
L <sub>WA</sub> Outlet	72	49	60	63	66	64	66	58	53	dB(A)
L <sub>WA</sub> Emitted	54	8	35	40	47	50	47	45	40	dB(A)



# Characteristics

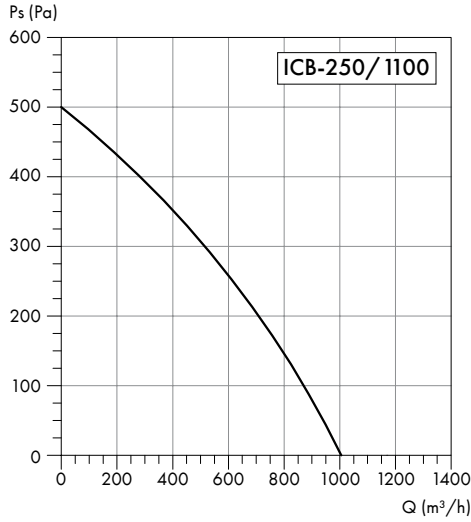

Frequency	Total	63	125	250	500	1000	2000	4000	8000	Hz
L <sub>WA</sub> Inlet	70	49	59	65	61	64	61	60	50	dB(A)
L <sub>WA</sub> Outlet	71	48	60	65	61	65	63	61	51	dB(A)
L <sub>WA</sub> Emitted	52	27	28	46	45	47	45	42	30	dB(A)

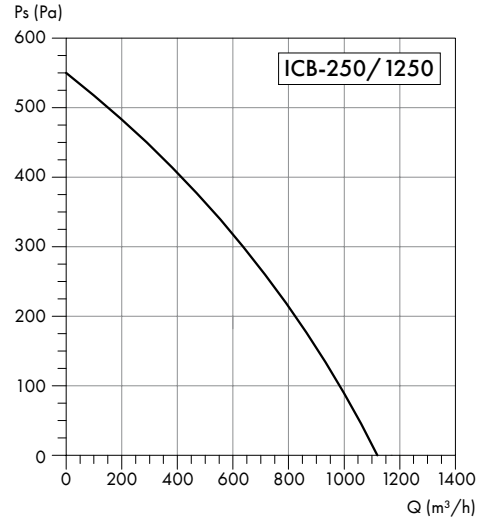

Frequency	Total	63	125	250	500	1000	2000	4000	8000	Hz
L <sub>WA</sub> Inlet	70	49	59	65	62	65	61	60	50	dB(A)
L <sub>WA</sub> Outlet	71	48	60	65	61	65	63	61	51	dB(A)
L <sub>WA</sub> Emitted	54	28	29	47	47	49	45	43	30	dB(A)

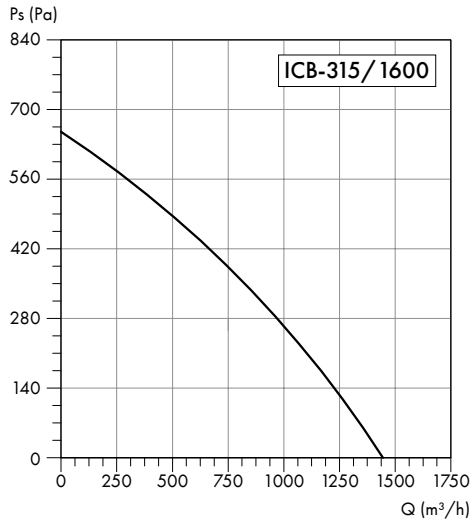

Frequency	Total	63	125	250	500	1000	2000	4000	8000	Hz
L <sub>WA</sub> Inlet	72	46	60	65	64	66	63	64	53	dB(A)
L <sub>WA</sub> Outlet	73	52	60	64	63	66	67	65	55	dB(A)
L <sub>WA</sub> Emitted	54	18	25	43	47	47	50	46	34	dB(A)

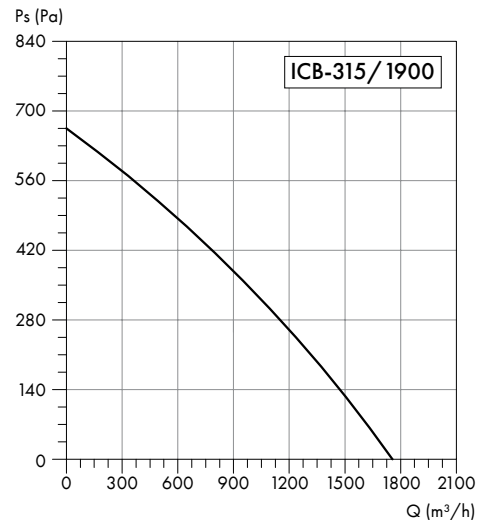

Frequency	Total	63	125	250	500	1000	2000	4000	8000	Hz
L <sub>WA</sub> Inlet	75	55	66	68	70	68	66	63	58	dB(A)
L <sub>WA</sub> Outlet	76	62	67	71	69	68	69	63	57	dB(A)
L <sub>WA</sub> Emitted	56	22	35	45	51	47	50	46	45	dB(A)

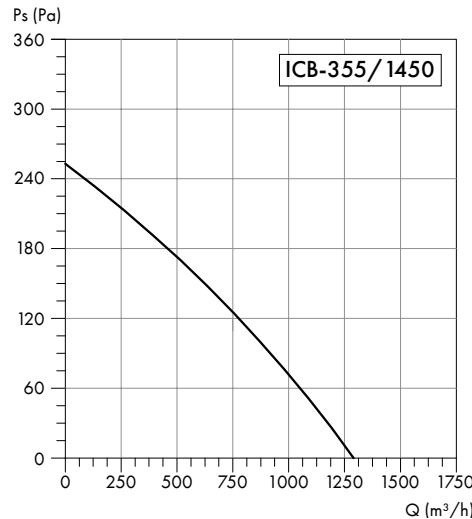

Frequency	Total	63	125	250	500	1000	2000	4000	8000	Hz
L <sub>WA</sub> Inlet	70	49	59	65	61	64	61	60	50	dB(A)
L <sub>WA</sub> Outlet	71	48	60	65	61	65	63	61	51	dB(A)
L <sub>WA</sub> Emitted	52	27	28	46	45	47	45	42	30	dB(A)



## Duct fans ICM



High pressure



Two-speed motor



IP 45 protection class



Easy installation

### Design

Duct fan, diagonal. Its unique design allows it to achieve high operating parameters with relatively low noise and low energy consumption. The fan cover is made of polypropylene, while the rotor is made of ABS plastic. Special connectors make it easy to install, remove and maintain the appliance. The device can be installed both horizontally and vertically.

### Usage

The ICM fan is designed to transport clean air. It is ideal for the installation of air-supply and exhaust in residential buildings, public utility buildings, offices, shops. The device can also be used for the installation of fume hoods from kitchen hoods that require the use of grease filters.

### Electric motor

**Two-speed motor**, powered by single-phase current 230V, 50Hz. Suitable for voltage regulation. Protection class IP 44, insulation class B. The motor is equipped with durable ball bearings and thermal protection of the winding against overload.

### Operating temperature

The fan is designed to transmit air with a temperature not exceeding 60°C.



Dynamically balanced diagonal rotor



Sealed connection box located on the cover



Special profiled guides located behind the rotor ensure higher efficiency



Stable mounting base for the fan

### Technical specifications

Model	Speed	Air flow [m <sup>3</sup> /h]	Impeller speed [rpm]	Power [W]	Current [A]	Voltage [V]	Frequency [Hz]	Sound pressure level [dB(A)]	Weight [kg]	Switch HRS	Controller HRX	Controller HRB
ICM-100/200M	HS	198	2200	26	0,12	230	50	31	2,0	Yes	1,0	1,5
	LS	165	1850	23	0,11			26				
ICM-125/290M	HS	284	2250	33	0,14	230	50	31	1,8	Yes	1,0	1,5
	LS	248	1850	28	0,13			26				
ICM-150-160/530M	HS	530	2550	54	0,24	230	50	33	2,7	Yes	1,0	1,5
	LS	410	1850	48	0,21			29				
ICM-200/840M	HS	840	2450	128	0,57	230	50	63	4,9	Yes	1,0	1,5
	LS	690	1950	123	0,52			55				
ICM-250/1410M	HS	1405	2450	225	1,20	230	50	66	7,5	Yes	2,5	1,5
	LS	1064	1950	165	0,75			58				
ICM-315/2210M	HS	2206	2350	390	1,90	230	50	69	11,3	Yes	2,5	3,0
	LS	1750	1650	275	1,40			61				

Sound pressure level measured at 3m.

### Technical drawing

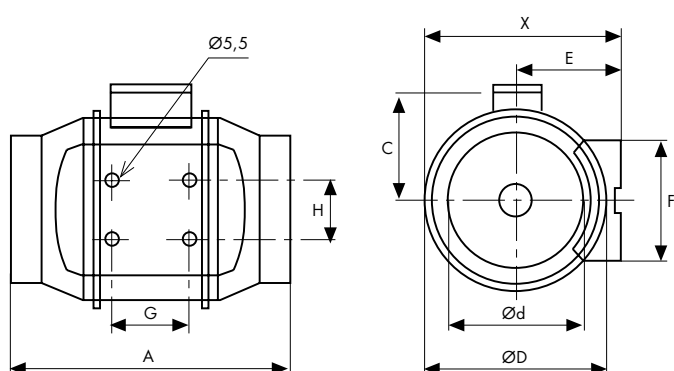

### Dimensions [mm]

Model	X	A	ØD	C	Ød	E	F	G	H
ICM-100/200M	188	303	176	115	97	100	90	80	60
ICM-125/290M	188	258	176	115	123	100	90	80	60
ICM-150-160/530M	212	320	200	127	147/158	112	130	80	60
ICM-200/840M	232	302	217	141	197	124	140	100	94
ICM-250/1410M	286	383	258	173	247	151	195	150	173
ICM-315/2210M	357	446	324	216	312	187	220	181	216

## Characteristics

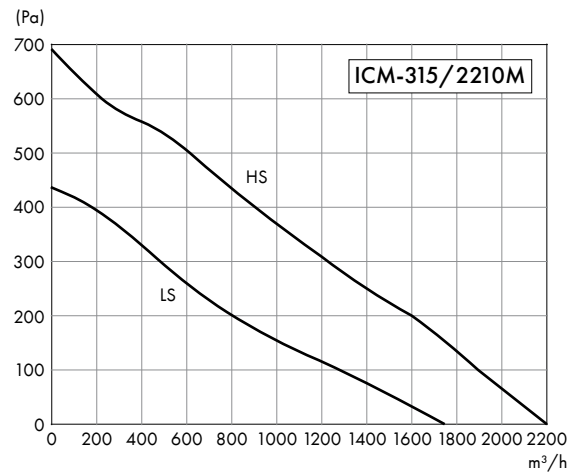
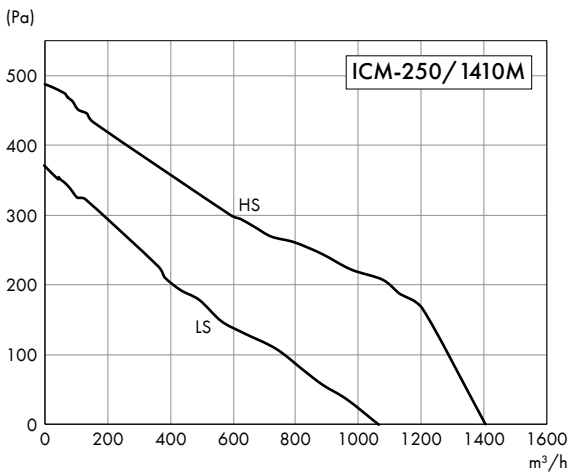
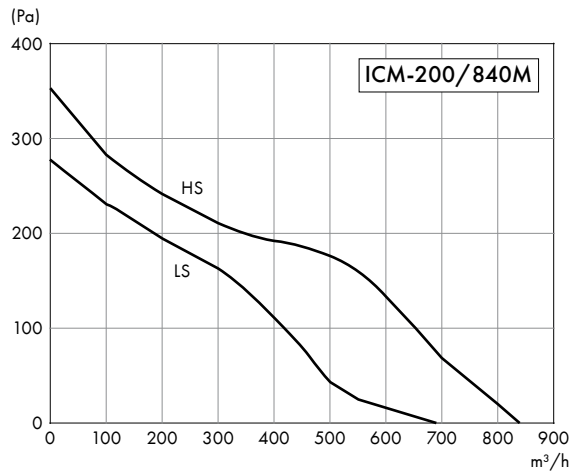
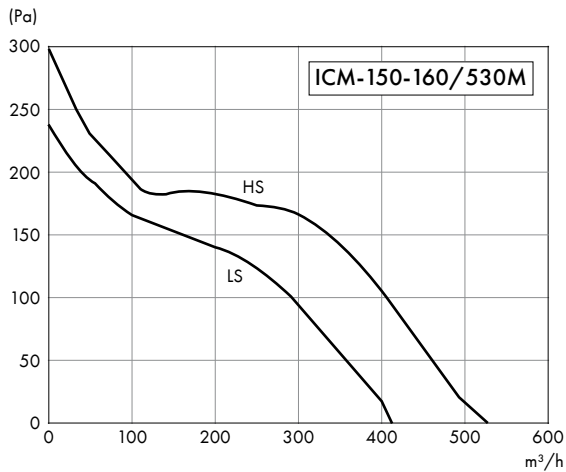
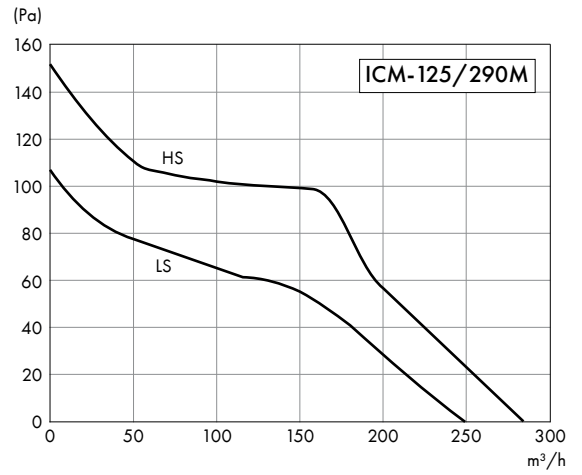
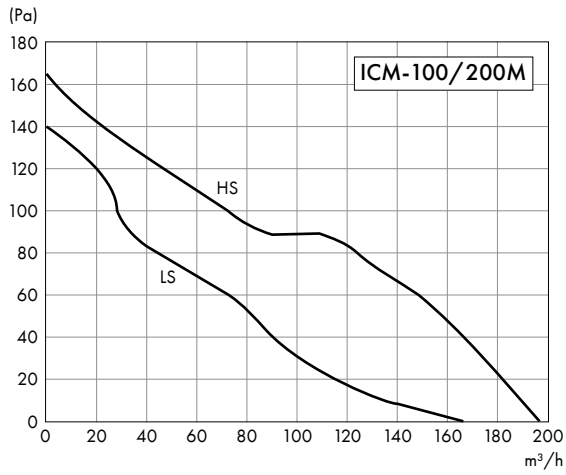

## Accessories



### HRS

Single-phase motor gear switch  
page 175



### HRB

Transformer speed controller  
page 176



### PSH

Pressure switch  
page 173



### PCC

Fastening clamp  
page 81



### HRX

Electronic speed controller  
page 174



### FKOV

Filter G3 for round ducts  
page 83



### AKUFLEX

Flexible acoustic silencer  
page 71



### RSKV

Backdraft damper  
page 41



### WSH

Service switch  
page 177

# Duct fans ICM EC



High efficiency motor



IP 44 protection class



Easy installation



Controller 0-10 V

## Design

Duct fan, diagonal. Its unique design and the use of the most modern electronically commutated (EC motor) allows it to achieve high operating parameters with relatively low noise and very low energy consumption. The fan cover is made of polypropylene, while the rotor is made of ABS plastic. Special connectors make it easy to install, remove and maintain the appliance. The device can be installed both horizontally and vertically.

## Usage

The ICM-EC fan is designed to transport clean air. It is ideal for the installation of air-supply and exhaust in residential buildings, public utility buildings, offices, shops. The device can also be used for the installation of fume hoods from kitchen hoods that require the use of grease filters.

## Electric motor

**High efficiency electronically commutated direct current motor (EC).** Power supply 230V ~1, 50Hz. The engines are designed for smooth full range speed regulation while maintaining high efficiency. The speed control is realized by means of a controller using an analogue signal 0-10V. Protection class IP44.

## Operating temperature

The fan is designed to transmit air with a temperature not exceeding 60°C.



Dynamically balanced diagonal rotor



Sealed connection box located on the cover



Special profiled guides located behind the rotor ensure higher efficiency



Stable mounting base for the fan

## Technical specifications

Model	Air flow [m³/h]	Impeller speed [rpm]	Power [W]	Current [A]	Voltage [V]	Frequency [Hz]	Sound pressure level [dB(A)]	Weight [kg]	Controller HMTF	Controller RS-EC
ICM-EC-100/366M	366	3800	70	0,47	230	50	35	1,8	Yes	Yes
ICM-EC-125/561M	561	3800	70	0,47	230	50	35	2	Yes	Yes
ICM-EC-150-160/647M	647	3000	70	0,47	230	50	43	2,7	Yes	Yes
ICM-EC-200/1250M	1250	3000	180	1,05	230	50	50	4,9	Yes	Yes
ICM-EC-250/1652M	1652	3000	255	1,5	230	50	65	7,9	Yes	Yes
ICM-EC-315/2206M	2206	2350	250	1,4	230	50	68	11,3	Yes	Yes

Sound pressure level measured at 3m.

## Technical drawing

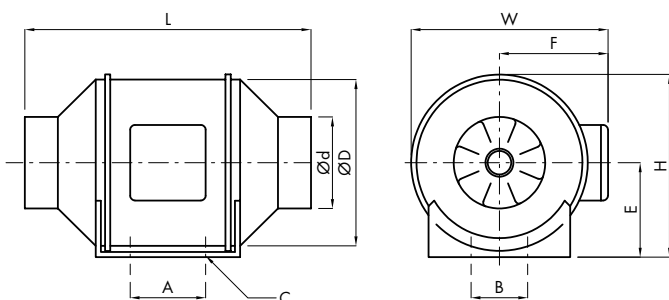

## Dimensions [mm]

Model	A	B	ØC	Ød	E	F	ØD	L	W	H
ICM-EC-100/366M	80	60	4 - 4,5	97	99	116	163	302	204	195
ICM-EC-125/561M	80	60	4 - 4,5	123	99	116	163	257	204	195
ICM-EC-150-160/647M	80	60	4 - 5,0	147	109	127	187	313	227	208
ICM-EC-200/1250M	100	94	4 - 5,5	197	125	137	205	302	249	237
ICM-EC-250/1652M	150	150	4 - 8*11	247	150	174	261	383	310	286
ICM-EC-315/2206M	181	178	4 - 8*11	312	187	216	325	446	386	357

## Characteristics

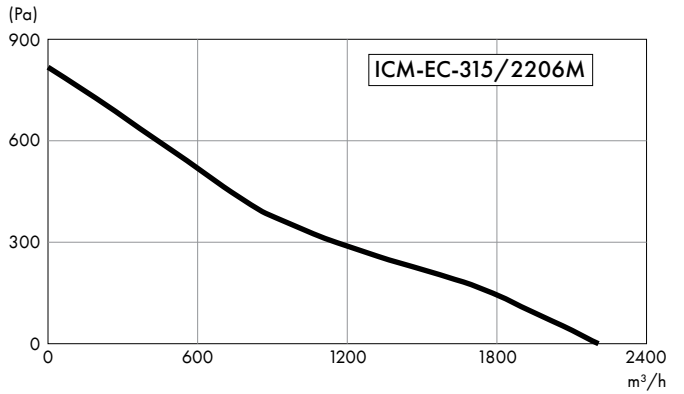
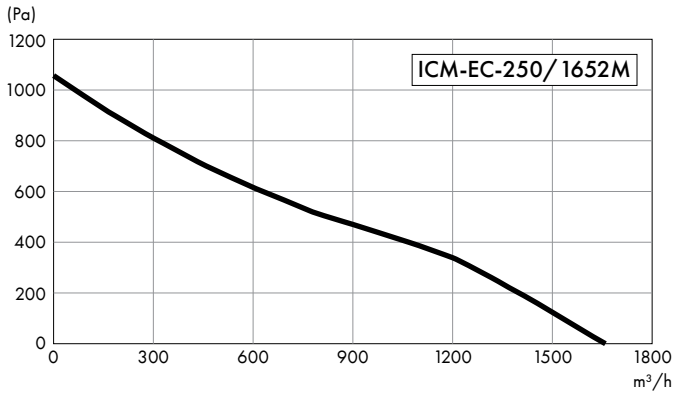
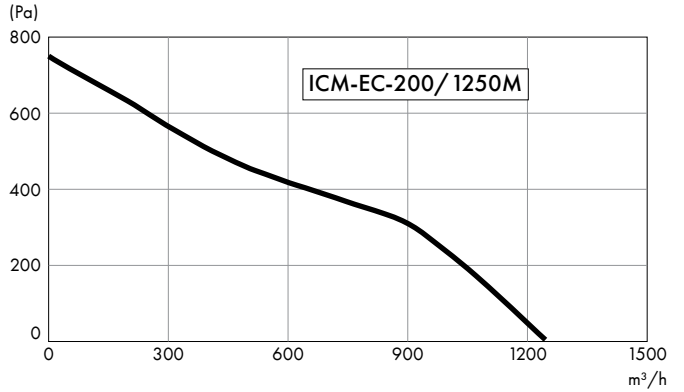
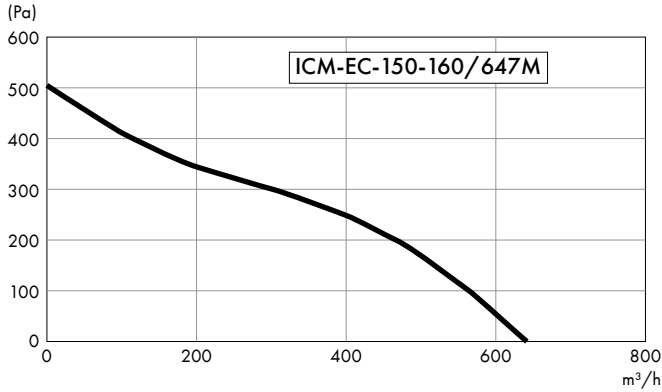
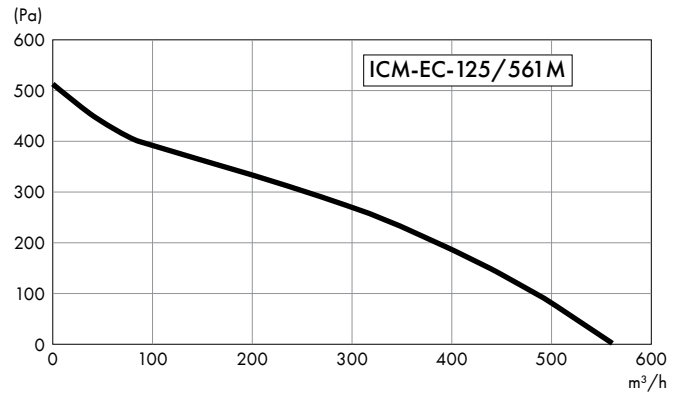
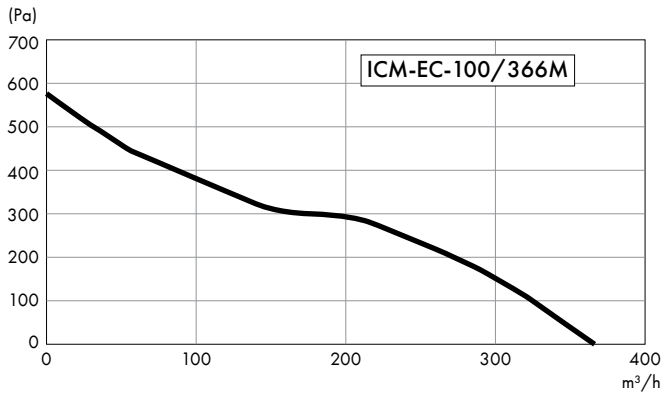

## Accessories



**HMTP**  
Potentiometer for EC motors  
page 175



**FKOV**  
Filter G3 for round ducts  
page 83



**AKUFLEX**  
Flexible acoustic silencer  
page 71



**RSKV**  
Backdraft damper  
page 41



**RS-EC**  
Speed controller for EC motors  
page 175



**WSH**  
Service switch  
page 177



**PCC**  
Fastening clamp  
page 81



**PSH**  
Pressure switch  
page 173



## Duct fans ICMsilent



Exceptionally quiet operation



High pressure



Two-speed

### Design

Duct fan, diagonal. Its unique design ensures low noise emissions by using a perforated interior cover and a double layer of sound-absorbing material. The fan cover is made of polypropylene, while the rotor is made of ABS plastic. The unit is equipped with an integrated return damper. Special connectors make it easy to install, remove and maintain the appliance. The fan can be installed both horizontally and vertically.

### Usage

The ICMsilent fan is designed to transport clean air. Ideal for installation of general ventilation of public buildings, conference rooms, offices, restaurants, hotels, school rooms.

### Electric motor

Two-speed motor, powered by single-phase current 230V, 50Hz. Suitable for voltage regulation. Protection class IP 44, insulation class B. The motor is equipped with durable ball bearings and thermal protection of the winding against overload.

### Operating temperature

The fan is designed to transmit air with a temperature not exceeding 60°C.



Dynamically balanced diagonal rotor

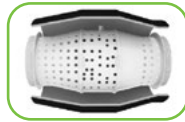

Original cover design - using perforated interior and double-layer sound-absorbing material



Special connectors facilitate device installation



Integrated return damper

### Technical specifications

Model	Speed	Air flow [m³/h]	Impeller speed [rpm]	Power [W]	Current [A]	Voltage [V]	Frequency [Hz]	Sound pressure level [dB(A)]	Weight [kg]	Switch HRS	Controller HRX	Controller HRB
ICMsilent-100-125/290M	HS	284	2250	33	0,14	230	50	29	2,8	Yes	1,0	1,5
	LS	248	1850	28	0,13			24				
ICMsilent-150-160/530M	HS	530	2550	50	0,25	230	50	31	4,0	Yes	1,0	1,5
	LS	410	1850	43	0,20			26				
ICMsilent-200/840M	HS	840	2550	128	0,57	230	50	37	4,5	Yes	1,0	1,5
	LS	690	1950	123	0,52			32				

Sound pressure level measured at 3m.

### Technical drawing

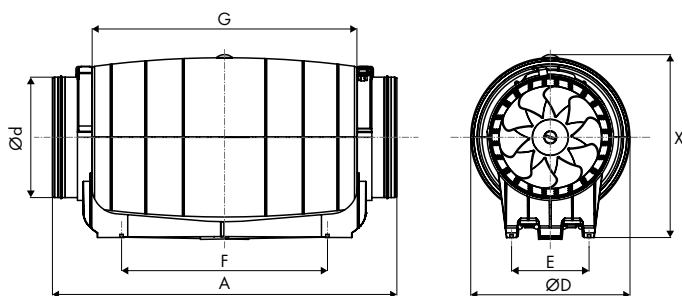

### Dimensions [mm]

Model	X	A	ØD	Ød	E	F	G
ICMsilent-100-125/290M	225	580/462	204	97/123	82	248	330
ICMsilent-150-160/530M	244	488	221	148/158	95	251	352
ICMsilent-200/840M	301	567	262	198	128	339	436

## Characteristics

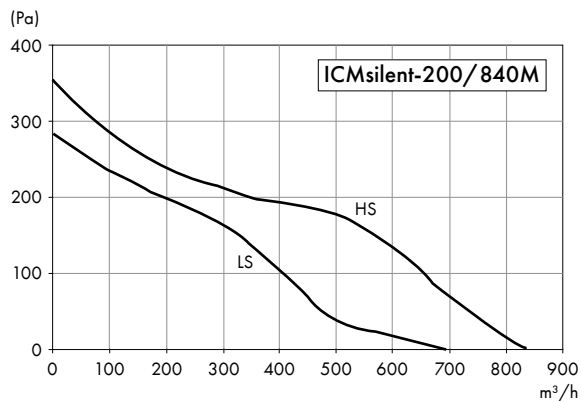
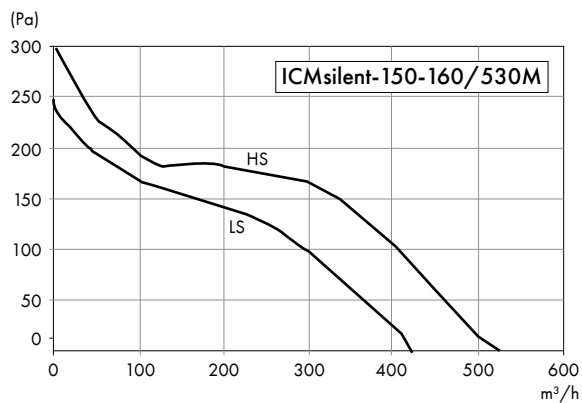
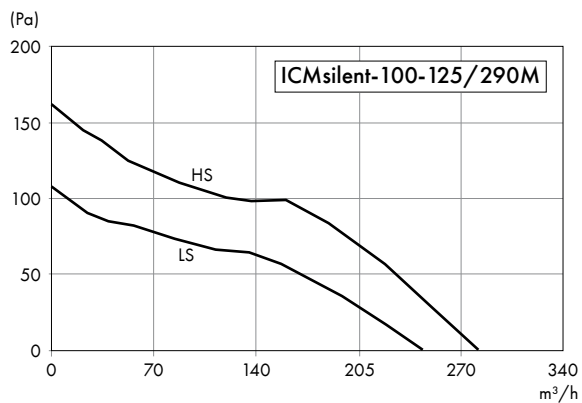

## Accessories



### HRS

Single-phase motor gear switch  
page 175



### HRB

Transformer speed controller  
page 176



### PSH

Pressure switch  
page 173



### PCC

Fastening clamp  
page 81



### HRX

Electronic speed controller  
page 174



### FKOV

Filter G3 for round ducts  
page 83



### AKUFLEX

Flexible acoustic silencer  
page 71



### WSH

Service switch  
page 177



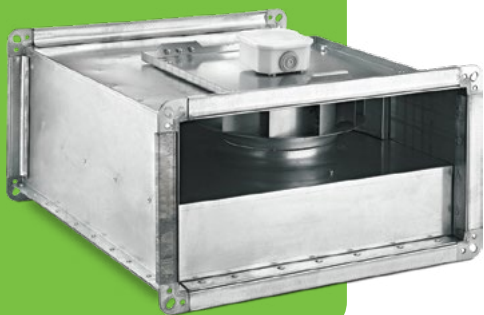

## Rectangular duct fans IRB



Supply and exhaust installations



IP 44 protection class



Made of galvanized steel

### Design

Radial fan, suitable for installation in rectangular ducts. The cover and rotor with backward curved impeller are made of galvanized sheet. The motor mounted directly to the inspection door allows easy disassembly and the service of the device. The junction box is attached directly to the cover.

### Usage

The IRB fan is ideal for supply and exhaust installations in residential construction, as well as in many commercial facilities, such as: cafes, bars, restaurants, schools, gyms, warehouses, as well as in supply industrial installations.

### Technical specifications

Model	Air flow [m <sup>3</sup> /h]	Impeller speed [rpm]	Power [W]	Current [A]	Voltage [V]	Frequency [Hz]	Capacitor [µF]	Sound pressure level [dB(A)]	Weight [kg]	Controller HRX	Controller HRB	Frequency converter
IRB-4020/940 M	950	2650	100	0,49	230	50	4	48	10,5	1,0	1,5	-
IRB-4020/1200 M	1150	2650	130	0,64	230	50	5	54	11	1,0	1,5	-
IRB-5025/1800 M	1610	2600	180	0,82	230	50	6	58	15	2,5	1,5	-
IRB-6030/2000 M	1850	1440	160	0,9	230	50	6	50	29	1,0	1,5	-
IRB-6035/2800 M	2500	1440	140	0,86	230	50	6	53	31	1,0	1,5	-
IRB-6035/3400 M	3300	1400	200	1,0	230	50	8	53	32	2,5	1,5	-
IRB-7040/4500 M	4000	1350	310	1,55	230	50	10	56	44	4,0	3,0	-
IRB-7040/5900 M	5400	1350	500	2,5	230	50	10	58	46	4,0	4,0	-
IRB-8050/8000 T	7550	1335	960	2,0	400 Δ/Y	50	-	64	66	-	-	Yes
IRB-10050/10000 T	9600	1250	1400	2,7	400 Δ/Y	50	-	66	84	-	-	Yes

Sound pressure level measured at 3m.

### Electric motor

Motor with rotating stator, powered by single phase current 230V, 50Hz. Suitable for voltage regulation or three phase with frequency inverter. Protection class IP 44, insulation class B or F.

### Operating temperature

The fan is designed to transmit air with a temperature not exceeding 45°C.

### Technical drawing

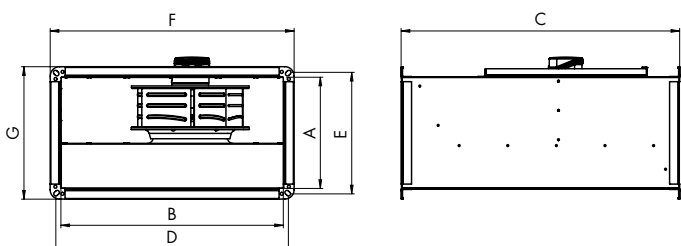

### Dimensions [mm]

Model	A	B	C	D	E	F	G
IRB-3015/520 M	150	300	400	320	170	350	200
IRB-4020/940 M	200	400	500	420	220	450	250
IRB-4020/1200 M	200	400	500	420	220	450	250
IRB-5025/1800 M	250	500	565	520	270	550	300
IRB-6030/2000 M	300	600	650	620	320	650	350
IRB-6035/2800 M	350	600	750	620	370	650	400
IRB-6035/3400 M	350	600	760	620	370	650	400
IRB-7040/4500 M	400	700	800	720	420	750	450
IRB-7040/5900 M	400	700	800	720	420	750	450
IRB-8050/8000 T	500	800	9120	820	520	850	560
IRB-10050/10000 T	500	1000	1050	1030	530	1060	560

### Accessories



**HRX**  
Electronic speed controller  
page 174



**REC**  
Anti-vibration connectors for fans with rectangular connection  
page 81



**PSH**  
Pressure switch  
page 173



**WSH**  
Service switch  
page 177



**HRB**  
Transformer speed controller  
page 176



**RDA**  
Rectangular duct silencer  
page 82

# Characteristics

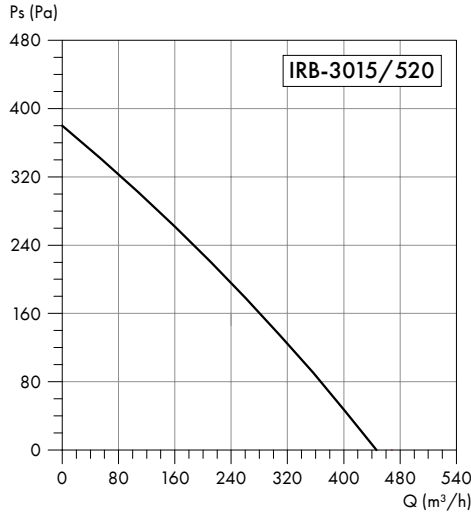

Frequency	Total	63	125	250	500	1000	2000	4000	8000	Hz
L <sub>wA</sub> Inlet	66	44	56	64	56	55	53	47	38	dB(A)
L <sub>wA</sub> Outlet	69	48	53	66	63	61	58	51	43	dB(A)
L <sub>wA</sub> Emitted	50	26	33	47	44	42	41	35	27	dB(A)

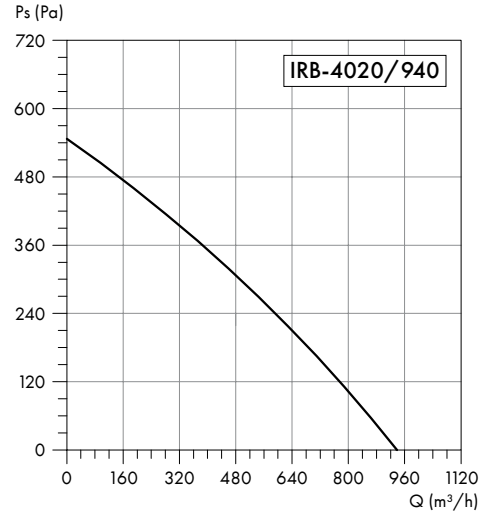

Frequency	Total	63	125	250	500	1000	2000	4000	8000	Hz
L <sub>wA</sub> Inlet	69	44	54	66	58	61	59	55	47	dB(A)
L <sub>wA</sub> Outlet	72	44	53	67	64	63	66	61	58	dB(A)
L <sub>wA</sub> Emitted	55	20	34	53	45	44	44	38	35	dB(A)

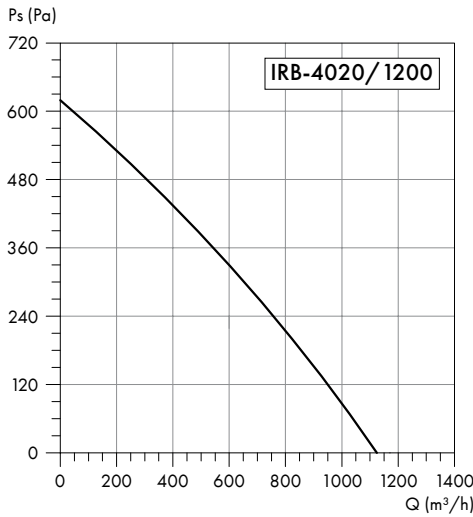

Frequency	Total	63	125	250	500	1000	2000	4000	8000	Hz
L <sub>wA</sub> Inlet	74	50	61	69	63	67	65	63	60	dB(A)
L <sub>wA</sub> Outlet	78	51	61	70	69	70	73	67	69	dB(A)
L <sub>wA</sub> Emitted	61	31	35	55	54	54	55	47	45	dB(A)

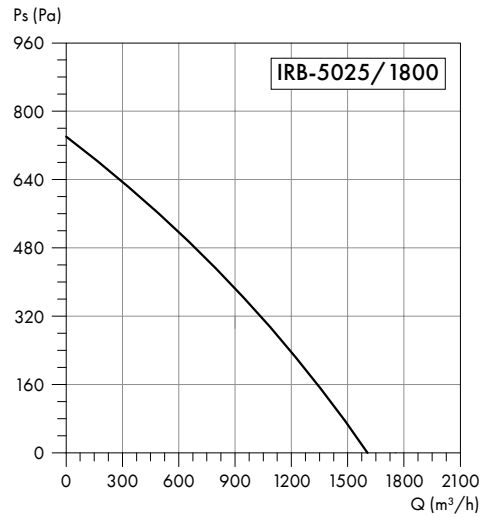

Frequency	Total	63	125	250	500	1000	2000	4000	8000	Hz
L <sub>wA</sub> Inlet	74	50	61	67	65	68	66	63	60	dB(A)
L <sub>wA</sub> Outlet	78	51	61	69	71	71	73	67	70	dB(A)
L <sub>wA</sub> Emitted	65	33	40	59	57	59	58	50	47	dB(A)

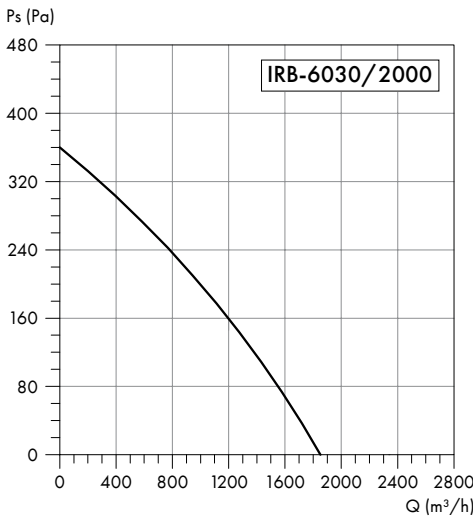

Frequency	Total	63	125	250	500	1000	2000	4000	8000	Hz
L <sub>wA</sub> Inlet	69	50	62	64	61	62	57	52	44	dB(A)
L <sub>wA</sub> Outlet	72	49	60	65	68	65	63	58	46	dB(A)
L <sub>wA</sub> Emitted	57	35	47	54	52	47	44	39	32	dB(A)

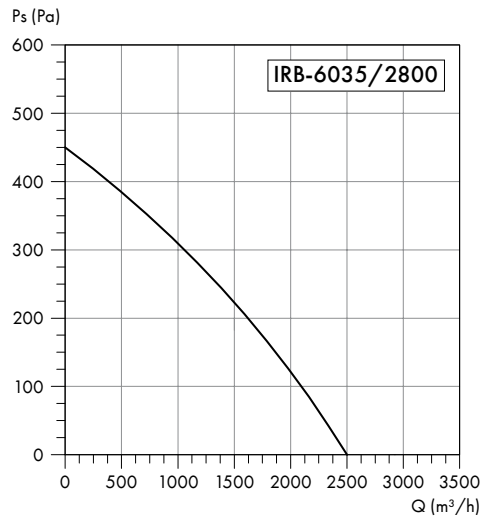

Frequency	Total	63	125	250	500	1000	2000	4000	8000	Hz
L <sub>wA</sub> Inlet	70	50	65	61	63	60	61	56	48	dB(A)
L <sub>wA</sub> Outlet	76	54	72	68	69	68	67	62	54	dB(A)
L <sub>wA</sub> Emitted	60	27	57	53	50	49	48	49	37	dB(A)

## Characteristics

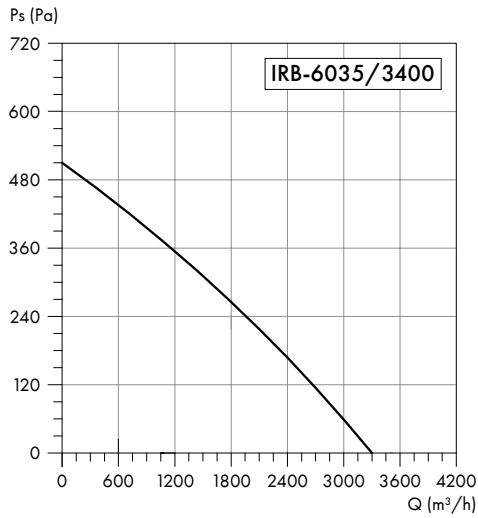

Frequency	Total	63	125	250	500	1000	2000	4000	8000	Hz
$L_{wa}$ Inlet	75	60	70	66	68	66	65	62	53	dB(A)
$L_{wa}$ Outlet	80	60	71	72	74	73	71	67	58	dB(A)
$L_{wa}$ Emitted	65	41	63	59	54	53	48	41	35	dB(A)

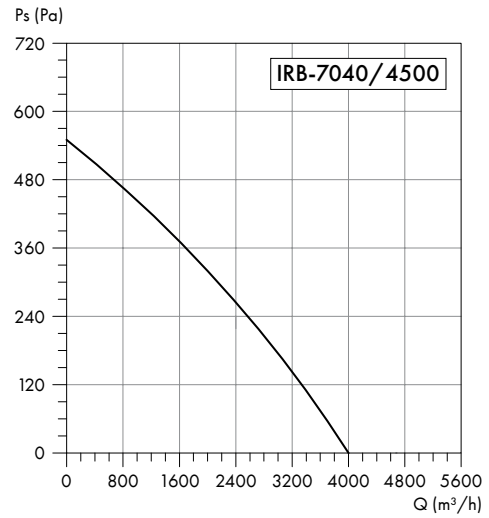

Frequency	Total	63	125	250	500	1000	2000	4000	8000	Hz
$L_{wa}$ Inlet	73	58	68	64	66	66	62	56	50	dB(A)
$L_{wa}$ Outlet	77	62	68	70	71	71	69	61	55	dB(A)
$L_{wa}$ Emitted	63	40	60	57	52	51	46	38	35	dB(A)

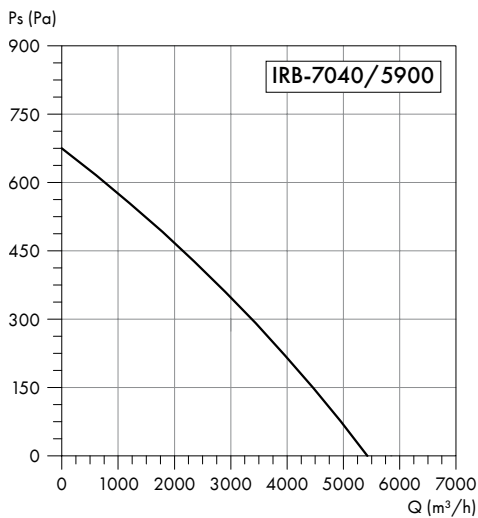

Frequency	Total	63	125	250	500	1000	2000	4000	8000	Hz
$L_{wa}$ Inlet	75	60	70	68	69	66	66	62	52	dB(A)
$L_{wa}$ Outlet	79	60	71	71	73	74	71	38	55	dB(A)
$L_{wa}$ Emitted	65	41	62	58	56	56	49	42	36	dB(A)

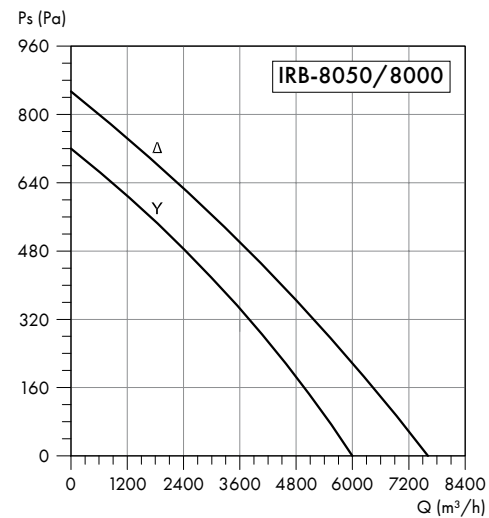

Frequency	Total	63	125	250	500	1000	2000	4000	8000	Hz
$L_{wa}$ Inlet	79	61	72	71	73	71	71	66	58	dB(A)
$L_{wa}$ Outlet	84	66	75	76	77	79	75	70	61	dB(A)
$L_{wa}$ Emitted	71	45	68	64	61	61	60	54	43	dB(A)

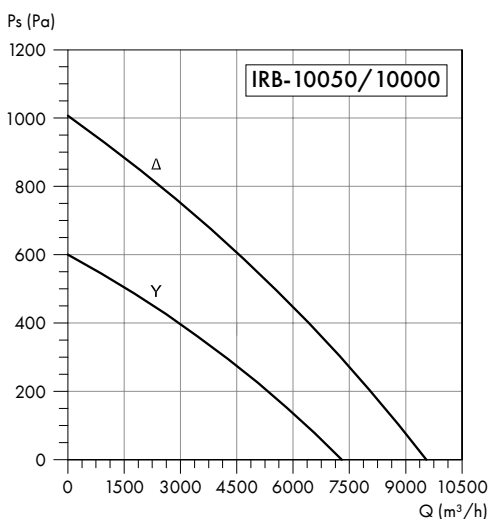

Frequency	Total	63	125	250	500	1000	2000	4000	8000	Hz
$L_{wa}$ Inlet	84	70	77	76	78	78	75	71	65	dB(A)
$L_{wa}$ Outlet	89	71	80	81	82	83	80	74	65	dB(A)
$L_{wa}$ Emitted	72	58	69	64	62	60	56	52	50	dB(A)



## Kitchen fans IKB



120°C



Easy maintenance



Easy clean

### Design

Direct drive radial fan. Cover made of galvanised sheet, soundproof and thermally insulated with mineral wool with a thickness of 50 mm. Rotor with blades tilted backwards, made of galvanised sheet. The housing has a tilting inspection hatch, allowing for convenient maintenance and cleaning of the fan.

### Usage

The IKB fans are designed for both domestic and commercial kitchen drafts: bars, canteens, pubs, restaurants, schools, hospitals.

### Electric motor

Asynchronous single-phase 230V, 50Hz, without the possibility of changing the rotation speed, or three-phase 400V, 50Hz, adapted to adjust the frequency converter. Protection class IP 55, insulation class F.

### Operating temperature

The fan is designed to transmit air with a temperature not exceeding 120°C.

### Technical specifications

Model	Air flow [m³/h]	Impeller speed [rpm]	Power [W]	Current [A]	Voltage [V]	Frequency [Hz]	Sound pressure level [dB(A)]	Weight [kg]
IKB-315/2300 M	1800	1390	250	2,1	230	50	37-29	51
IKB-355/3800 M	2800	1390	250	2,1	230	50	41-33	63
IKB-400/4500 M	4000	1400	370	3,4	230	50	42-34	78
IKB-450/5600 M	5200	1410	550	4,5	230	50	45-37	87
IKB-315/2300 T	1800	1380	250	0,87	400	50	37-29	51
IKB-355/3800 T	2800	1380	250	0,87	400	50	41-33	63
IKB-400/4500 T	4000	1390	370	1,2	400	50	42-34	78
IKB-450/5600 T	5200	1365	550	1,6	400	50	45-37	87

Sound pressure level measured outdoor at 4 and 10 m.

### Technical drawing

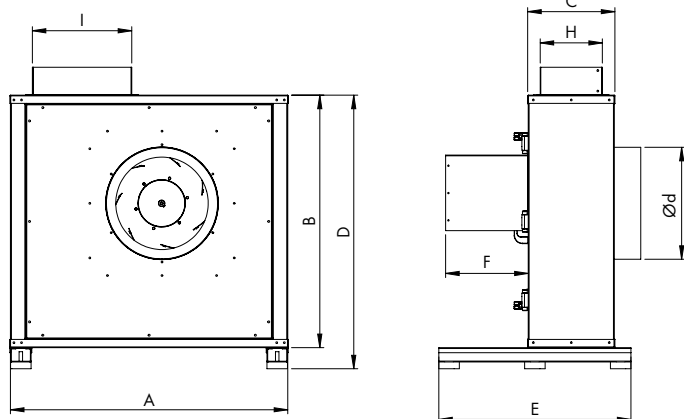

### Dimensions [mm]

Model	A	B	C	D	E	F	Ød	H	I
IKB-315	650	605	220	665	480	245	250	160	230
IKB-355	730	655	230	715	480	245	280	170	260
IKB-400	815	740	255	800	580	245	330	185	295
IKB-450	905	810	270	870	580	245	350	210	325

## Characteristics

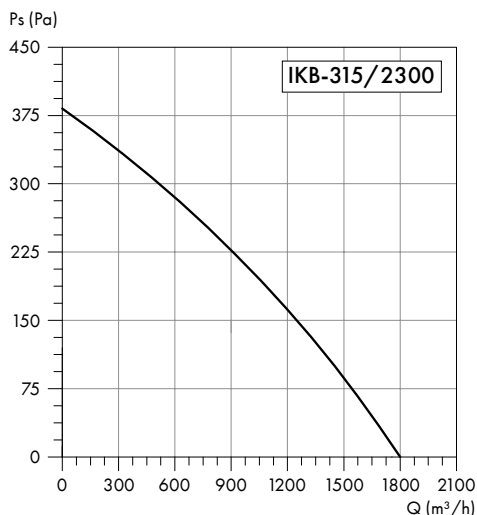

Frequency	Total	63	125	250	500	1000	2000	4000	8000	Hz
$L_{wa}$ Inlet	78	-	74	73	68	66	62	56	53	dB(A)
$L_{wa}$ Outlet	80	-	76	75	70	67	64	58	55	dB(A)
$L_{wa}$ Emitted	60	-	56	55	50	48	44	38	35	dB(A)

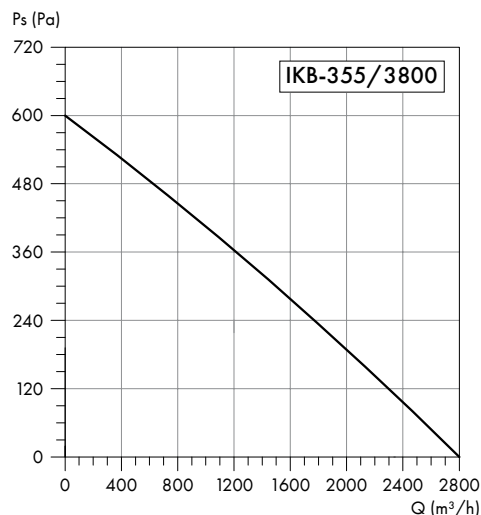

Frequency	Total	63	125	250	500	1000	2000	4000	8000	Hz
$L_{wa}$ Inlet	82	-	78	77	72	70	66	60	57	dB(A)
$L_{wa}$ Outlet	84	-	80	79	74	72	68	62	59	dB(A)
$L_{wa}$ Emitted	64	-	60	59	54	52	48	42	39	dB(A)

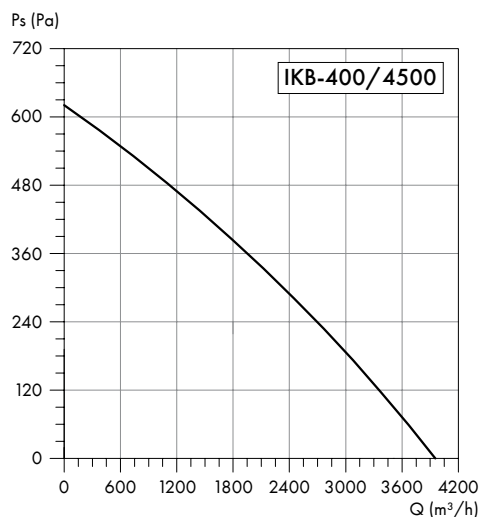

Frequency	Total	63	125	250	500	1000	2000	4000	8000	Hz
$L_{wa}$ Inlet	83	-	79	78	73	71	67	61	58	dB(A)
$L_{wa}$ Outlet	85	-	81	80	75	73	69	63	60	dB(A)
$L_{wa}$ Emitted	65	-	61	60	55	53	49	43	40	dB(A)

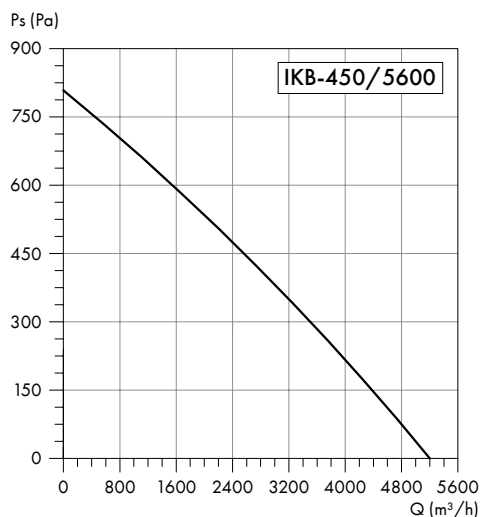

Frequency	Total	63	125	250	500	1000	2000	4000	8000	Hz
$L_{wa}$ Inlet	86	-	82	81	76	74	70	64	61	dB(A)
$L_{wa}$ Outlet	88	-	84	83	78	76	75	66	63	dB(A)
$L_{wa}$ Emitted	68	-	64	63	58	56	52	46	43	dB(A)

## Accessories



**FKOV**  
Filter G3 for round ducts  
page 83



**PCC**  
Fastening clamp  
page 81



**RSKV**  
Backdraft damper  
page 41



**WSH**  
Service switch  
page 177



**PSH**  
Pressure switch  
page 173

## Roof fans RBH



Lacquered  
cover



Exhaust  
fan



Horizontal  
position

### Design

Roof fan, radial, with horizontal air exhaust. Cover made of steel sheet, powder coated in colour RAL 7030. Rotor with backward curved impeller, made of galvanised sheet, dynamically balanced.

### Usage

The quiet and reliable operation of the fan makes it ideal for extraction installations both from residential and commercial buildings, such as apartments, offices, shops, warehouses.

### Electric motor

Motor with rotating stator, powered by single-phase current 230V, 50Hz or three-phase 400V, 50Hz. Suitable for voltage regulation or frequency converter (3 phase products). Protection class IP 44, insulation class B or F.

### Operating temperature

The fan is designed to transmit air with a temperature not exceeding 50°C.

### Technical specifications

Model	Air flow [m <sup>3</sup> /h]	Impeller speed [rpm]	Power [W]	Current [A]	Voltage [V]	Frequency [Hz]	Capacitor [µF]	Sound pressure level [dB(A)]	Weight [kg]	Controller HRX	Controller HRB	Frequency converter	Inlet flange
RBH-160/240 M	346	2600	60	0,3	230	50	2,0	44-36	4,0	1,0	1,5	-	ILB 160
RBH-180/380 M	460	2500	70	0,35	230	50	2,5	49-41	4,5	1,0	1,5	-	ILB 160
RBH-225/850 M	902	2750	80	0,4	230	50	3,0	50-42	7,0	1,0	1,5	-	ILB 200
RBH-250/1300 M	1212	2800	125	0,61	230	50	6,0	52-44	8,0	1,0	1,5	-	ILB 250
RBH-315/1650 M	2000	1450	130	0,8	230	50	6,0	47-39	10,0	1,0	1,5	-	ILB 315
RBH-355/2750 M	2900	1400	200	1,05	230	50	6,0	46-38	16,0	2,5	1,5	-	ILB 315
RBH-400/3600 M	4100	1380	310	1,56	230	50	10	51-43	29,0	2,5	3,0	-	ILB 400
RBH-450/5800 M	5400	1370	430	2,2	230	50	10	52-44	37,0	4,0	4,0	-	ILB 450
RBH-500/8000 T	7600/6150	1360/1100	840/580	1,95/1,12	400 Δ/Y	50	-	54-46	51,0	-	-	Yes	ILB 500
RBH-560/10000 T	9800/7150	1300/950	1440/840	2,8/1,6	400 Δ/Y	50	-	66-58	62,0	-	-	Yes	ILB 560

Sound pressure level measured outdoor at 4 and 10 m.

### Technical drawing

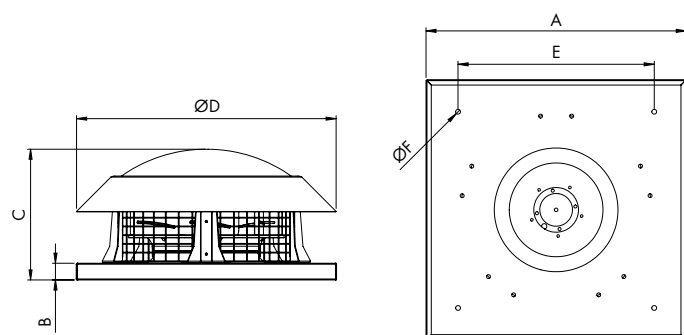

### Dimensions [mm]

Model	A	ØD	C	B	E	F
RBH-160/240 M	252	260	140	25	210	6
RBH-180/380 M	252	260	140	25	210	6
RBH-225/850 M	336	386	212	35	274	11
RBH-250/1300 M	370	386	225	35	290	11
RBH-315/1650 M	454	443	293	40	333	11
RBH-355/2750 M	595	595	285	40	450	11
RBH-400/3600 M	595	685	355	40	450	12
RBH-450/5800 M	664	685	400	40	450	12
RBH-500/8000 T	798	824	385	40	600	12
RBH-560/10000 T	798	824	400	40	600	12

## Characteristics

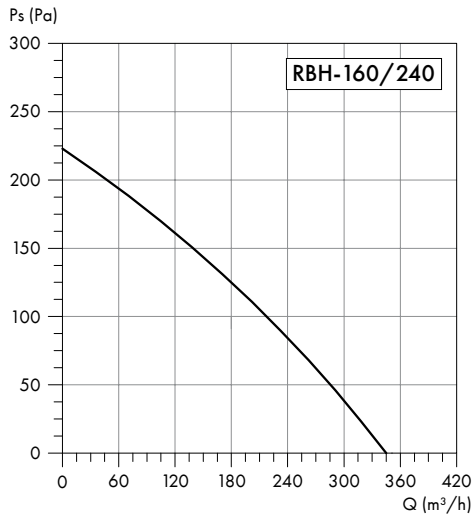

Frequency	Total	63	125	250	500	1000	2000	4000	8000	Hz
$L_{wa}$ Inlet	66	37	55	59	61	60	57	52	45	dB(A)
$L_{wa}$ Emitted	67	38	56	60	62	61	58	53	46	dB(A)

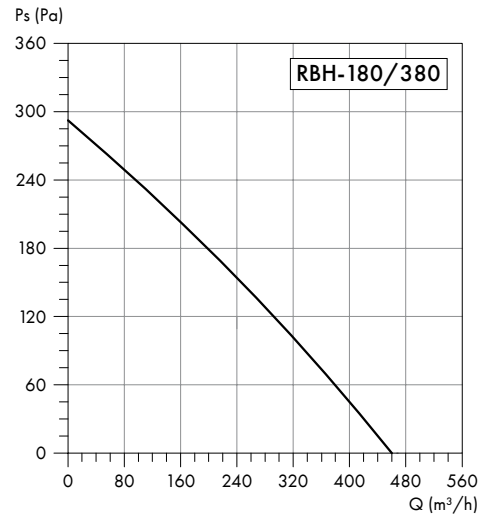

Frequency	Total	63	125	250	500	1000	2000	4000	8000	Hz
$L_{wa}$ Inlet	70	41	59	63	65	64	61	56	49	dB(A)
$L_{wa}$ Emitted	71	42	60	64	66	65	62	57	50	dB(A)

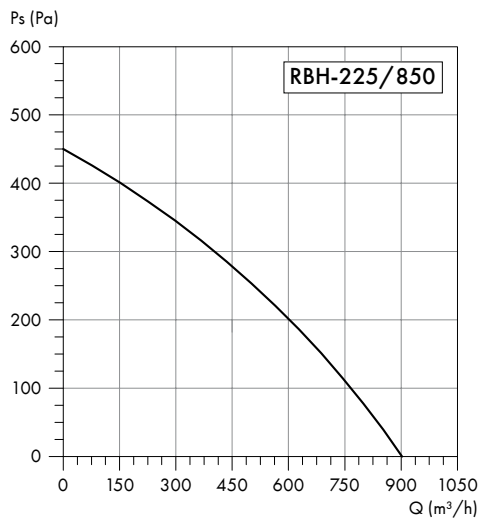

Frequency	Total	63	125	250	500	1000	2000	4000	8000	Hz
$L_{wa}$ Inlet	72	43	61	65	67	66	63	58	51	dB(A)
$L_{wa}$ Emitted	73	44	60	66	68	67	64	59	52	dB(A)

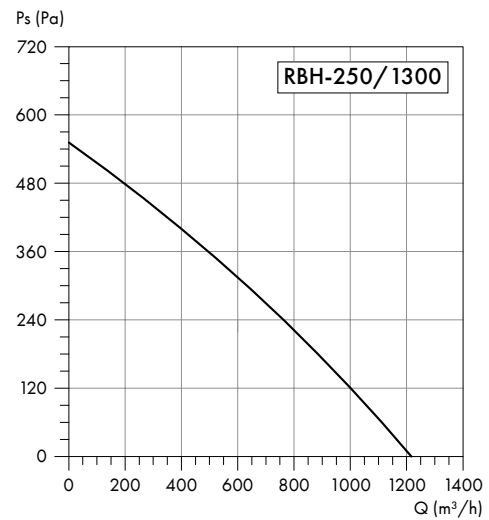

Frequency	Total	63	125	250	500	1000	2000	4000	8000	Hz
$L_{wa}$ Inlet	74	45	63	67	69	68	65	60	53	dB(A)
$L_{wa}$ Emitted	75	46	62	68	70	69	66	61	54	dB(A)

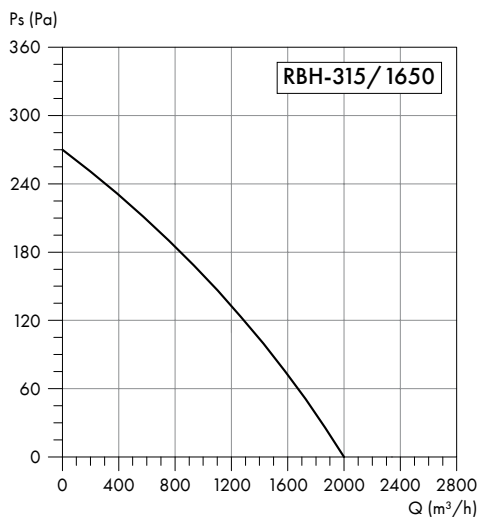

Frequency	Total	63	125	250	500	1000	2000	4000	8000	Hz
$L_{wa}$ Inlet	68	55	57	61	63	62	59	54	47	dB(A)
$L_{wa}$ Emitted	70	57	59	63	65	64	61	56	49	dB(A)

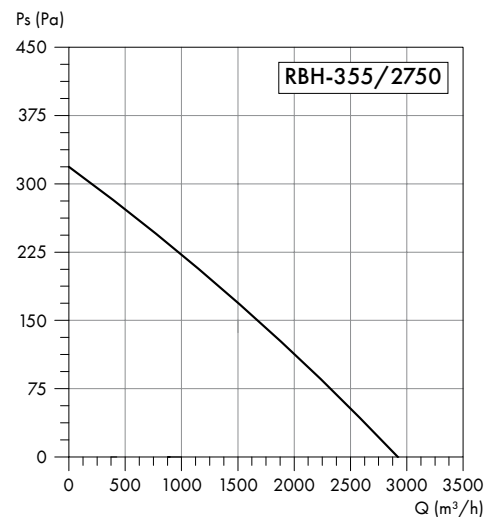

Frequency	Total	63	125	250	500	1000	2000	4000	8000	Hz
$L_{wa}$ Inlet	67	54	56	60	62	61	58	53	46	dB(A)
$L_{wa}$ Emitted	69	56	58	62	64	63	60	55	48	dB(A)



## Characteristics

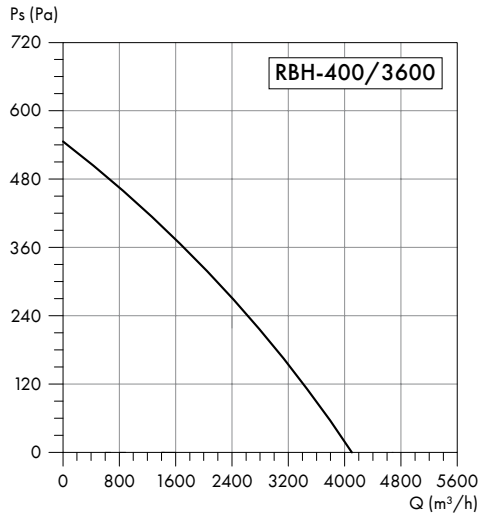

Frequency	Total	63	125	250	500	1000	2000	4000	8000	Hz
L <sub>WA</sub> Inlet	75	43	62	70	65	71	58	54	51	dB(A)
L <sub>WA</sub> Emitted	74	47	67	66	70	68	61	56	52	dB(A)

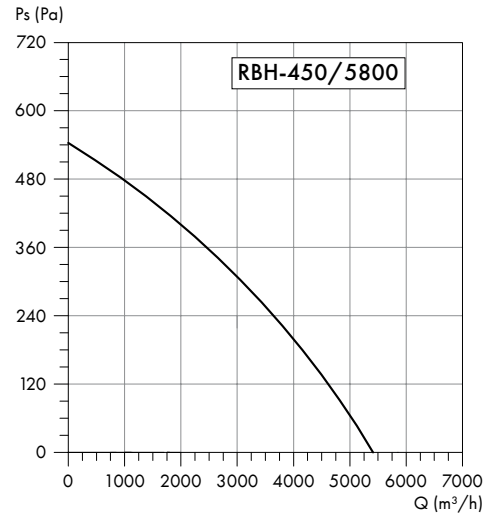

Frequency	Total	63	125	250	500	1000	2000	4000	8000	Hz
L <sub>WA</sub> Inlet	70	43	58	65	64	61	59	54	55	dB(A)
L <sub>WA</sub> Emitted	75	45	64	66	70	69	64	59	57	dB(A)

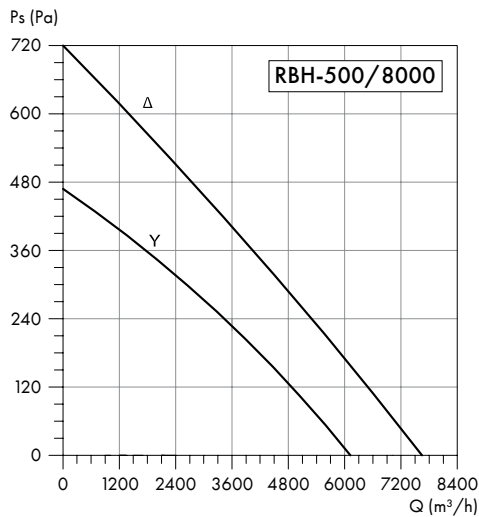

Frequency	Total	63	125	250	500	1000	2000	4000	8000	Hz
L <sub>WA</sub> Inlet	75	48	62	72	70	66	63	58	56	dB(A)
L <sub>WA</sub> Emitted	77	46	64	68	73	70	68	61	57	dB(A)

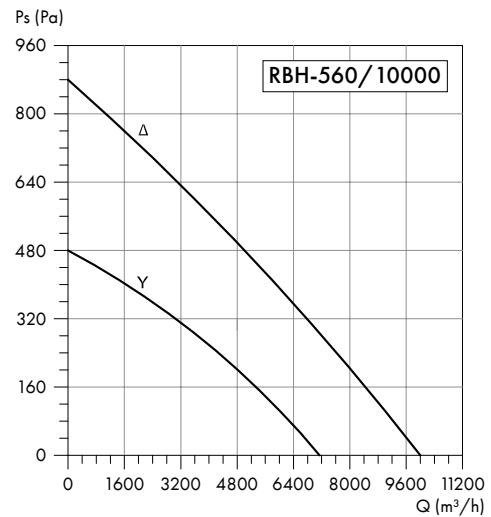

Frequency	Total	63	125	250	500	1000	2000	4000	8000	Hz
L <sub>WA</sub> Inlet	85	58	74	78	80	79	75	70	63	dB(A)
L <sub>WA</sub> Emitted	87	58	75	79	81	82	78	72	65	dB(A)

## Accessories



**HRX**  
Electronic speed controller  
page 174



**FKOV**  
Filter G3 for round ducts  
page 83



**AKUFLEX**  
Flexible acoustic silencer  
page 71



**RSKV**  
Backdraft damper  
page 41



**HRB**  
Transformer speed controller  
page 176



**PSH**  
Pressure switch  
page 173



**PCC**  
Fastening clamp  
page 81



**WSH**  
Service switch  
page 177



## Roof fans RCM



Two-speed motor



Operation in  
exhaust or supply  
mode



Powder-coated  
cover

### Design

Roof fan. Its unique design allows it to achieve high performance with low noise and low energy consumption. The fan is made of high-strength plastic, while the canopy of the device is made of galvanised steel, powder-coated in black. The RCM fan can be operated in either exhaust or air mode. It is prepared for use in exhaust mode. However, the supply mode is achieved by removing the rotor module, turning it 180° and reassembling it with the fan cover.

### Usage

The RCM fan is designed to transport clean air. It is ideally suited for the installation of exhaust and supply residential buildings, offices, shops, and public buildings.

### Electric motor

Two-speed motor powered by single-phase current 230V, 50Hz, equipped with ball bearings. Suitable for voltage regulation. Protection class IP 44, insulation class B. Thermal protection of the winding against overload.

### Operating temperature

The fan is designed to transmit air with a temperature not exceeding 60°C.



Easy to access, tight  
connection box



Built-in connector

### Technical specifications

Model	Speed	Air flow [m <sup>3</sup> /h]	Impeller speed [rpm]	Power [W]	Current [A]	Voltage [V]	Frequency [Hz]	Sound pressure level [dB(A)]	Weight [kg]	Switch HRS	Controller HRX	Controller HRB
RCM-150-160/530M	HS	530	2550	54	0,24	230	50	33	2,7	Yes	1,0	1,5
	LS	410	1850	48	0,21			29				
RCM-200/840M	HS	840	2450	128	0,57	230	50	63	5,1	Yes	1,0	1,5
	LS	690	1950	123	0,52			55				

### Technical drawing

#### RCM-150-160/530M

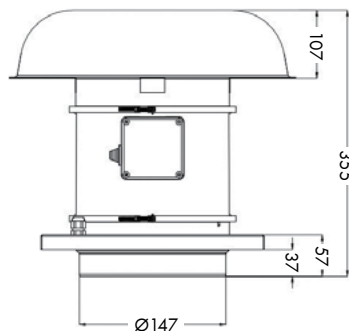

#### RCM-200/840M

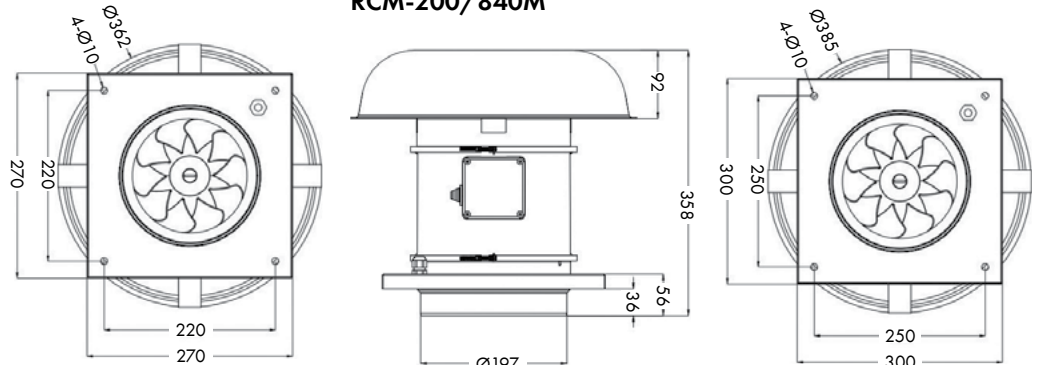

## Characteristics

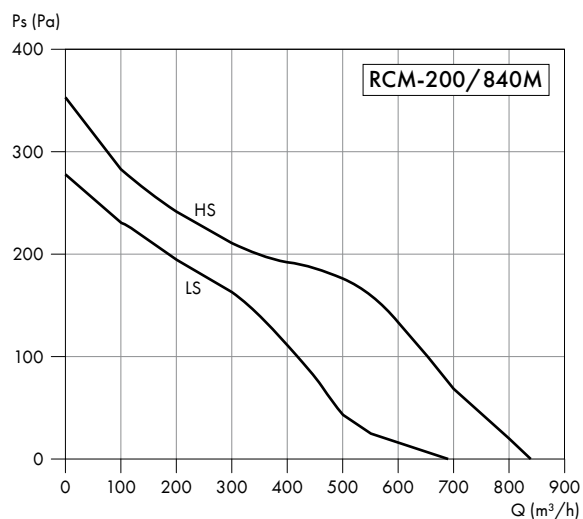
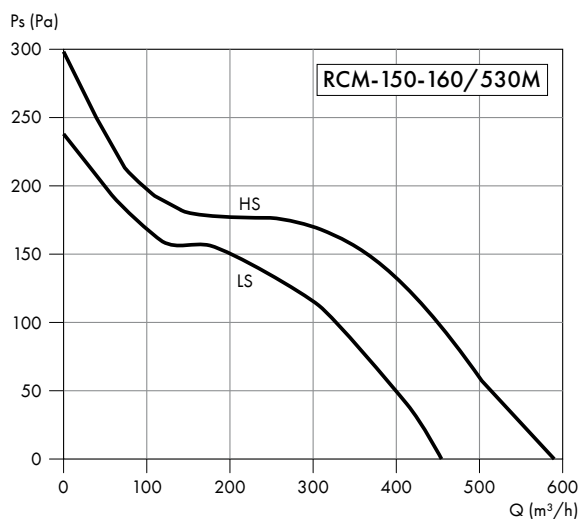

## Accessories



### HRS

Single-phase motor gear switch  
page 175



### HRB

Transformer speed controller  
page 176



### PSH

Pressure switch  
page 173



### PCC

Fastening clamp  
page 81



### HRX

Electronic speed controller  
page 174



### FKOV

Filter G3 for round ducts  
page 83



### AKUFLEX

Flexible acoustic silencer  
page 71



### RSKV

Backdraft damper  
page 41



### WSH

Service switch  
page 177



## Roof fans RKH



120°C



Powder-coated  
cover



Exhaust  
fan



Easy  
installation

### Design

Roof fan, radial, with horizontal air exhaust. Cover made of powder coated steel sheet. Rotor with backward curved impeller, welded steel sheet, powder coated and dynamically balanced curved impeller.

### Usage

The high permissible temperature of the transported medium makes the fan work not only in commercial facilities, but also in industrial installations in workshops, factories and steelworks. The fan can also be used in kitchen hoods.

### Electric motor

Asynchronous single-phase 230V, 50Hz, placed outside the air flow of removed air. Suitable for voltage regulation. Protection class IP 44, insulation class F.

### Operating temperature

The fan is designed to transmit air with a temperature not exceeding 120°C.

### Technical specifications

Model	Air flow [m <sup>3</sup> /h]	Impeller speed [rpm]	Power [W]	Current [A]	Voltage [V]	Frequency [Hz]	Sound pressure level [dB(A)]	Weight [kg]	Controller HRX	Controller HRB
RKH-315/2200 M	1800	2730	185	0,82	230	50	56-48	11,3	2,5	1,5

Sound pressure level measured outdoor at 4 and 10 m.

### Technical drawing

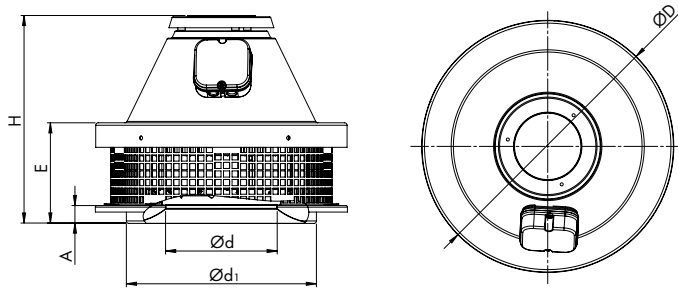

### Dimensions [mm]

Model	ØD	Ød <sub>1</sub>	Ød	A	E	H
RKH-315/2200 M	411	310	180	30	164	340

### Characteristics

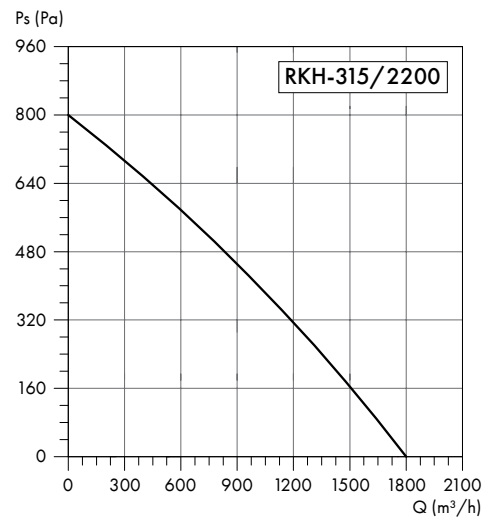

Frequency	Total	63	125	250	500	1000	2000	4000	8000	Hz
L <sub>WA</sub> Inlet	77	48	66	70	72	71	68	63	56	dB(A)
L <sub>WA</sub> Emitted	79	52	68	70	74	73	70	65	58	dB(A)

### Accessories



**HRX**  
Electronic speed controller  
page 174



**FKOV**  
Filter G3 for round ducts  
page 83



**PCC**  
Fastening clamp  
page 81



**RSKV**  
Backdraft damper  
page 41



**HRB**  
Transformer speed controller  
page 176



**PSH**  
Pressure switch  
page 173



**WSH**  
Service switch  
page 177

# Roof fans RKV

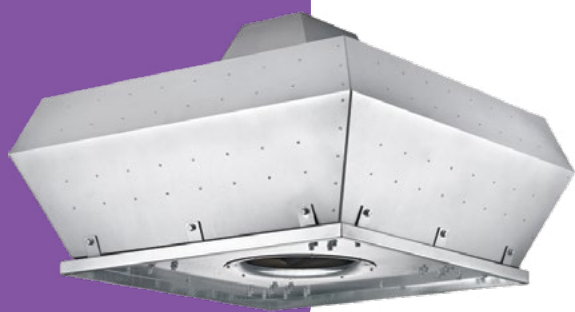

120°C



Vertical position



IP 55 protection class



Exhaust fan

## Design

Roof fan, radial with vertical air exhaust. Cover made of galvanised sheet. Rotor with backward curved impeller, made of galvanised sheet, dynamically balanced. The high rotor design significantly reduces noise emissions.

## Usage

RKV fans will work well in industrial installations removing polluted air with elevated temperatures, such as factories, steelworks, workshops, as well as restaurants, or housing facilities. The fan can also be used in kitchen hoods.

## Electric motor

Asynchronous single-phase 230V, 50Hz or three-phase 400V, 50Hz, adapted for frequency converter regulation. Protection class IP 55, insulation class F.

## Operating temperature

The fan is designed to transmit air with a temperature not exceeding 120°C.

## Technical specifications

Model	Air flow [m³/h]	Impeller speed [rpm]	Power [kW]	Current [A]	Voltage [V]	Frequency [Hz]	Capacitor [µF]	Sound pressure level [dB(A)]	Weight [kg]	Frequency converter	Inlet flange
RKV-315/2000 M	1900	1380	0,25	2,1	230	50	10	48-40	22	-	ILB 315
RKV-355/3000 M	2850	1380	0,25	2,1	230	50	10	50-42	27	-	ILB 355
RKV-400/4000 M	4000	1390	0,37	3,4	230	50	15	51-43	33	-	ILB 400
RKV-315/2000 T	1900	1380	0,25	0,87	400	50	-	48-40	22	Yes	ILB 315
RKV-355/3000 T	2850	1380	0,25	0,87	400	50	-	50-42	27	Yes	ILB 355
RKV-400/4000 T	4000	1390	0,37	1,2	400	50	-	51-43	33	Yes	ILB 400
RKV-450/5500 T	5300	1365	0,55	1,6	400	50	-	54-46	38	Yes	
RKV-500/7500 T	8000	1410	1,1	2,6	400	50	-	56-48	49	Yes	
RKV-560/10000 T	10500	1420	2,2	4,9	400	50	-	65-57	58	Yes	

Sound pressure level measured outdoor at 4 and 10 m.

## Technical drawing

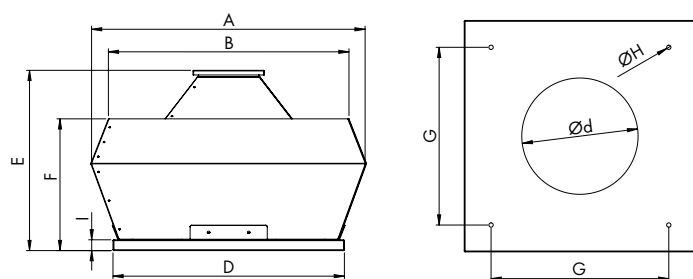

## Dimensions [mm]

Model	A	B	Ød	D	E	F	G	H	I
RKV-315/2000	845	740	185	700	550	395	576	14	35
RKV-355/3000	845	740	235	700	550	395	576	14	35
RKV-400/4000	895	780	270	750	585	430	576	14	35
RKV-450/5500	960	855	282	800	595	440	625	14	35
RKV-500/7500	1030	915	320	850	695	490	675	14	35
RKV-560/10000	1195	960	360	950	820	610	740	14	35

## Accessories



### HRX

Electronic speed controller  
page 174



### FKOV

Filter G3 for round ducts  
page 83



### PCC

Fastening clamp  
page 81



### RSKV

Backdraft damper  
page 41



### HRB

Transformer speed controller  
page 176



### PSH

Pressure switch  
page 173



### WSH

Service switch  
page 177

## Characteristics

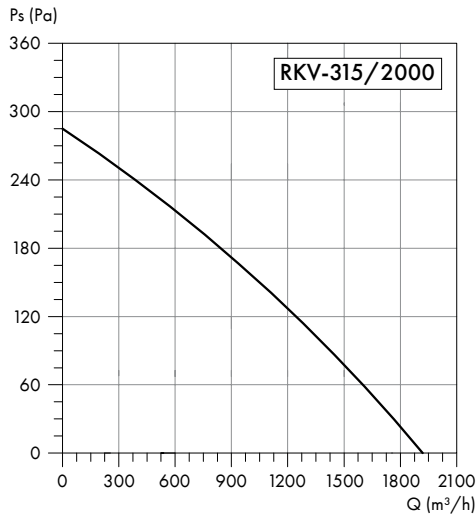

Frequency	Total	63	125	250	500	1000	2000	4000	8000	Hz
$L_{wa}$ Inlet	69	40	58	62	64	63	60	55	48	dB(A)
$L_{wa}$ Emitted	71	42	60	64	66	65	62	57	50	dB(A)

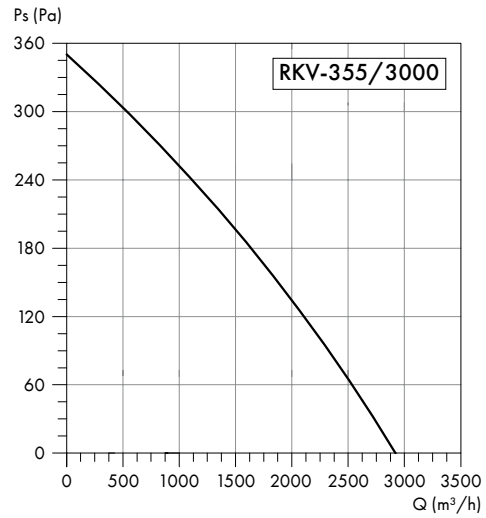

Frequency	Total	63	125	250	500	1000	2000	4000	8000	Hz
$L_{wa}$ Inlet	71	42	60	64	66	65	62	57	50	dB(A)
$L_{wa}$ Emitted	73	44	62	66	68	67	64	59	52	dB(A)

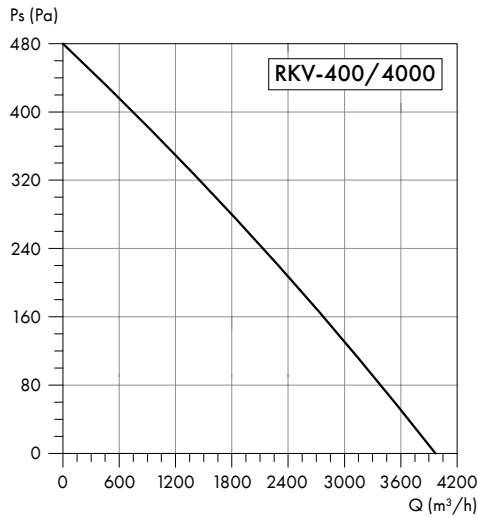

Frequency	Total	63	125	250	500	1000	2000	4000	8000	Hz
$L_{wa}$ Inlet	72	59	61	65	67	66	63	58	51	dB(A)
$L_{wa}$ Emitted	74	61	63	67	69	68	65	60	53	dB(A)

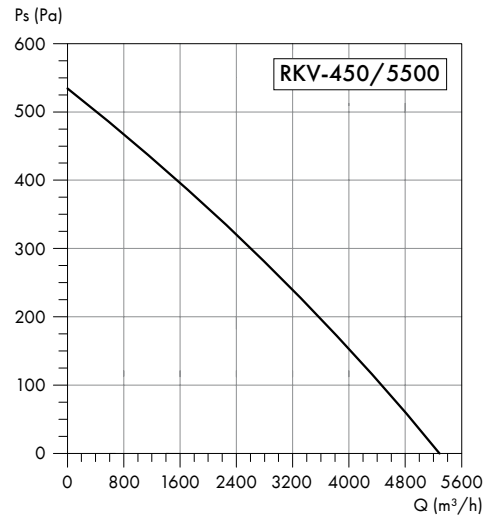

Frequency	Total	63	125	250	500	1000	2000	4000	8000	Hz
$L_{wa}$ Inlet	75	62	64	68	70	69	66	61	54	dB(A)
$L_{wa}$ Emitted	77	64	66	70	72	71	68	63	56	dB(A)

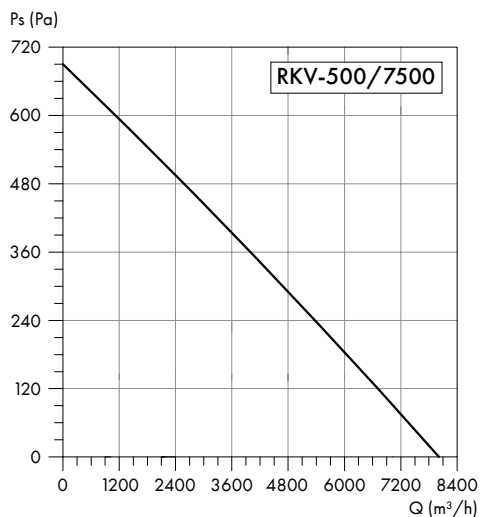

Frequency	Total	63	125	250	500	1000	2000	4000	8000	Hz
$L_{wa}$ Inlet	72	59	61	65	67	66	63	58	51	dB(A)
$L_{wa}$ Emitted	79	66	68	73	74	73	70	65	58	dB(A)

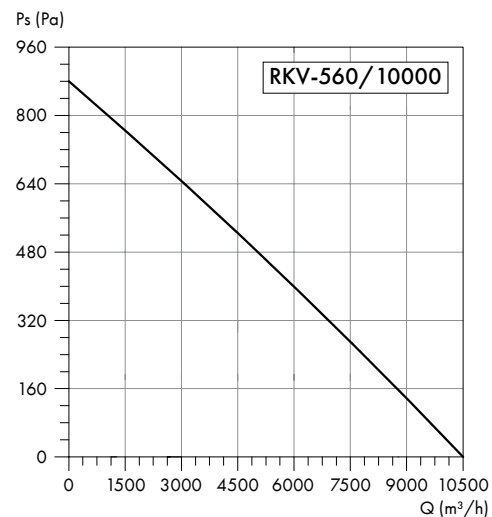

Frequency	Total	63	125	250	500	1000	2000	4000	8000	Hz
$L_{wa}$ Inlet	86	73	75	79	81	80	77	72	65	dB(A)
$L_{wa}$ Emitted	88	75	77	81	83	82	79	74	67	dB(A)



## Roof fans RBV



Exhaust fan



Vertical position



IP 44 protection class

### Design

Roof fan, radial with vertical air exhaust. Cover made of galvanised sheet. Rotor with backward curved impeller, made of galvanised sheet, dynamically balanced. A special system of drainage holes prevents the entry of rainwater into the interior of the installation.

### Usage

Vertical air exhaust makes the fan particularly suitable for applications that extract polluted air and cannot be thrown horizontally in facilities such as factories, hospitals, restaurants, offices and residential buildings.

### Electric motor

External motor with closed structure, powered by single-phase current 230V, 50Hz or three-phase 400V, 50Hz. Suitable for voltage regulation or frequency converter (3 phase products). Protection class IP 44, insulation class B or F.

### Operating temperature

The fan is designed to transmit air with a temperature not exceeding 50°C.

### Technical specifications

Model	Air flow [m³/h]	Impeller speed [rpm]	Power [W]	Current [A]	Voltage [V]	Frequency [Hz]	Capacitor [µF]	Sound pressure level [dB(A)]	Weight [kg]	Controller HRX	Controller HRB	Frequency converter	Inlet flange
RBV-225/850 M	850	2650	160	0,71	230	50	6	43-35	7	1,0	1,5	-	ILB 200
RBV-315/1650 M	1900	1450	150	0,92	230	50	6	45-37	22	2,5	1,5	-	ILB 315
RBV-355/2750 M	2850	1400	200	1,10	230	50	8	46-38	34	2,5	1,5	-	ILB 355
RBV-400/3600 M	4000	1380	310	1,56	230	50	10	47-39	39	2,5	3,0	-	ILB 400
RBV-450/5800 M	5400	1390	425	2,17	230	50	10	50-42	51	4,0	3,0	-	ILB 450
RBV-500/8000 T	7600/5700	1400/1050	960/620	2,0/1,1	400 Δ/Y	50	-	52-44	60	-	-	Yes	ILB 500
RBV-560/10000 T	9600/7300	1250/950	1515/870	2,9/1,7	400 Δ/Y	50	-	60-52	99	-	-	Yes	ILB 560

Sound pressure level measured outdoor at 4 and 10 m.

### Technical drawing

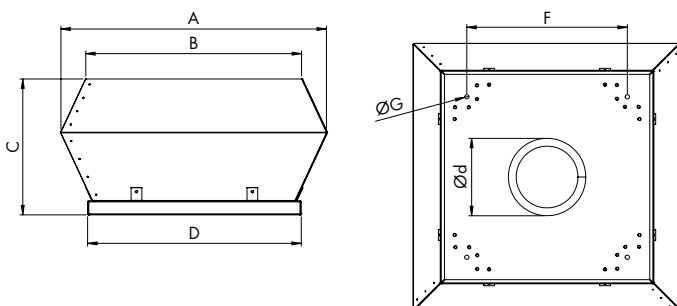

### Dimensions [mm]

Model	A	B	C	D	Ød	F	G
RBV-225/850 M	350	295	190	335	146	245	10
RBV-315/1650 M	552	450	330	505	185	450	10
RBV-355/2750 M	745	607	385	595	234	450	10
RBV-400/3600 M	745	607	385	595	270	450	10
RBV-450/5800 M	900	742	512	665	282	630	10
RBV-500/8000 T	900	742	512	665	320	630	12
RBV-560/10000 T	1190	955	595	946	360	740	12

### Accessories



**HRX**  
Electronic speed controller  
page 174



**FKOV**  
Filter G3 for round ducts  
page 83



**AKUFLEX**  
Flexible acoustic silencer  
page 71



**RSKV**  
Backdraft damper  
page 41



**HRB**  
Transformer speed controller  
page 176



**PSH**  
Pressure switch  
page 173



**PCC**  
Fastening clamp  
page 81



**WSH**  
Service switch  
page 177



## Characteristics

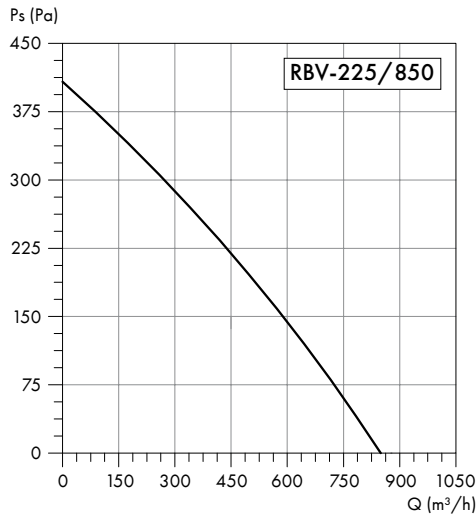

Frequency	Total	63	125	250	500	1000	2000	4000	8000	Hz
$L_{wA}$ Inlet	65	36	54	58	60	59	56	51	44	dB(A)
$L_{wA}$ Emitted	66	37	53	59	61	60	57	52	45	dB(A)

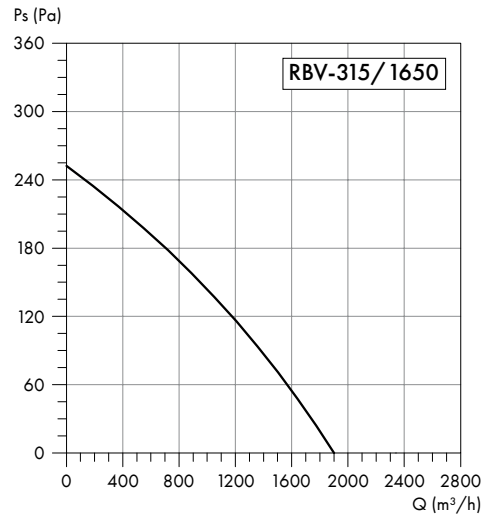

Frequency	Total	63	125	250	500	1000	2000	4000	8000	Hz
$L_{wA}$ Inlet	68	55	57	61	63	62	59	54	47	dB(A)
$L_{wA}$ Emitted	70	57	59	63	65	64	61	56	49	dB(A)

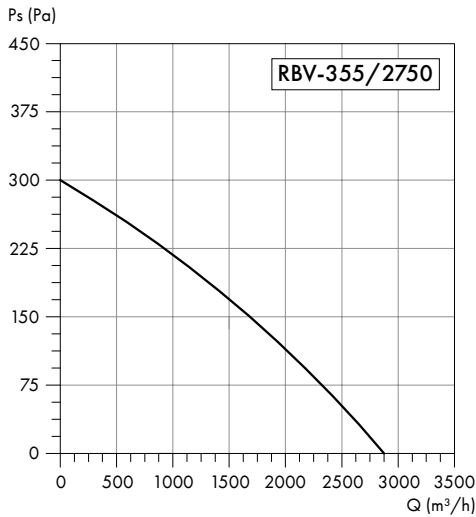

Frequency	Total	63	125	250	500	1000	2000	4000	8000	Hz
$L_{wA}$ Inlet	67	54	56	60	62	61	58	53	46	dB(A)
$L_{wA}$ Emitted	69	56	58	62	64	63	60	55	48	dB(A)

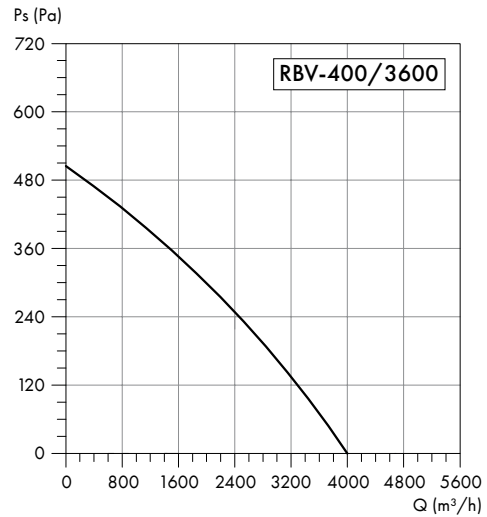

Frequency	Total	63	125	250	500	1000	2000	4000	8000	Hz
$L_{wA}$ Inlet	71	39	58	66	61	67	54	50	47	dB(A)
$L_{wA}$ Emitted	70	43	63	62	66	64	57	52	48	dB(A)

# Charakterystyki

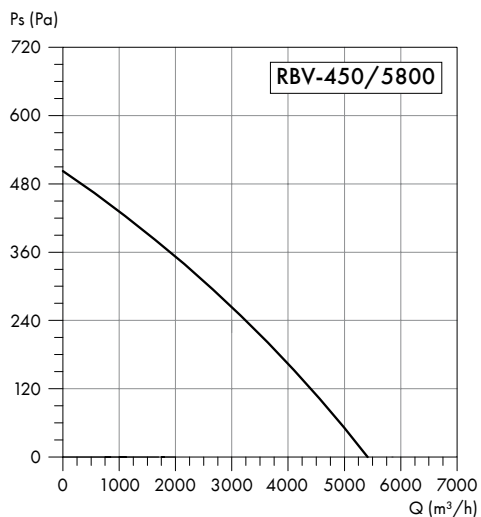

Frequency	Total	63	125	250	500	1000	2000	4000	8000	Hz
$L_{wA}$ Inlet	68	51	56	63	62	59	57	52	53	dB(A)
$L_{wA}$ Emitted	73	43	62	64	68	67	62	57	55	dB(A)

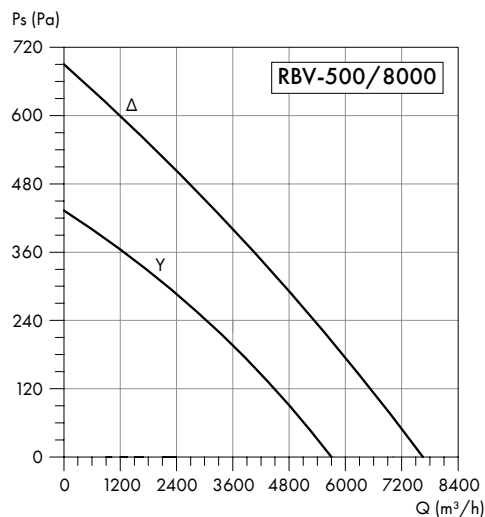

Frequency	Total	63	125	250	500	1000	2000	4000	8000	Hz
$L_{wA}$ Inlet	73	46	60	70	68	64	61	56	54	dB(A)
$L_{wA}$ Emitted	75	44	62	66	71	68	66	59	55	dB(A)

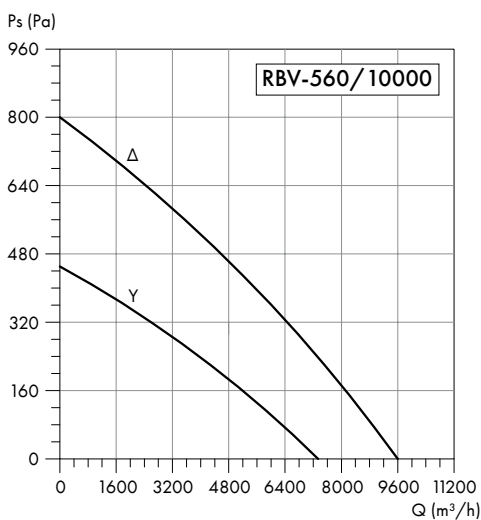

Frequency	Total	63	125	250	500	1000	2000	4000	8000	Hz
$L_{wA}$ Inlet	81	54	70	74	76	75	71	66	59	dB(A)
$L_{wA}$ Emitted	83	54	71	75	77	78	74	68	61	dB(A)



## Roof fans RAH



Works in supply or exhaust mode



Horizontal position



High efficiency

### Design

Roof fan, axial, with horizontal air exhaust. Cover made of steel sheet, powder coated. Rotor made of plastic, reinforced with glass fiber. The fan is designed to provide long-term, trouble-free continuous operation in both exhaust and supply modes.

### Usage

Relatively low pressure makes the fans ideal for ventilation of large objects, cooperating with a very short installation, such as: Production halls, warehouses, sports halls.

### Electric motor

Asynchronous single-phase 230V, 50Hz or three-phase 400V, 50Hz. Suitable for voltage regulation or frequency converter (3 phase products). Protection class IP 44 or IP55, insulation class B or F.

### Operating temperature

The fan is designed to transmit air with a temperature not exceeding 45°C.

### Technical specifications

Model	Air flow [m³/h]	Impeller speed [rpm]	Power [kW]	Current [A]	Voltage [V]	Frequency [Hz]	Capacitor [µF]	Sound pressure level [dB(A)]	Weight [kg]	Controller HRX	Controller HRB	Controller HRC/HRT	Frequency converter	Inlet flange
RAH-300/1800 M	1800	1445	0,09	0,45	230	50	3	47-39	16	1,0	1,5	-	-	ILB 315
RAH-350/2600 M	2600	1400	0,25	1,22	230	50	6	48-40	18	2,5	3,0	-	-	ILB 355
RAH-400/4500 M	4500	1375	0,25	1,24	230	50	6	51-43	20	2,5	3,0	-	-	ILB 400
RAH-450/6500 M	6500	1350	0,32	1,5	230	50	8	55-47	25	2,5	3,0	-	-	ILB 450
RAH-500/8500 M	8500	1350	0,37	1,75	230	50	12	57-49	30	2,5	3,0	-	-	ILB 500
RAH-560/10000 M	10400	1405	0,75	4,6	230	50	-	61-53	37	-	7,0	-	-	ILB 560
RAH-630/14000 M	14000	1410	1,1	7,1	230	50	-	63-55	45	-	-	11,0	-	ILB 630
RAH-710/18000 M	18000	1410	1,5	9,3	230	50	-	68-60	53	-	-	11,0	-	ILB 710
RAH-800/26000 M	26000	1425	2,2	13,4	230	50	-	70-62	75	-	-	-	-	ILB 800
RAH-300/1800 T	1800	1445	0,21	1,1	400	50	-	47-39	16	-	-	-	Yes	ILB 300
RAH-350/2600 T	2600	1400	0,27	1,3	400	50	-	48-40	18	-	-	-	Yes	ILB 355
RAH-400/4500 T	4500	1375	0,25	0,8	400	50	-	51-43	20	-	-	-	Yes	ILB 400
RAH-450/6500 T	6500	1240	0,36	1,6	400	50	-	55-47	25	-	-	-	Yes	ILB 450
RAH-500/8500 T	8500	1260	0,37	0,84	400	50	-	57-49	30	-	-	-	Yes	ILB 500
RAH-560/10000 T	10400	1405	0,75	2,1	400	50	-	61-53	37	-	-	-	Yes	ILB 560
RAH-630/14000 T	14000	1410	1,1	2,6	400	50	-	63-55	45	-	-	-	Yes	ILB 630
RAH-710/18000 T	18000	1410	1,5	3,5	400	50	-	68-60	53	-	-	-	Yes	ILB 710
RAH-800/26000 T	26000	1425	2,2	5,0	400	50	-	70-62	75	-	-	-	Yes	ILB 800
RAH-900/32000 T	32000	1425	3,0	6,6	400	50	-	74-66	80	-	-	-	Yes	ILB 900
RAH-1000/42000 T	42000	1440	5,5	8,4	400	50	-	77-69	105	-	-	-	Yes	ILB 1000

Sound pressure level measured outdoor at 4 and 10 m.

### Technical drawing

RAH-300 - RAH-500

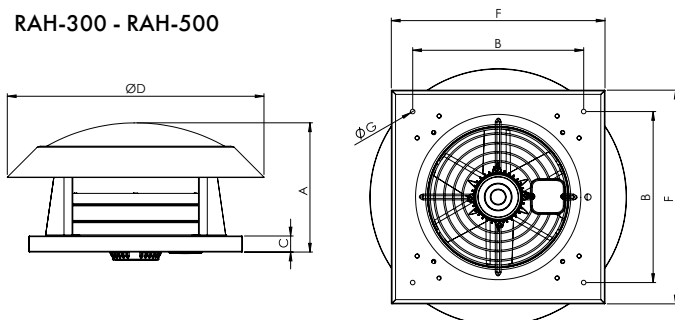

### Dimensions [mm]

Model	A	ØD	C	B	F	G
RAH-300/1800	340	685	40	450	560	12
RAH-350/2600	340	685	40	450	560	12
RAH-400/4500	470	824	40	530	630	12
RAH-450/6500	480	824	40	590	710	12
RAH-500/8500	480	824	40	680	740	12

## Technical drawing

RAH-560 - RAH-1000

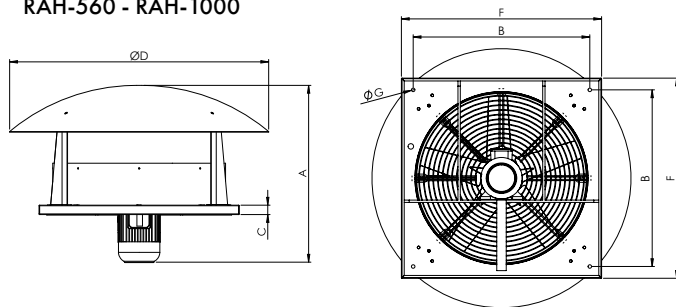

## Dimensions [mm]

Model	A	ØD	C	B	F	G
RAH-560/10000	710	1150	40	750	800	15
RAH-630/14000	710	1150	40	750	850	15
RAH-710/18000	800	1150	40	750	850	15
RAH-800/26000	900	1450	40	900	1000	15
RAH-900/32000	900	1450	40	900	1000	15
RAH-1000/42000	950	1450	40	1000	1100	15

## Characteristics

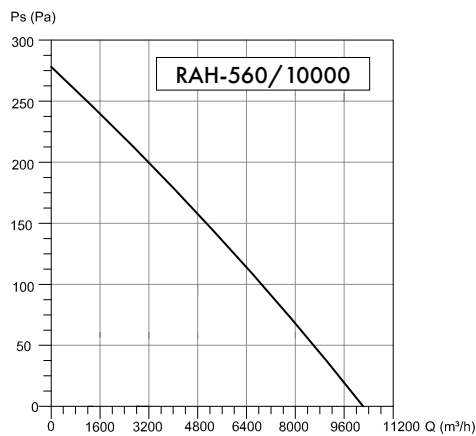
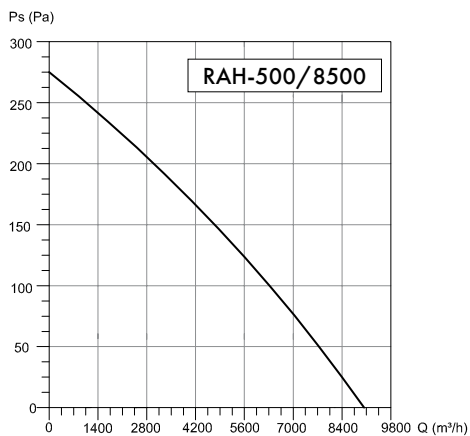
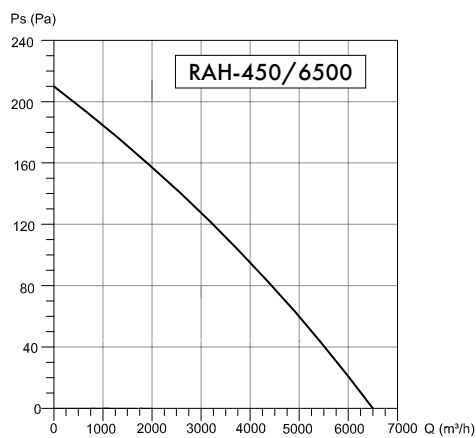
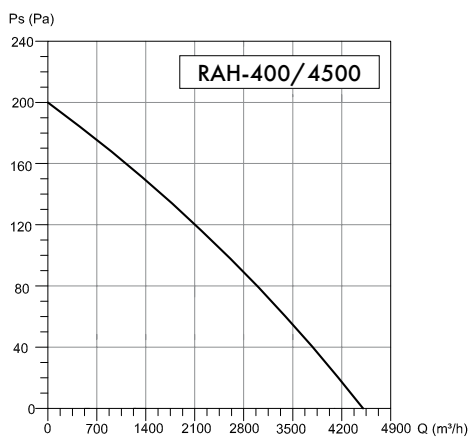
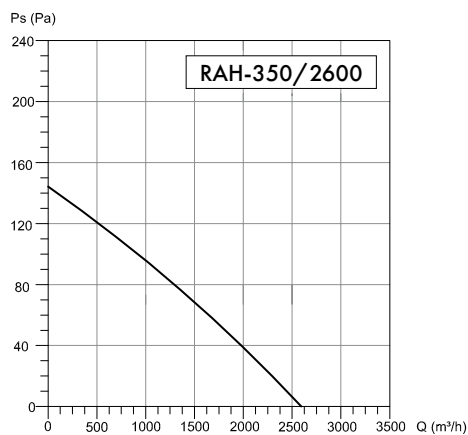
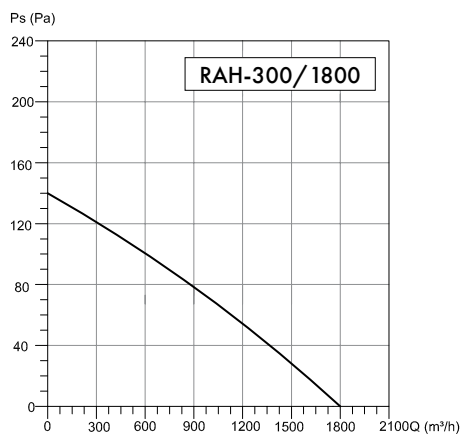

## Characteristics

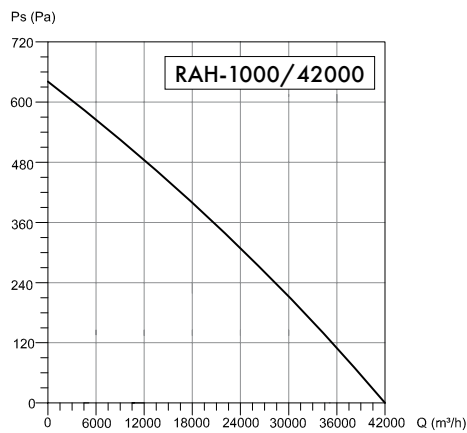
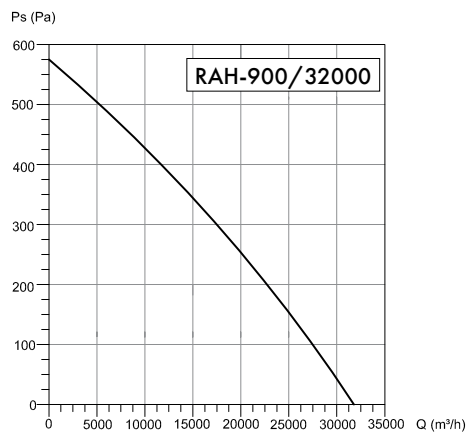
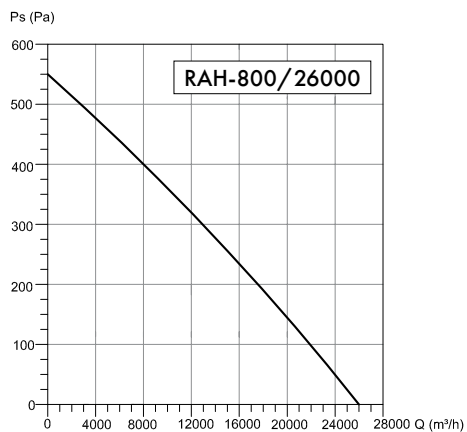
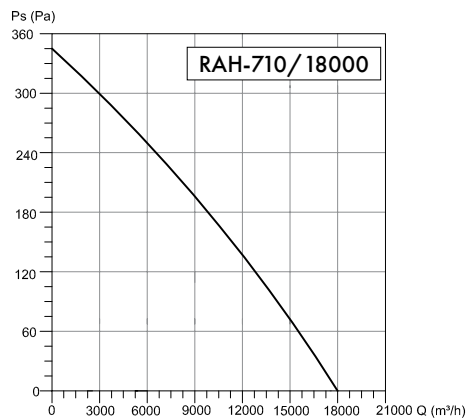
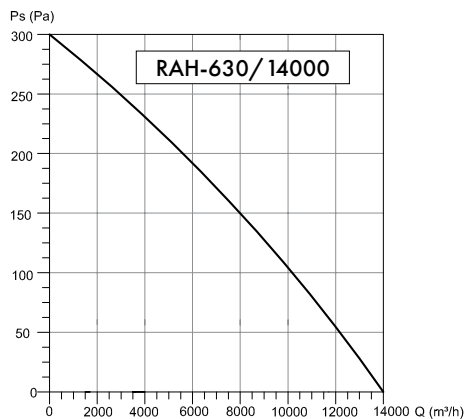

## Accessories



**HRX**  
Electronic speed controller  
page 174



**HRB**  
Transformer speed controller  
page 176



**HRC/HRT**  
Transformer speed controller  
page 176



**WSH**  
Service switch  
page 177



**PSH**  
Pressure switch  
page 173



**FKOV**  
Filter G3 for round ducts  
page 83



**AKUFLEX**  
Flexible acoustic silencer  
page 71



**RSKV**  
Backdraft damper  
page 41



## Axial fans AM6



6 blades made of powder-coated steel sheet



Powder-coated cover



Wall or window mounting

### Design

Axial fan for wall or window mounting. Mounting plate made of powder coated steel sheet. The rotor has 6 blades with a concave profile, made of powder-coated steel sheet. Air flow direction: motor-rotor.

### Usage

Ventilation of open spaces in shops, warehouses, workshops, paint shops, as well as residential buildings.

### Electric motor

Asynchronous single phase 230V, 50Hz. Suitable for voltage regulation or frequency converter (3 phase products). Protection class IP 44, insulation class B.

### Operating temperature

The fan is designed to transmit air with a temperature not exceeding 45°C.

### Technical specifications

Model	Air flow [m³/h]	Impeller speed [rpm]	Power [W]	Current [A]	Voltage [V]	Frequency [Hz]	Sound pressure level [dB(A)]	Weight [kg]	Controller HRX	Controller HRB	Frequency converter for 3~ products
AM6-250/2200 M / AM6-250/2200T	2200	2900	150 / 110	1,0 / 0,87	230 / 400	50	61	6,3	2,5	1,5	Yes
AM6-250/1200 M / AM6-250/1200T	1200	1475	65 / 50	0,4 / 0,35	230 / 400	50	45	6,0	1,0	1,5	Yes
AM6-300/2000 M / AM6-300/2000T	2000	1445	90 / 70	0,45 / 0,52	230 / 400	50	48	7,0	1,0	1,5	Yes
AM6-350/3200 M / AM6-350/3200T	3250	1460	160 / 120	1,05 / 0,30	230 / 400	50	53	8,2	2,5	1,5	Yes
AM6-400/4500 M / AM6-400/4500T	4500	1425	185 / 150	1,17 / 0,57	230 / 400	50	56	8,2	2,5	1,5	Yes
AM6-450/5000 M / AM6-450/5000T	5000	1430	200 / 170	1,1 / 0,75	230 / 400	50	60	9,6	2,5	1,5	Yes
AM6-500/5500 M / AM6-500/5500T	5500	1440	230 / 200	1,1 / 1,1	230 / 400	50	62	11,0	2,5	1,5	Yes
AM6-550/6000 M / AM6-550/6000T	6000	1440	220 / 220	1,07 / 1,07	230 / 400	50	63	15,3	2,5	1,5	Yes
AM6-600/8000 M / AM6-600/8000T	8000	1400	235 / 235	1,15 / 1,15	230 / 400	50	65	15,6	2,5	1,5	Yes

Sound pressure level measured outdoor at 3 m.

### Technical drawing

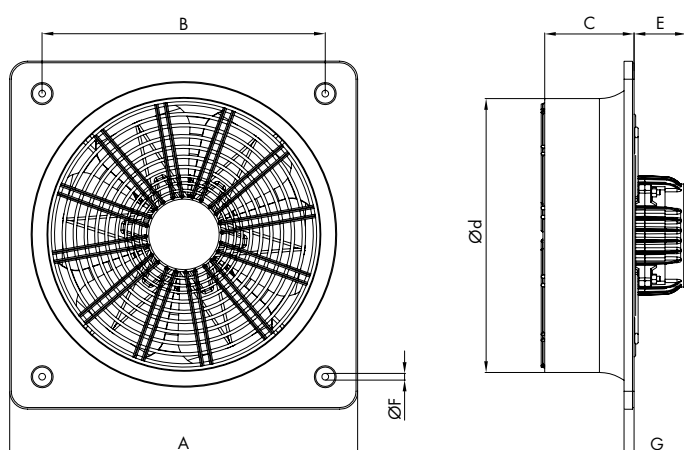

### Dimensions [mm]

Model	A	B	C	Ød	E	ØF	G
AM6-250/2200	333	275	80	261	80	8	10
AM6-250/1200	333	275	80	261	80	8	10
AM6-300/2000	412	336	80	307	80	8	10
AM6-350/3200	465	390	90	365	80	8	10
AM6-400/4500	500	420	100	403	80	8	10
AM6-450/5000	560	480	105	462	80	8	10
AM6-500/5500	630	561	110	513	90	8	10
AM6-550/6000	660	585	145	565	135	8	10
AM6-600/8000	700	631	145	612	135	8	10

## Characteristics

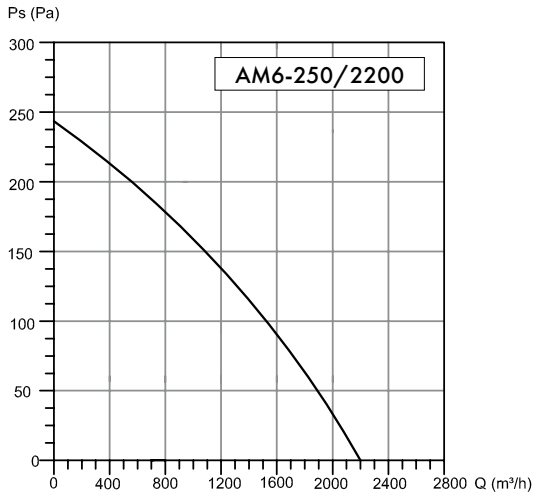

Frequency	Total	63	125	250	500	1000	2000	4000	8000	Hz
$L_{wA}$ Emited	82	56	67	76	75	77	75	70	64	dB(A)

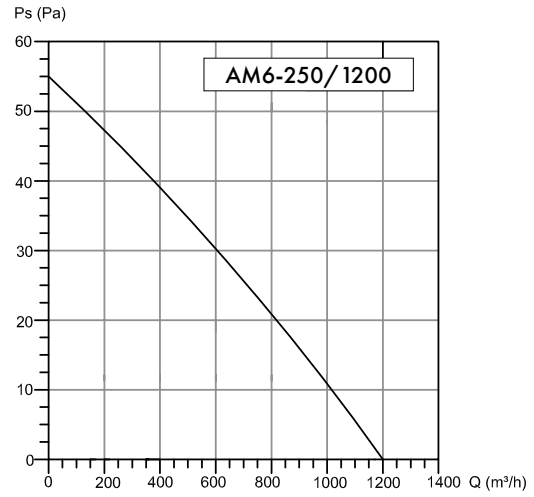

Frequency	Total	63	125	250	500	1000	2000	4000	8000	Hz
$L_{wA}$ Emited	66	34	48	55	60	61	60	55	47	dB(A)

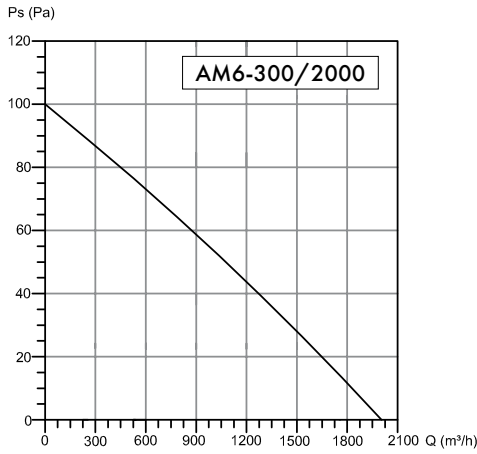

Frequency	Total	63	125	250	500	1000	2000	4000	8000	Hz
$L_{wA}$ Emited	69	43	54	60	62	64	61	56	51	dB(A)

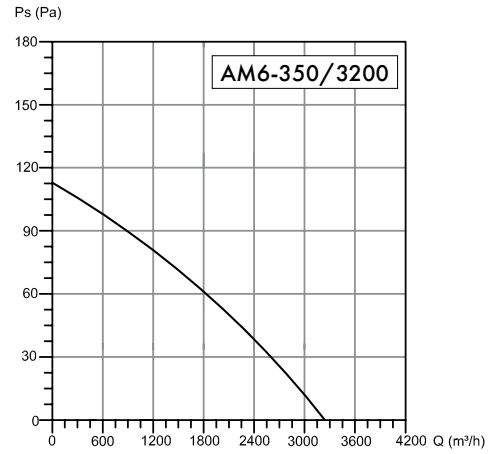

Frequency	Total	63	125	250	500	1000	2000	4000	8000	Hz
$L_{wA}$ Emited	74	40	59	58	65	71	65	63	54	dB(A)

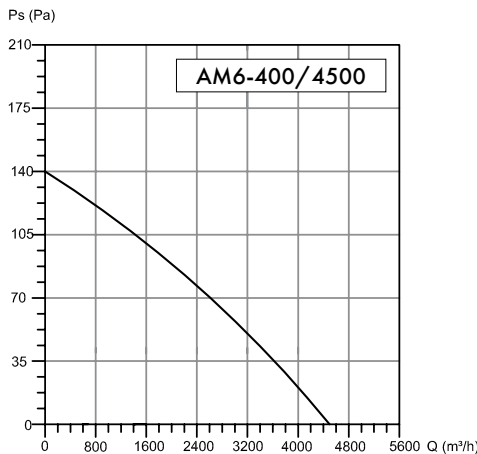

Frequency	Total	63	125	250	500	1000	2000	4000	8000	Hz
$L_{wA}$ Emited	77	49	62	63	70	73	70	65	56	dB(A)

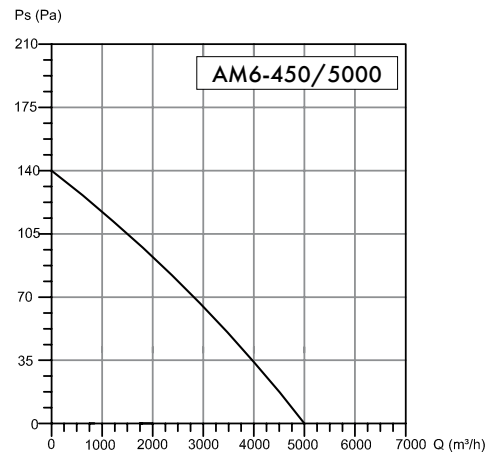

Frequency	Total	63	125	250	500	1000	2000	4000	8000	Hz
$L_{wA}$ Emited	81	48	67	64	70	77	76	71	63	dB(A)



## Characteristics

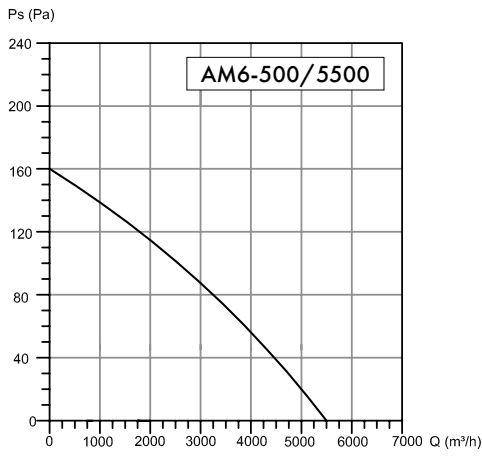

Frequency	Total	63	125	250	500	1000	2000	4000	8000	Hz
$L_{WA}$ Emited	83	50	69	70	74	78	77	73	66	dB(A)

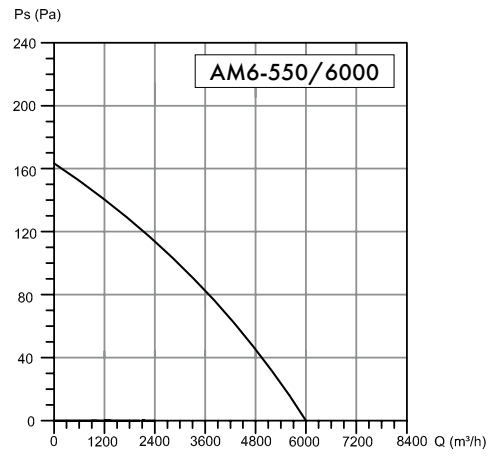

Frequency	Total	63	125	250	500	1000	2000	4000	8000	Hz
$L_{WA}$ Emited	85	57	70	74	78	80	78	74	67	dB(A)

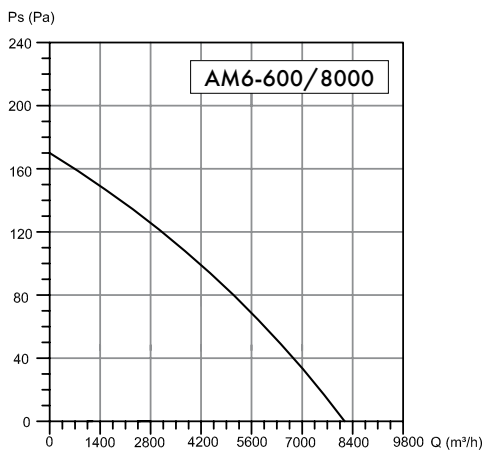

Frequency	Total	63	125	250	500	1000	2000	4000	8000	Hz
$L_{WA}$ Emited	86	54	69	73	78	82	79	76	72	dB(A)

## Accessories



### HRX

Electronic speed controller  
page 174



### HRB

Transformer speed controller  
page 176



### WSH

Service switch  
page 177



## Axial fans AP6



Installation in the wall or ceiling



A plastic rotor reinforced with fiberglass



Adapted for voltage speed control

### Design

Axial fan for wall or ceiling mounting. Mounting plate made of powder coated steel sheet. Rotor made of plastic, reinforced with glass fiber.

### Usage

Ventilation of large spaces, such as factories, warehouses, workshops, paint shops, assembly halls, shopping centers.

### Electric motor

Asynchronous single phase 230V, 50Hz. Suitable for voltage speed control or frequency converter (3 phase products). Protection class IP 44, insulation class B.

### Operating temperature

The fan is designed to transmit air with a temperature not exceeding 45°C.

### Technical specifications

Model	Air flow [m³/h]	Impeller speed [rpm]	Power [W]	Current [A]	Voltage [V]	Frequency [Hz]	Sound pressure level [dB(A)]	Weight [kg]	Controller HRX	Controller HRB	Frequency converter for 3~ products
AP6-250/2000 M / AP6-250/2000 T	1500	1450	70/120	0,4/0,75	230/400	50	54	7,3	1,0	1,5	Yes
AP6-300/3000 M / AP6-300/3000 T	2390	1450	85/150	0,45/0,65	230/400	50	57	8,5	1,0	1,5	Yes
AP6-350/4000 M / AP6-350/4000 T	4080	1400	250/190	1,22/0,8	230/400	50	60	9,9	2,5	1,5	Yes
AP6-400/5500 M / AP6-400/5500 T	5200	1375	255/255	1,24/0,8	230/400	50	63	10,4	2,5	1,5	Yes
AP6-450/7000 M / AP6-450/7000 T	6100	1250	360/290	1,6/0,82	230/400	50	61	11,4	2,5	3,0	Yes
AP6-500/8000 M / AP6-500/8000 T	7200	1250/1375	440/370	2,0/0,84	230/400	50	66	13,6	2,5	3,0	Yes

Sound pressure level measured outdoor at 3 m.

### Technical drawing

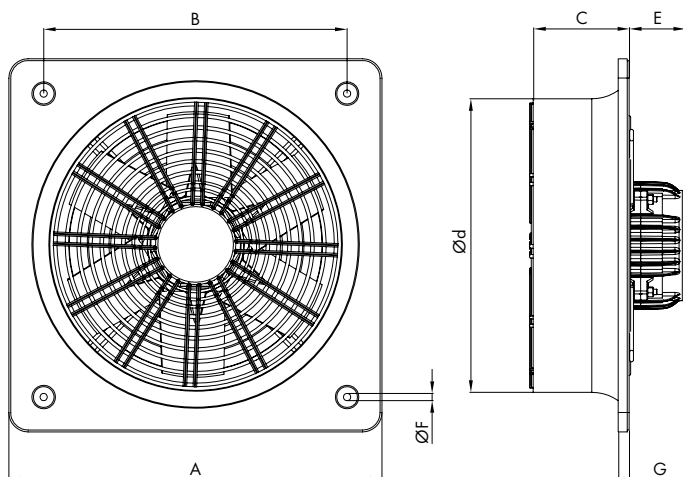

### Dimensions [mm]

Model	A	B	C	Ød	E	ØF	G
AP6-250/2000	333	275	80	261	80	8,25	10
AP6-300/3000	412	336	80	307	80	8,25	10
AP6-350/4000	465	390	90	365	80	8,25	10
AP6-400/5500	500	420	100	403	80	8,25	10
AP6-450/7000	560	480	105	462	80	8,25	10
AP6-500/8000	630	561	110	513	80	8,25	10

### Accessories



**HRX**  
Electronic speed controller  
page 174



**HRB**  
Transformer speed controller  
page 176



**WSH**  
Service switch  
page 177

# Characteristics

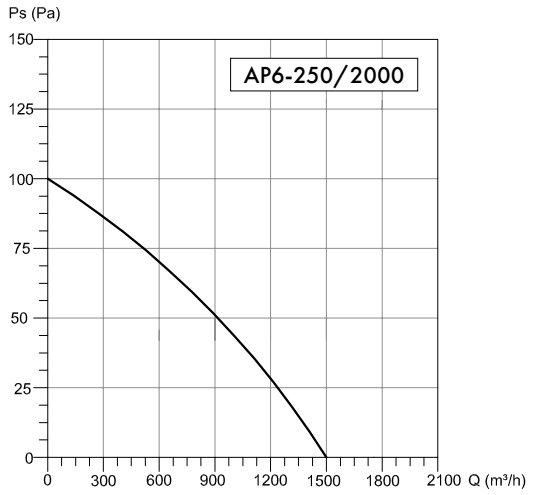

Frequency	Total	63	125	250	500	1000	2000	4000	8000	Hz
$L_{WA}$ Inlet	75	43	57	64	69	70	69	64	56	dB(A)

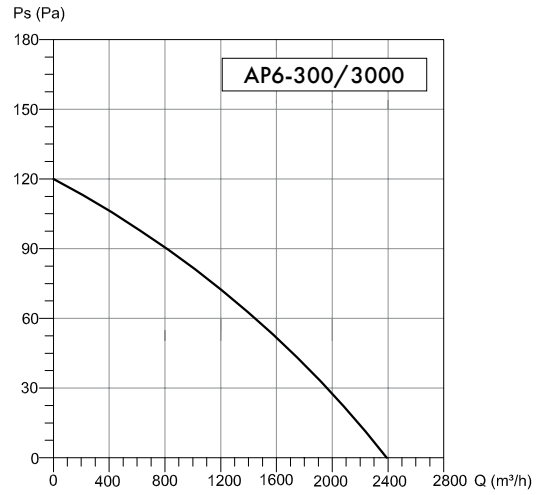

Frequency	Total	63	125	250	500	1000	2000	4000	8000	Hz
$L_{WA}$ Inlet	78	51	63	69	71	73	70	65	60	dB(A)

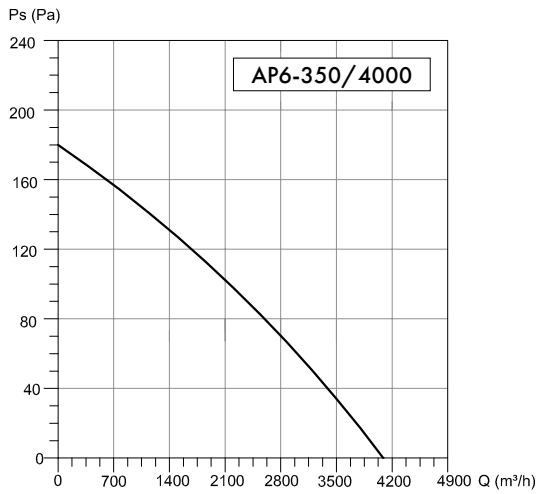

Frequency	Total	63	125	250	500	1000	2000	4000	8000	Hz
$L_{WA}$ Inlet	81	47	66	65	72	78	72	70	61	dB(A)

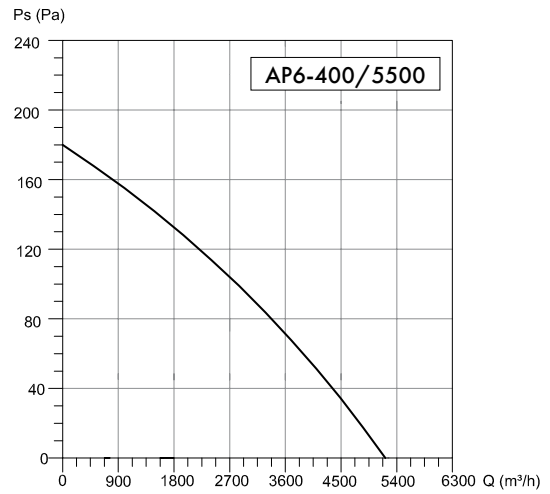

Frequency	Total	63	125	250	500	1000	2000	4000	8000	Hz
$L_{WA}$ Inlet	84	56	69	70	77	80	77	72	63	dB(A)

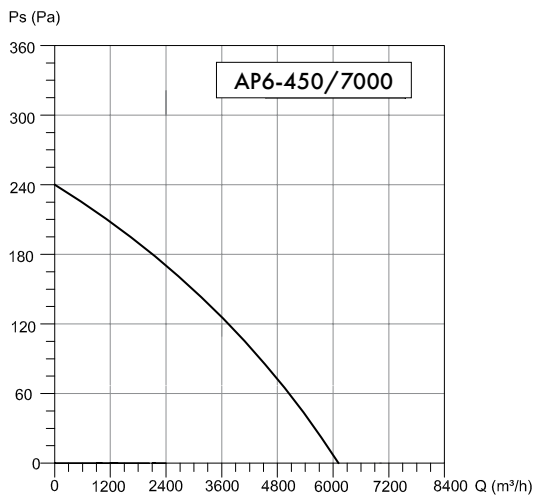

Frequency	Total	63	125	250	500	1000	2000	4000	8000	Hz
$L_{WA}$ Inlet	82	49	68	65	71	78	77	72	64	dB(A)

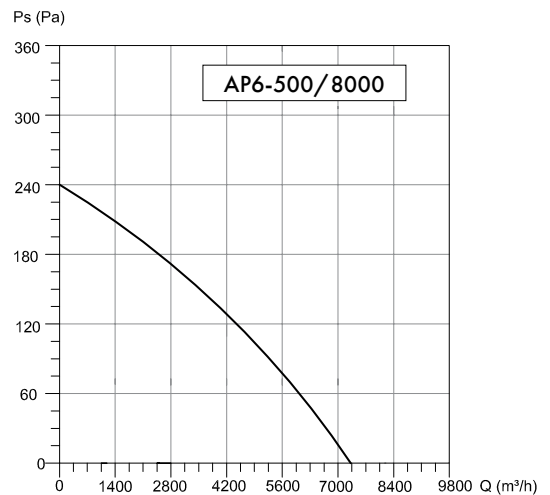

Frequency	Total	63	125	250	500	1000	2000	4000	8000	Hz
$L_{WA}$ Inlet	87	54	73	74	78	82	81	77	70	dB(A)

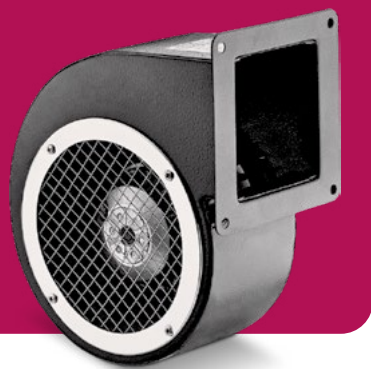

## Radial fans CLB



Steel cover



Dynamically balanced



Adapted for voltage regulation

### Design

Direct drive radial fan. Steel cover, welded, powder coated. Rotor forward curved blades, made of galvanised sheet, dynamically balanced.

### Usage

CLB fans are designed for blow-off installations for C.O. boilers, but they are equally ideal for cooling electronic components, laboratory and residential installations.

### Technical specifications

Model	Air flow [m <sup>3</sup> /h]	Impeller speed [rpm]	Power [W]	Current [A]	Voltage [V]	Frequency [Hz]	Capacitor [μF]	Sound pressure level [dB(A)]	Weight [kg]	Controller HRX	Controller HRB
CLB-125/250 M	250	2450	80	0,35	230	50	2,5	42	2,3	1,0	1,5
CLB-120/380 M	275	2250	85	0,38	230	50	2,5	46	2,5	1,0	1,5
CLB-140/600 M	485	2300	138	0,61	230	50	4,0	48	3,2	1,0	1,5
CLB-160/750 M	600	2250	200	0,88	230	50	6,0	52	4,3	2,5	1,5

Sound pressure level measured at 3m.

### Technical drawing

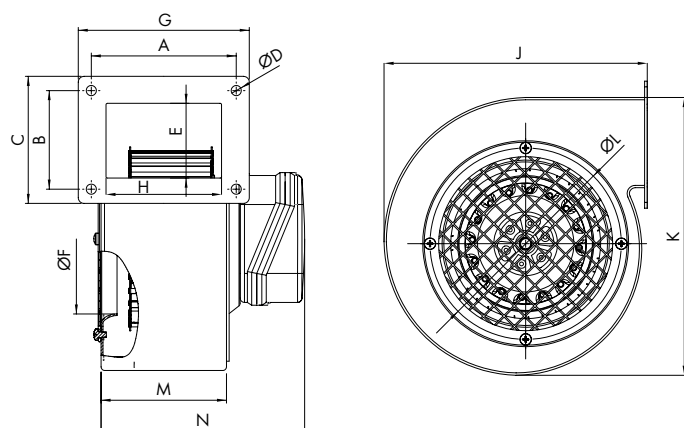

### Dimensions [mm]

Model	A	B	C	D	E	F	G	H	J	K	L	M	N
CLB-125/250 M	77,0	72,0	88,0	5	62,0	98,0	86,0	66,0	170	180	128	66	94
CLB-120/380 M	98,5	68,5	100,0	5	68,5	97,5	115,5	81,0	173	183	133	83	134
CLB-140/600 M	112,0	112,0	129,3	5	91,5	112,0	129,0	83,5	206	216	151	86	133
CLB-160/750 M	112,0	112,0	129,3	5	92,5	130,0	129,0	84,0	270	260	165	86	133

## Characteristics

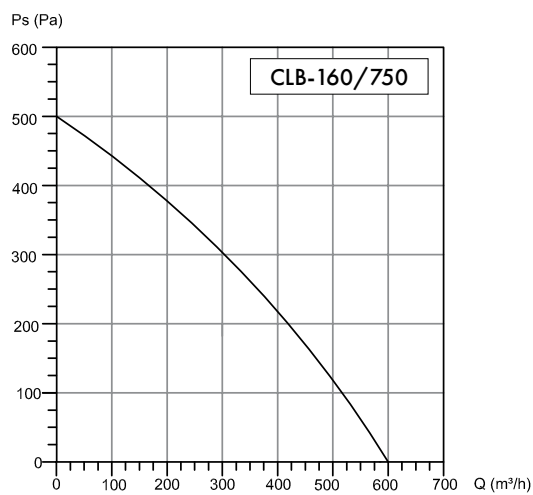
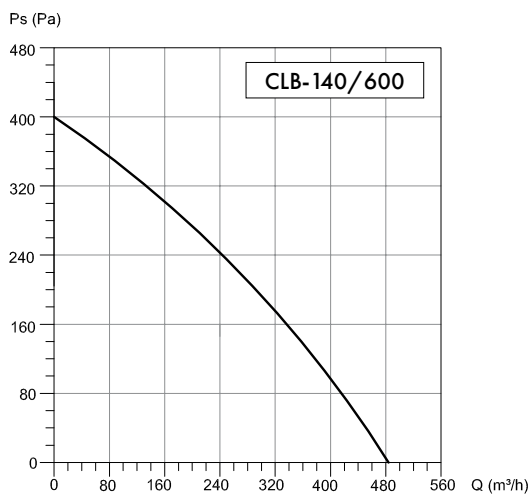
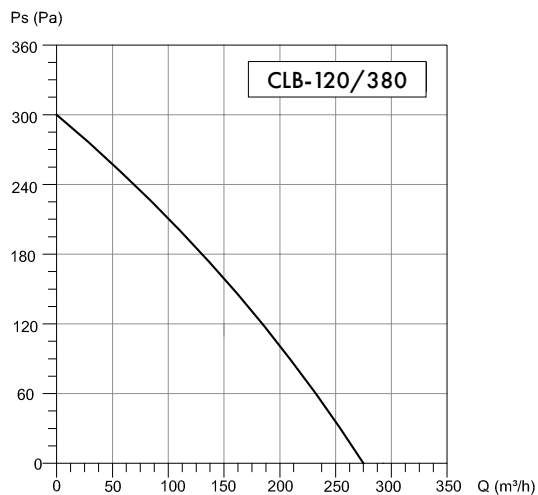
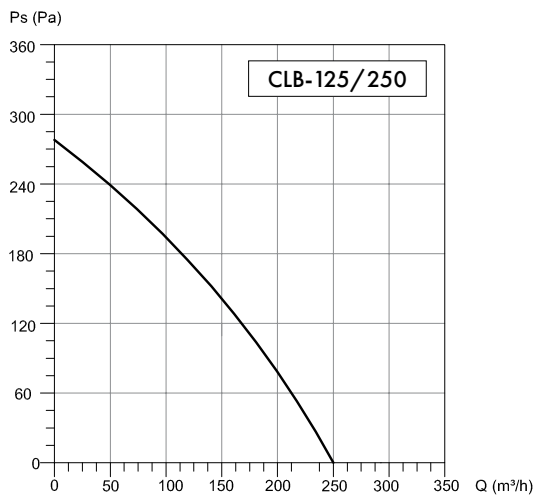

## Accessories



**HRX**  
Electronic speed controller  
page 174



**HRB**  
Transformer speed controller  
page 176



**WSH**  
Service switch  
page 177



## Radial fans CLA



Aluminum cover



Dynamically balanced



Adapted for voltage regulation



Powder-coated cover



IP 44 protection class

### Design

Direct drive radial fan. Steel cover, welded, powder coated. Rotor forward curved blades, made of galvanised sheet, dynamically balanced.

### Usage

Thanks to its compact and compact design, CLA fans are ideal for cooling installations of control cabinets, electric motors, as well as for blowing installations for boilers C.O.

### Technical specifications

Model	Air flow [m <sup>3</sup> /h]	Impeller speed [rpm]	Power [W]	Current [A]	Voltage [V]	Frequency [Hz]	Capacitor [µF]	Sound pressure level [dB(A)]	Weight [kg]	Controller HRX	Controller HRB
CLA-120/380 M	290	2400	85	0,38	230	50	2,5	45	2,8	1,0	1,5
CLA-140/590 M	485	2300	138	0,61	230	50	4,0	47	3,4	1,0	1,5
CLA-160/720 M	600	2250	200	0,88	230	50	6,0	50	4,3	2,5	1,5

Sound pressure level measured at 3m.

### Electric motor

Motor with rotating stator, powered by single phase current 230V, 50Hz. Suitable for voltage regulation. Protection class IP 44, insulation class B.

### Operating temperature

The fan is designed to transmit air with a temperature not exceeding 50°C.

### Technical drawing

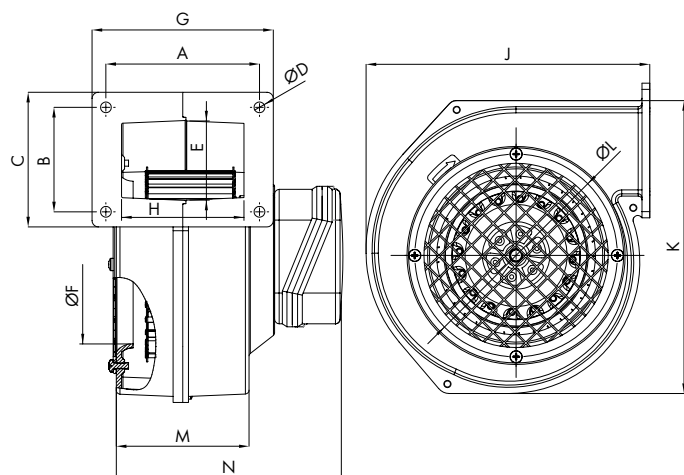

### Dimensions [mm]

Model	A	B	C	D	E	F	G	H	J	K	L	M	N
CLA-120/380 M	99	67,5	88	7	49	103,5	118,5	80,0	190	184	132,0	87	145
CLA-140/590 M	123	84	125	7	78	110,0	154,0	79,0	197	203	144,5	100	151
CLA-160/720 M	114	105	120	7	90	117,5	130,0	93,5	229	248	158,0	100	135

## Characteristics

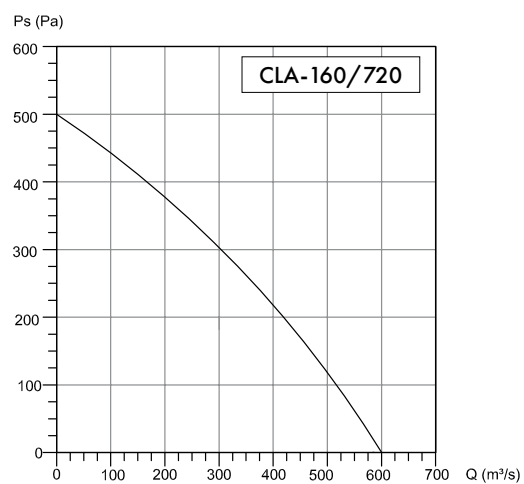
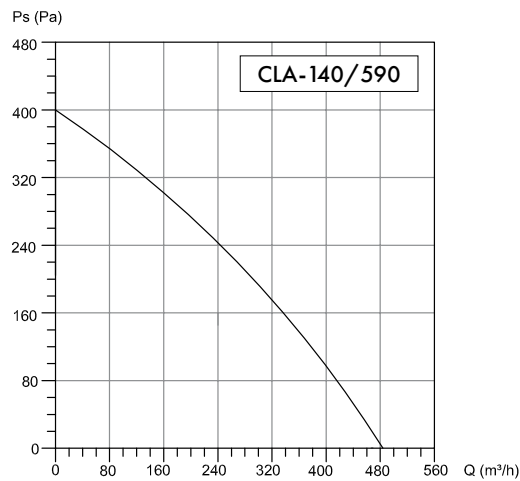
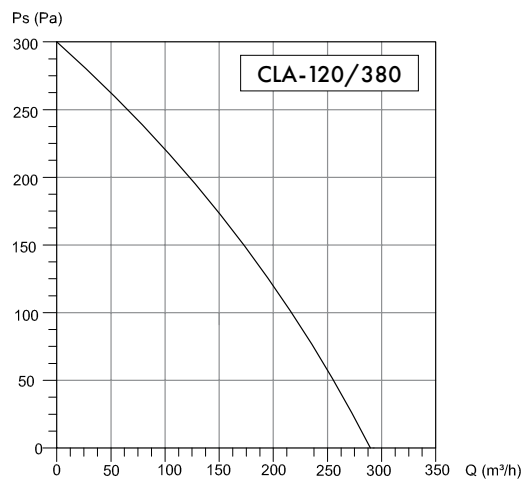

## Accessories



### HRX

Electronic speed controller  
page 174



### HRB

Transformer speed controller  
page 176



### WSH

Service switch  
page 177



## Radial fans CLC



Steel cover



Dynamically balanced



Adapted for voltage regulation



Powder-coated cover



IP 44 protection class

### Design

Direct drive radial fan. Steel cover, welded, powder coated. Rotor with forward curved blades, made of galvanised sheet, dynamically balanced.

### Usage

CLC fans are used in air pumping systems for production processes, ventilation and air conditioning systems, as well as in refrigeration equipment.

### Technical specifications

Model	Air flow [m <sup>3</sup> /h]	Impeller speed [rpm]	Power [W]	Current [A]	Voltage [V]	Frequency [Hz]	Capacitor [μF]	Sound pressure level [dB(A)]	Weight [kg]	Controller HRX	Controller HRB
CLC-200/1200 M	1200	2450	575	2,7	230	50	6,0	58	8,7	4,0	4,0

Sound pressure level measured at 3m.

### Electric motor

Motor with rotating stator, powered by single phase current 230V, 50Hz. Suitable for voltage regulation. Protection class IP 44, insulation class B.

### Operating temperature

The fan is designed to transmit air with a temperature not exceeding 45°C.

### Technical drawing

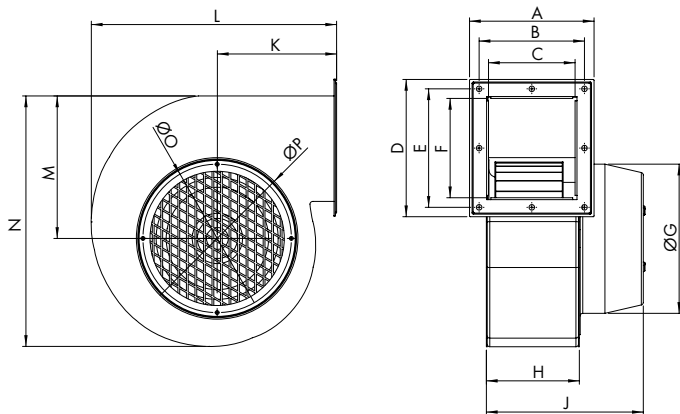

### Dimensions [mm]

Model	A	B	C	D	E	F	G	H	J	K	L	M	N	O	P
CLC-200/1200 M	150	125	105	163	139	120	174	109	185	142	290	170	298	143	186

### Characteristics

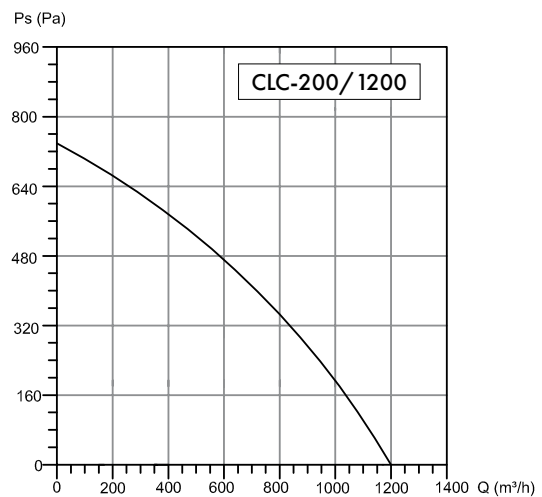

### Accessories



**HRX**  
Electronic speed controller  
page 174



**HRB**  
Transformer speed controller  
page 176



**WSH**  
Service switch  
page 177



# Heaters

Round • Rectangular • Accessories

HAVACO heaters are high-quality devices designed for installation in round ducts (ECH series) as well as rectangular ducts (ERH series). Each heater features, among other things, a two-stage protection against overheating. They are available both in versions without built-in automation and with built-in automation.



Safety



High Quality



Durability



Quick assembly



Reliability



**Series ECH**



**Series ERH**



**Accessories**



## Electrical heaters ECH



Steel cover with aluzinc coating



Two-stage overheating protection



EPDM gasket on connection ports



IP 44 protection class

### Description

ECH is an electric duct heater **without built-in automation**. The heating power of the heater can be adjusted via an external HRK controller. ECH heaters are designed for installation in round ducts. They are available in typical ventilation diameters from 100 to 500 mm and power from 0.3 to 24.0 kW. Each heater has a two-stage overheating protection: I stage at 50°C - automatic reset. II stage at 100°C - manual reset required.

### Usage

Duct heaters are used to heat clean air in domestic ventilation systems, especially in autumn and winter, as well as in industrial installations requiring a constant temperature of blown air. ECH heaters also work as pre-heaters or secondary heaters, complementing installations based on ventilation units with heat recovery.

### Design

The heater cover is made of steel sheet coated with a high-quality aluzinc coating, which guarantees high corrosion resistance. The connection ports are male and have an EPDM seal. The heating elements are made of AISI 304 stainless steel. The junction box has an IP44 protection class.



### Accessories



**PSH**  
Pressure switch  
page 173



**HRK1**  
Single- or two-phase heater controller  
page 173



**HTS**  
Electrical room thermostat  
page 174



**TJK10K**  
Duct temperature sensor  
page 173



**HRK3**  
Three-phase heater controller  
page 174



**HR5K**  
External temperature setpoint  
page 174

## Technical specifications

Model	Diameter d [mm]	Min. air flow rate [m <sup>3</sup> /h]	Voltage [V/50Hz]	Power [kW]
ECH 100	100	40	1~230	0.3,0.6,0.9,1.2
ECH 125	125	70	1~230	0.3, 0.6, 0.9, 1.2, 1.8, 2.4
ECH 160	160	110	1~230 2~400 3~400	0.3, 0.6, 0.9, 1.2, 1.8, 2.4 3.0, 5.0, 6.0 6.0
ECH 200	200	170	1~230 2~400 3~400	0.9, 1.2, 2.0, 2.4, 3.0 3.0, 5.0, 6.0 6.0
ECH 250	250	270	1~230 2~400 3~400	1.2, 2.0, 2.4, 3.0 3.0, 5.0, 6.0 6.0, 9.0, 12.0
ECH 315*	315	415	1~230 2~400 3~400	1.2, 2.0, 2.4, 3.0 3.0, 5.0, 6.0 6.0, 9.0, 12.0
ECH 400	400	690	1~230 2~400 3~400	3.0, 5.0, 6.0 3.0, 5.0, 6.0 6.0, 9.0, 12.0, 15.0, 18.0
ECH 500	500	1060	2~400 3~400	3.0, 5.0, 6.0 6.0, 9.0, 12.0, 15.0, 18.0, 24.0

\* Also available diameter of 355 mm.

## Technical drawing

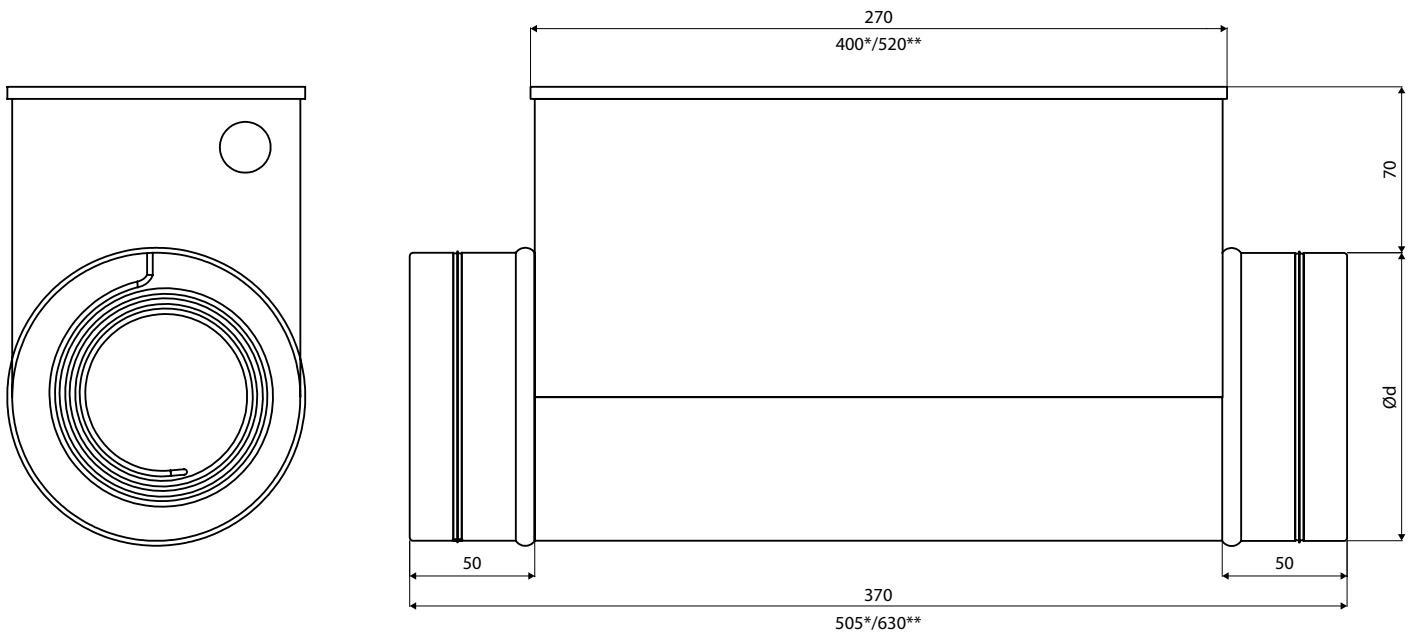

\* Dimensions for the 12kW size \*\* Dimensions for the 15 kW, 18 kW, 24 kW size

## Nomograms for the selection of heaters, page 161

# Electric heaters

## ECH NI/NV/NIS



Steel cover with aluzinc coating



Two-stage overheat protection



EDPM gasket on connection ports



Integrated automatic

### Description

ECH NI/NV/NIS is a series of electric duct heaters **with a built-in automation system containing a heater power controller**. The adjustment is performed by pulsation. The time between switching the heaters on and off is adjusted by the regulator to ensure that the set temperature is maintained. The NV/NI/NIS series differ in the way the target value is set:

**NI** – Temperature setpoint using potentiometer located on heater housing.

**NV** – Temperature setting using HR5K external setpoint.

**NIS** – Temperature set-point via external control signal 0-10V, e.g. signal from panel automation or BMS system.

ECH heaters are designed for installation in round ducts. They are available in typical ventilation diameters from 100 to 500 mm and power from 0.3 to 24.0 kW.

Each heater has a two-stage overheat protection:

I stage at 50°C - automatic reset. II stage at 100°C – manual reset required.

### Usage

Duct heaters are used to heat clean air in domestic ventilation systems, especially in autumn and winter, as well as in industrial installations requiring a constant temperature of blown air.

ECH heaters also work as pre-heaters or secondary heaters, complementing installations based on ventilation units with heat recovery.

### Design

The heater housing is made of steel sheet coated with a high-quality aluzinc coating, which guarantees high corrosion resistance. The connection ports are male and have an EPDM seal. The heating elements are made of AISI 304 stainless steel. The junction box has an IP44 protection class.

### Technical specifications

Model	Diameter d [mm]	Min. air flow rate [m <sup>3</sup> /h]	Voltage [V/50Hz]	Power [kW]
ECH NV/NI/NIS 100	100	40	1~230	0.3, 0.6, 0.9, 1.2
ECH NV/NI/NIS 125	125	70	1~230	0.3, 0.6, 0.9, 1.2, 1.8, 2.4
ECH NV/NI/NIS 160	160	110	1~230 2~400 3~400	0.3, 0.6, 0.9, 1.2, 1.8, 2.4 3.0, 5.0, 6.0 6.0
ECH NV/NI/NIS 200	200	170	1~230 2~400 3~400	0.9, 1.2, 2.0, 2.4, 3.0 3.0, 5.0, 6.0 6.0
ECH NV/NI/NIS 250	250	270	1~230 2~400 3~400	1.2, 2.0, 2.4, 3.0 3.0, 5.0, 6.0 6.0, 9.0, 12.0
ECH NV/NI/NIS 315	315	415	1~230 2~400 3~400	1.2, 2.0, 2.4, 3.0 3.0, 5.0, 6.0 6.0, 9.0, 12.0
ECH NV/NI/NIS 400	400	690	1~230 2~400 3~400	3.0, 5.0, 6.0 3.0, 5.0, 6.0 6.0, 9.0, 12.0, 15.0, 18.0
ECH NV/NI/NIS 500	500	1060	2~400 3~400	3.0, 5.0, 6.0 6.0, 9.0, 12.0, 15.0, 18.0, 24.0

### Accessories



**PSH**

Pressure switch  
page 173



**TJK10K**

Duct temperature sensor  
page 173



**HR5K**

External temperature setpoint  
page 174

## Recommend install

### ECH NI

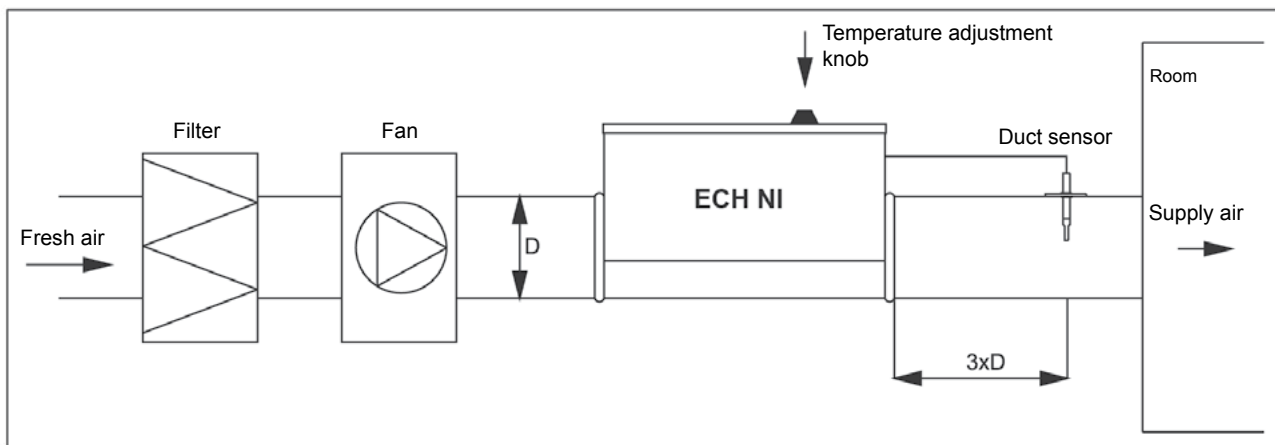

### ECH NV

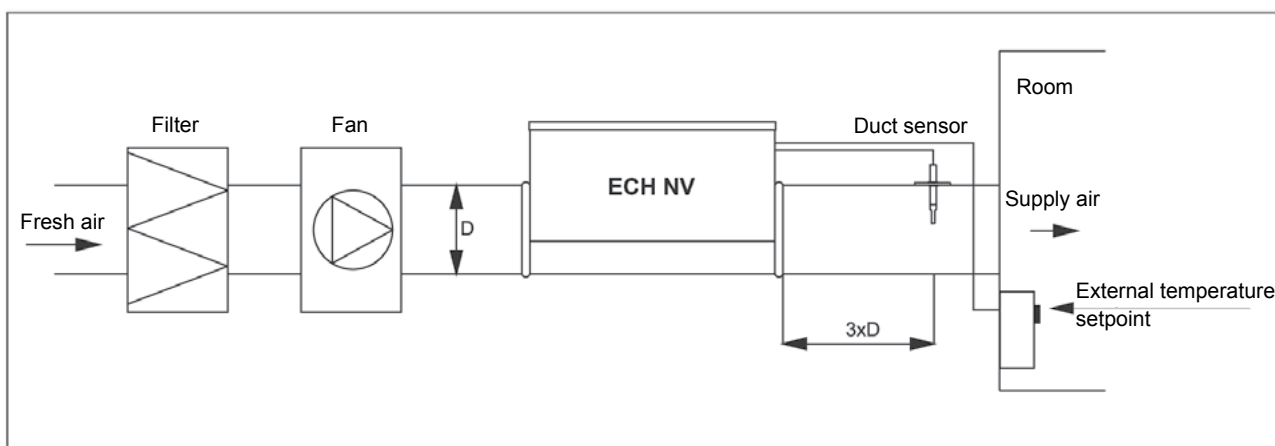

### ECH NIS

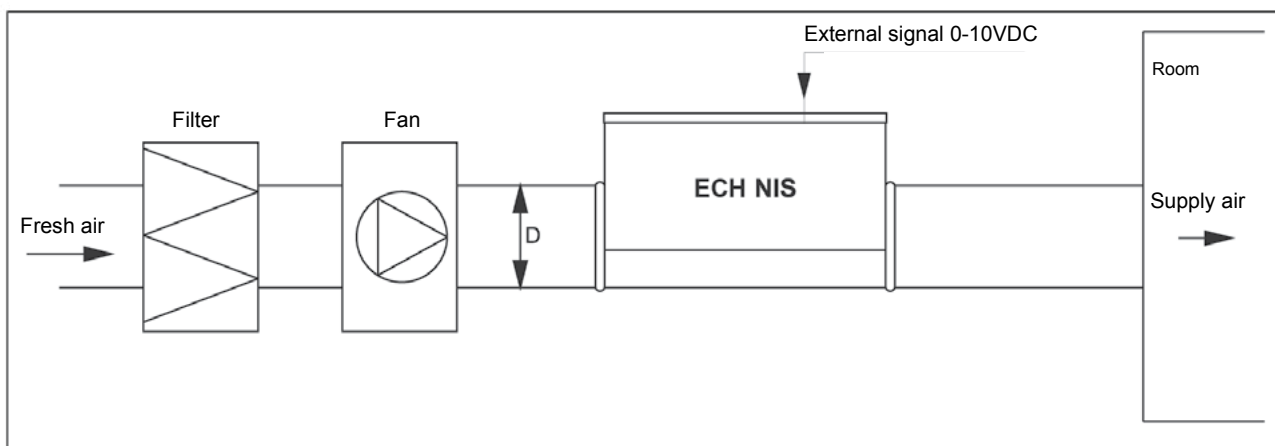

Technical drawing, page 157

Nanograms for the heater selections, page 161

# Electric heaters

## ECH NI PTX/PSX



Steel cover with aluzinc coating



Two-stage overheating protection



EDPM gasket on connection ports



Integrated automatic

### Description

ECH NI PTX/PSX is a series of electric duct heaters with a **built-in automation system including heater power controller and flow sensor (PTX) and pressure switch (PSX)**. The adjustment is performed by pulsation. The time between switching the heaters on and off is adjusted by the regulator to ensure that the set temperature is maintained. The temperature setpoint is set using a potentiometer located on the heater cover. If there is no air flow, the heating function is deactivated regardless of the air temperature downstream of the heater.

ECH heaters are designed for installation in round ducts. They are available in typical ventilation diameters from 100 to 500 mm and power from 0.3 to 24.0 kW. Each heater has a two-stage overheating protection:

I stage at 50°C - automatic reset.

II stage at 100°C - manual reset required.

### Usage

Duct heaters are used to heat clean air in domestic ventilation systems, especially in autumn and winter, as well as in industrial installations requiring a constant temperature of blown air.

ECH heaters also work as pre-heaters or secondary heaters, complementing installations based on ventilation units with heat recovery.

### Design

The heater cover is made of steel sheet coated with a high-quality aluzinc coating, which guarantees high corrosion resistance. The connection ports are male and have an EPDM seal.

The heating elements are made of AISI 304 stainless steel.

The junction box has an IP44 protection class.

### Dane techniczne

Model	Diameter d [mm]	Min. air flow rate [m <sup>3</sup> /h]	Voltage [V/50Hz]	Power [kW]
ECH NI PTX/PSX 100	100	40	1~230	0.3, 0.6, 0.9, 1.2
ECH NI PTX/PSX 125	125	70	1~230	0.3, 0.6, 0.9, 1.2, 1.8, 2.4
ECH NI PTX/PSX 160	160	110	1~230 2~400 3~400	0.3, 0.6, 0.9, 1.2, 1.8, 2.4 3.0, 5.0, 6.0 6.0
ECH NI PTX/PSX 200	200	170	1~230 2~400 3~400	0.9, 1.2, 2.0, 2.4, 3.0 3.0, 5.0, 6.0 6.0
ECH NI PTX/PSX 250	250	270	1~230 2~400 3~400	1.2, 2.0, 2.4, 3.0 3.0, 5.0, 6.0 6.0, 9.0, 12.0
ECH NI PTX/PSX 315	315	415	1~230 2~400 3~400	1.2, 2.0, 2.4, 3.0 3.0, 5.0, 6.0 6.0, 9.0, 12.0
ECH NI PTX/PSX 400	400	690	1~230 2~400 3~400	3.0, 5.0, 6.0 3.0, 5.0, 6.0 6.0, 9.0, 12.0, 15.0, 18.0
ECH NI PTX/PSX 500	500	1060	2~400 3~400	3.0, 5.0, 6.0 6.0, 9.0, 12.0, 15.0, 18.0, 24.0

Nanograms for the selection of round heaters

## ECH 100/.../1f

Air temperature: 20 °C

No.	ECH 100/03		ECH 100/06		ECH 100/09		ECH 100/12	
	Qv (m <sup>3</sup> /h)	Δp (Pa)	Qv (m <sup>3</sup> /h)	Δp (Pa)	Qv (m <sup>3</sup> /h)	Δp (Pa)	Qv (m <sup>3</sup> /h)	Δp (Pa)
1	0	0,0	0	0,0	0	0,0	0	0,0
2	25	0,5	25	0,8	25	1,1	25	1,5
3	50	2,1	50	3,1	50	4,4	50	5,9
4	75	4,7	75	7,0	75	9,9	75	13,3
5	100	8,3	100	12,5	100	17,6	100	23,6
6	150	18,8	150	28,1	150	39,5	150	53,0
7	200	33,3	200	50,0	200	70,2	200	94,3
8	250	52,1	250	78,1	250	109,7	250	147,3
9	300	75,0	300	112,5	300	158,0	300	212,1
10	350	102,1	350	153,1	350	215,1	350	288,7
11	400	133,3	400	200,0	400	281,0	400	377,1
12	450	168,8	450	253,1	450	355,6	450	477,2
13	500	208,3	500	312,5	500	439,0	500	589,2
14	600	300,0	600	450,0	600	632,2	600	848,4

ECH 100

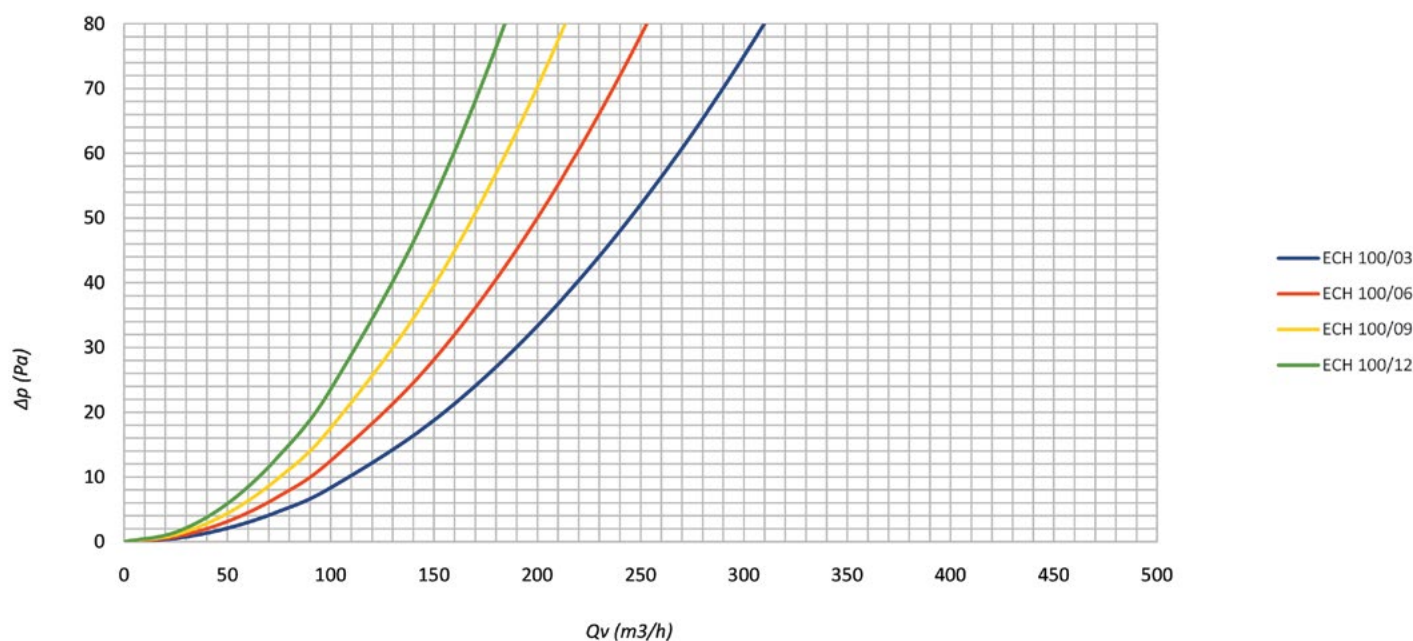



# ECH 125/.../1f

Air temperature: 20 °C

No.	ECH 125/03		ECH 125/06		ECH 125/09		ECH 125/12		ECH 125/15		ECH 125/18		ECH 125/24	
	Qv [m³/h]	Δp [Pa]	Qv [m³/h]	Δp [Pa]	Qv [m³/h]	Δp [Pa]	Qv [m³/h]	Δp [Pa]	Qv [m³/h]	Δp [Pa]	Qv [m³/h]	Δp [Pa]	Qv [m³/h]	Δp [Pa]
1	0	0,0	0	0,0	0	0,0	0	0,0	0	0,0	0	0,0	0	0,0
2	25	0,1	25	0,2	25	0,2	25	0,2	25	0,3	25	0,3	25	0,5
3	50	0,5	50	0,6	50	0,8	50	1,0	50	1,2	50	1,3	50	2,1
4	75	1,1	75	1,4	75	1,8	75	2,2	75	2,8	75	2,8	75	4,7
5	100	1,9	100	2,5	100	3,2	100	3,9	100	4,9	100	5,0	100	8,4
6	150	4,3	150	5,7	150	7,2	150	8,8	150	11,1	150	11,3	150	18,9
7	200	7,7	200	10,1	200	12,8	200	15,6	200	19,8	200	20,0	200	33,7
8	250	12,1	250	15,7	250	20,0	250	24,4	250	30,9	250	31,3	250	52,6
9	300	17,4	300	22,6	300	28,8	300	35,1	300	44,4	300	45,1	300	75,7
10	350	23,6	350	30,8	350	39,2	350	47,8	350	60,5	350	61,4	350	103,1
11	400	30,9	400	40,2	400	51,2	400	62,4	400	79,0	400	80,2	400	134,6
12	450	39,1	450	50,9	450	64,8	450	78,9	450	100,0	450	101,5	450	170,4
13	500	48,2	500	62,9	500	80,0	500	97,5	500	123,5	500	125,3	500	210,3
14	600	69,4	600	90,5	600	115,2	600	140,3	600	177,8	600	180,4	600	302,9

ECH 125

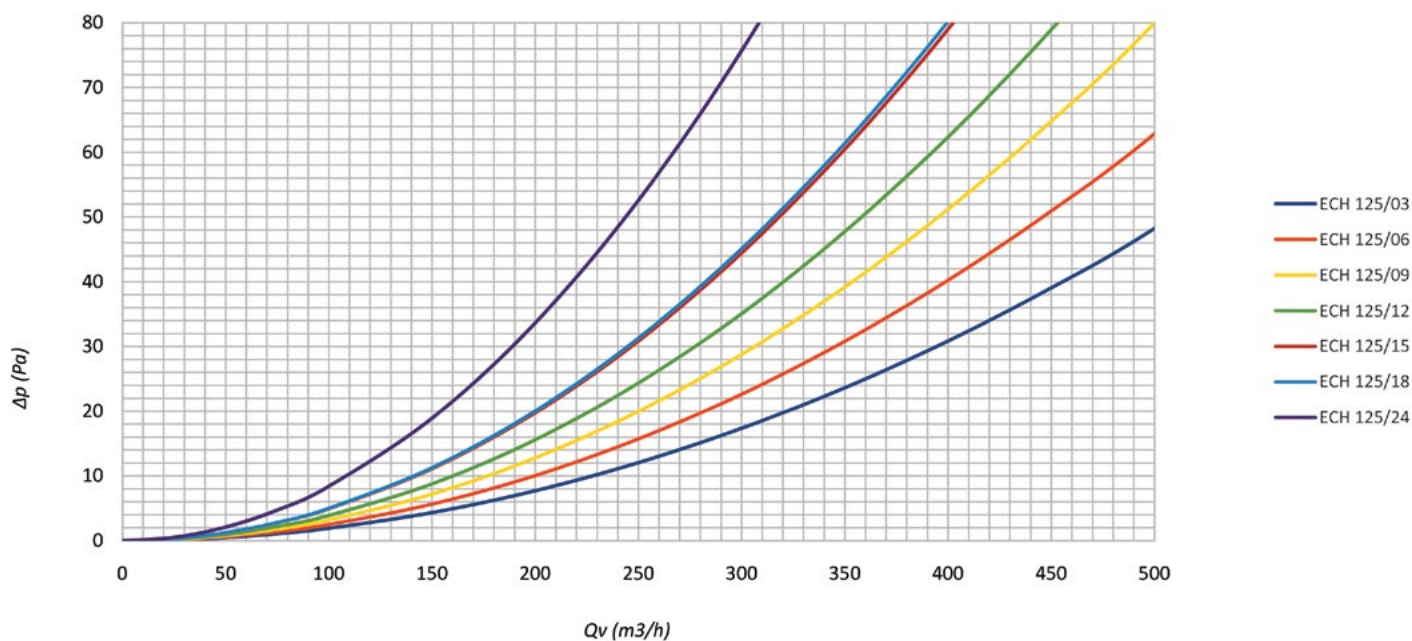



# ECH 160/.../1f

Air temperature: 18 °C

No.	ECH 160/12		ECH 160/20		ECH 160/24		ECH 160/30		ECH 160/50		ECH 160/60	
	Qv [m³/h]	Δp [Pa]	Qv [m³/h]	Δp [Pa]	Qv [m³/h]	Δp [Pa]	Qv [m³/h]	Δp [Pa]	Qv [m³/h]	Δp [Pa]	Qv [m³/h]	Δp [Pa]
1	0	0,0	0	0,0	0	0,0	0	0,0	0	0,0	0	0,0
2	50	0,4	50	0,4	50	0,6	50	0,6	50	0,8	50	0,9
3	100	1,7	100	1,6	100	2,5	100	2,3	100	3,2	100	3,7
4	150	3,8	150	3,5	150	5,6	150	5,2	150	7,2	150	8,4
5	200	6,7	200	6,3	200	9,9	200	9,2	200	12,7	200	15,0
6	250	10,5	250	9,8	250	15,5	250	14,5	250	19,9	250	23,4
7	300	15,1	300	14,1	300	22,3	300	20,8	300	28,6	300	33,7
8	350	20,5	350	19,2	350	30,3	350	28,3	350	38,9	350	45,8
9	400	26,8	400	25,1	400	39,6	400	37,0	400	50,9	400	59,8
10	450	33,9	450	31,7	450	50,2	450	46,8	450	64,4	450	75,7
11	500	41,8	500	39,2	500	61,9	500	57,8	500	79,5	500	93,5
12	600	60,2	600	56,4	600	89,2	600	83,2	600	114,5	600	134,6
13	700	82,0	700	76,8	700	121,4	700	113,3	700	155,8	700	183,3
14	800	107,1	800	100,2	800	158,5	800	148,0	800	203,5	800	239,4

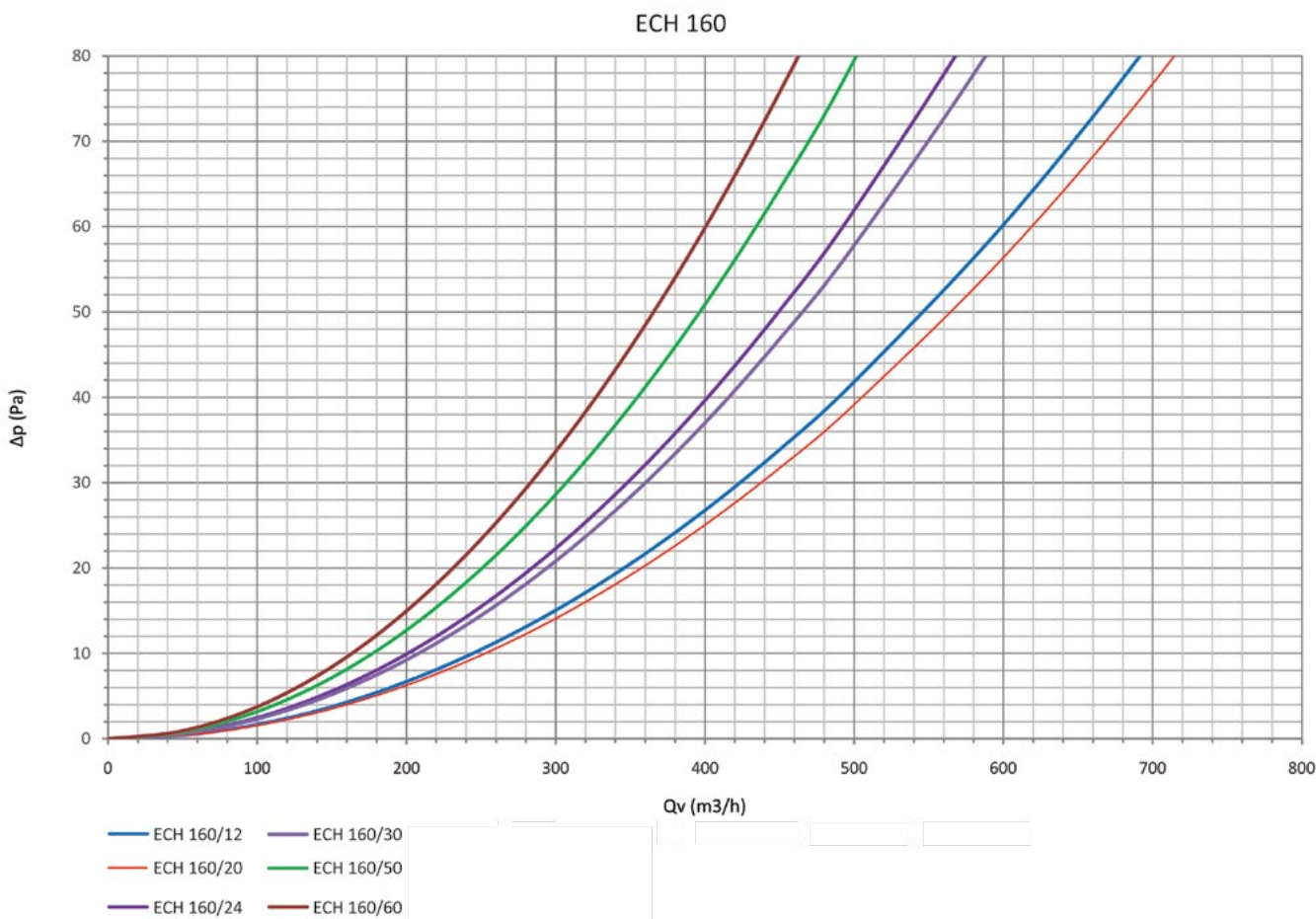

# ECH 200/.../1f

Air temperature: 18 °C

No.	ECH 200/12		ECH 200/20		ECH 200/24		ECH 200/30		ECH 200/50		ECH 200/60	
	Qv [m³/h]	Δp [Pa]	Qv [m³/h]	Δp [Pa]	Qv [m³/h]	Δp [Pa]	Qv [m³/h]	Δp [Pa]	Qv [m³/h]	Δp [Pa]	Qv [m³/h]	Δp [Pa]
1	0	0,0	0	0,0	0	0,0	0	0,0	0	0,0	0	0,0
2	50	0,1	50	0,1	50	0,1	50	0,1	50	0,2	50	0,2
3	100	0,3	100	0,4	100	0,5	100	0,5	100	0,7	100	0,8
4	150	0,8	150	0,8	150	1,2	150	1,2	150	1,7	150	1,7
5	200	1,4	200	1,4	200	2,1	200	2,1	200	3,0	200	3,1
6	250	2,1	250	2,3	250	3,2	250	3,3	250	4,7	250	4,8
7	300	3,1	300	3,3	300	4,7	300	4,8	300	6,7	300	6,9
8	350	4,2	350	4,4	350	6,3	350	6,5	350	9,1	350	9,4
9	400	5,4	400	5,8	400	8,3	400	8,5	400	11,9	400	12,3
10	450	6,9	450	7,3	450	10,5	450	10,8	450	15,1	450	15,6
11	500	8,5	500	9,0	500	13,0	500	13,3	500	18,6	500	19,2
12	600	12,2	600	13,0	600	18,7	600	19,2	600	26,8	600	27,7
13	800	21,8	800	23,1	800	33,2	800	34,2	800	47,7	800	49,3
14	1000	34,0	1000	36,1	1000	51,8	1000	53,4	1000	74,5	1000	77,0

ECH 200

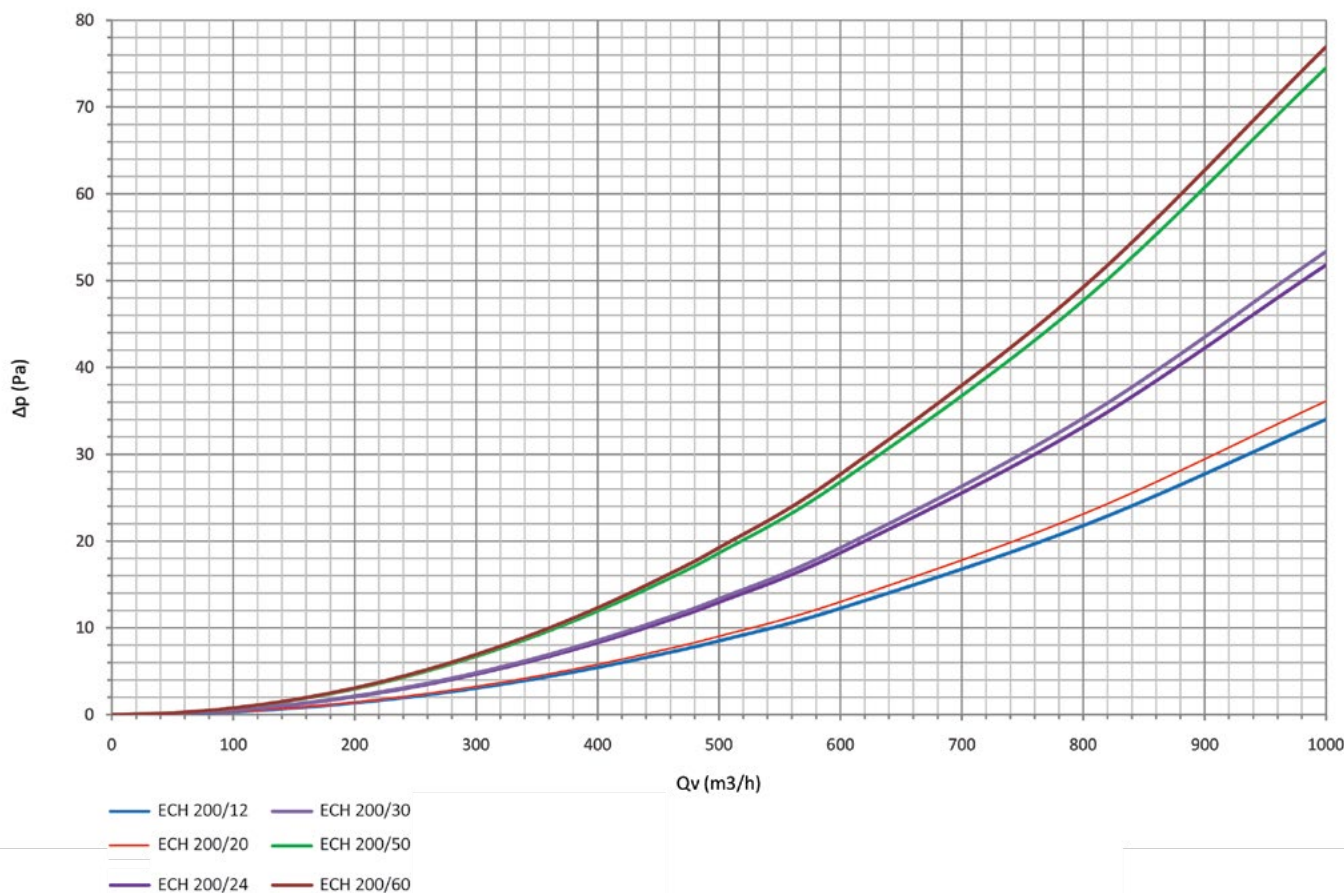

## ECH 250

Air temperature: 18 °C

No.	ECH 250/12 1f		ECH 250/20 1f		ECH 250/24 1f		ECH 250/30 2f		ECH 250/50 2f		ECH 250/60 2f		ECH 250/60 3f		ECH 250/90 3f	
	Qv [m³/h]	Δ [Pa]	Qv [m³/h]	Δ [Pa]	Qv [m³/h]	Δ [Pa]	Qv [m³/h]	Δ [Pa]	Qv [m³/h]	Δ [Pa]	Qv [m³/h]	Δ [Pa]	Qv [m³/h]	Δ [Pa]	Qv [m³/h]	Δ [Pa]
1	0,0	0,0	0,0	0,0	0,0	0,0	0,0	0,0	0,0	0,0	0,0	0,0	0,0	0,0	0,0	0,0
2	50	0,0	50	0,0	50	0,0	50	0,0	50	0,0	50	0,1	50	0,0	50	0,1
3	100	0,1	100	0,1	100	0,1	100	0,1	100	0,2	100	0,2	100	0,2	100	0,3
4	200	0,2	200	0,3	200	0,4	200	0,4	200	0,7	200	0,8	200	0,7	200	1,1
5	400	0,9	400	1,3	400	1,5	400	1,7	400	2,7	400	3,3	400	2,7	400	4,3
6	600	2,1	600	2,8	600	3,4	600	3,9	600	6,0	600	7,4	600	6,1	600	9,6
7	800	3,7	800	5,0	800	6,1	800	7,0	800	10,6	800	13,1	800	10,9	800	17,1
B	1000	5,7	1000	7,8	1000	9,5	1000	10,9	1000	16,6	1000	20,5	1000	17,0	1000	26,8
9	1200	8,3	1200	11,3	1200	13,7	1200	15,7	1200	23,9	1200	29,6	1200	24,5	1200	38,6
10	1400	11,2	1400	15,3	1400	18,7	1400	21,3	1400	32,5	1400	40,2	1400	33,4	1400	52,5
11	1600	14,7	1600	20,0	1600	24,4	1600	27,9	1600	42,4	1600	52,6	1600	43,6	1600	68,6
12	2000	22,9	2000	31,3	2000	38,1	2000	43,5	2000	66,3	2000	82,1	2000	68,1	2000	107,2
13	2400	33,0	2400	45,0	2400	54,9	2400	62,7	2400	95,4	2400	118,3	2400	98,0	2400	154,3
14	3000	51,6	3000	70,4	3000	85,8	3000	97,9	3000	149,1	3000	184,8	3000	153,2	3000	241,1

ECH 250

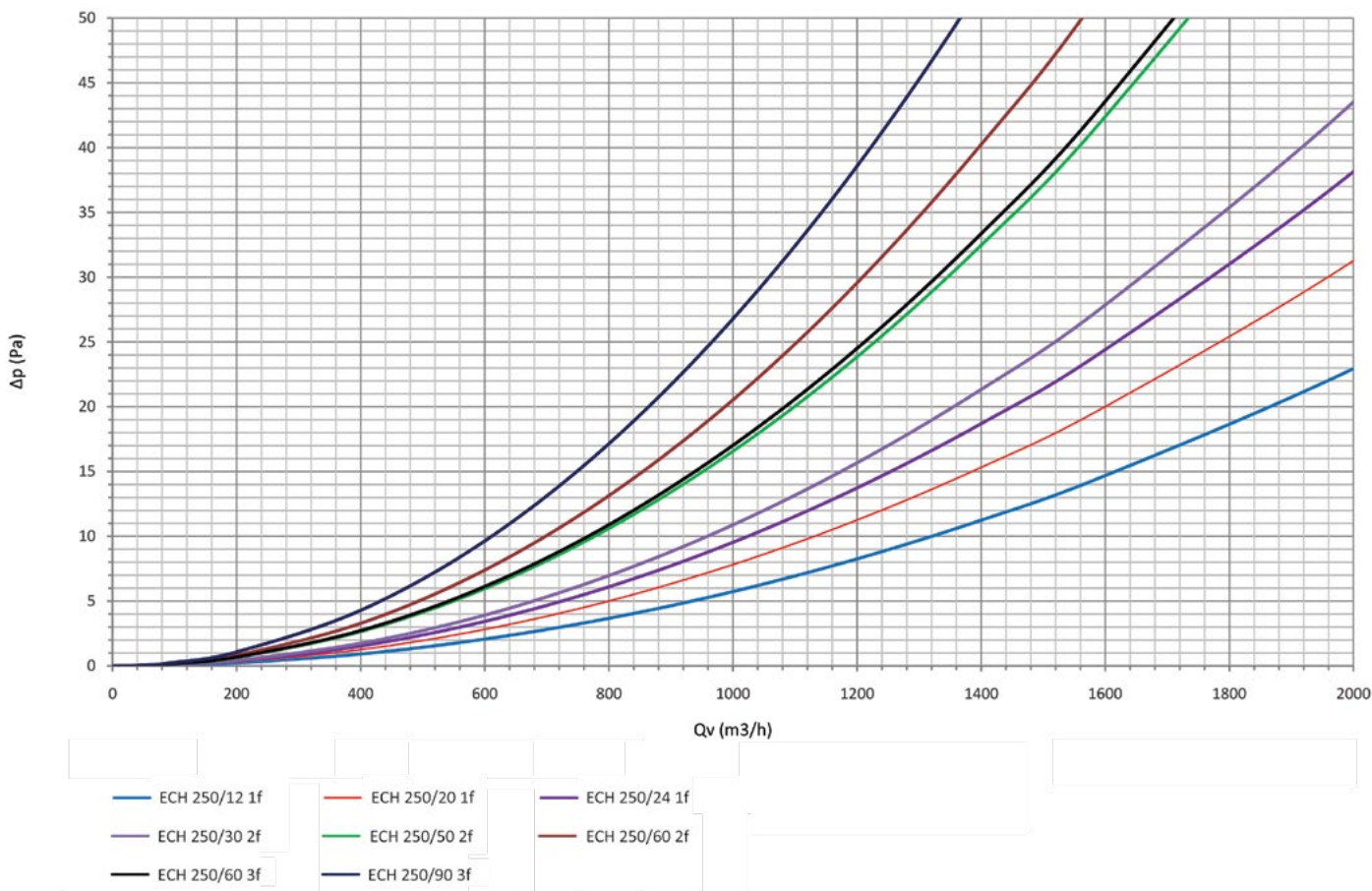

## ECH 315

Air temperature: 18 °C

No.	ECH 315/20 1f		ECH 315/30 2f		ECH 315/60 2f		ECH 315/90 3f		ECH 315/120 3f	
	Qv [m³/h]	Δp [Pa]	Qv [m³/h]	Δp [Pa]	Qv [m³/h]	Δp [Pa]	Qv [m³/h]	Δp [Pa]	Qv [m³/h]	Δp [Pa]
1	0,0	0,0	0,0	0,0	0,0	0,0	0,0	0,0	0,0	0,0
2	50	0,0	50	0,0	50	0,0	50	0,0	50	0,0
3	100	0,0	100	0,0	100	0,1	100	0,1	100	0,1
4	200	0,1	200	0,1	200	0,2	200	0,3	200	0,4
5	400	0,3	400	0,5	400	1,0	400	1,1	400	1,4
6	600	0,8	600	1,1	600	2,1	600	2,4	600	3,2
7	800	1,4	800	2,0	800	3,8	800	4,2	800	5,6
8	1000	2,2	1000	3,1	1000	6,0	1000	6,6	1000	8,8
9	1200	3,1	1200	4,5	1200	8,6	1200	9,5	1200	12,6
10	1400	4,2	1400	6,1	1400	11,7	1400	12,9	1400	17,2
11	1600	5,5	1600	8,0	1600	15,3	1600	16,9	1600	22,5
12	2000	8,6	2000	12,5	2000	23,9	2000	26,4	2000	35,1
13	2400	12,4	2400	18,0	2400	34,3	2400	38,0	2400	50,6
14	3000	19,4	3000	28,1	3000	53,7	3000	59,4	3000	79,0

ECH 315

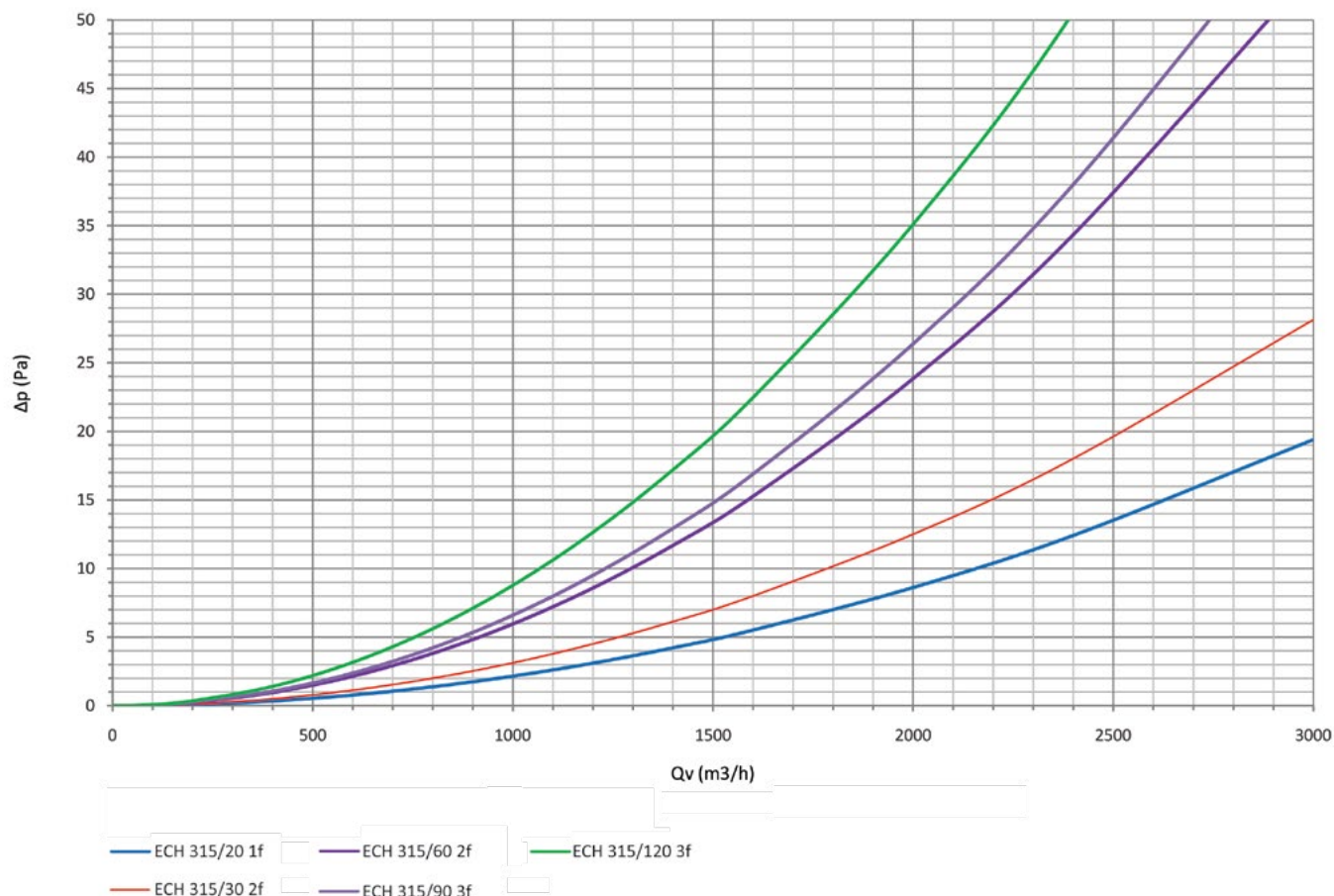



## ECH 400

Air temperature: 18 °C

No.	ECH 400/30 1f		ECH 400/50 2f		ECH 400/60 2f		ECH 400/90 3f		ECH 400/120 3f	
	Qv [m³/h]	Δp [Pa]	Qv [m³/h]	Δp [Pa]	Qv [m³/h]	Δp [Pa]	Qv [m³/h]	Δp [Pa]	Qv [m³/h]	Δp [Pa]
1	0,0	0,0	0,0	0,0	0,0	0,0	0,0	0,0	0,0	0,0
2	200	0,0	200	0,0	200	0,1	200	0,1	200	0,1
3	400	0,1	400	0,2	400	0,2	400	0,3	400	0,4
4	600	0,3	600	0,4	600	0,6	600	0,7	600	0,9
5	800	0,5	800	0,7	800	1,0	800	1,2	800	1,6
6	1000	0,8	1000	1,0	1000	1,5	1000	1,8	1000	2,6
7	1500	1,8	1500	2,3	1500	3,5	1500	4,1	1500	5,7
8	2000	3,1	2000	4,1	2000	6,2	2000	7,3	2000	10,2
9	2500	4,9	2500	6,4	2500	9,7	2500	11,4	2500	15,9
10	3000	7,1	3000	9,2	3000	13,9	3000	16,4	3000	23,0
11	3500	9,6	3500	12,5	3500	18,9	3500	22,3	3500	31,2
12	4000	12,6	4000	16,3	4000	24,7	4000	29,1	4000	40,8
13	4500	15,9	4500	20,7	4500	31,3	4500	36,8	4500	51,7
14	5000	19,7	5000	25,5	5000	38,7	5000	45,5	5000	63,8

ECH 400

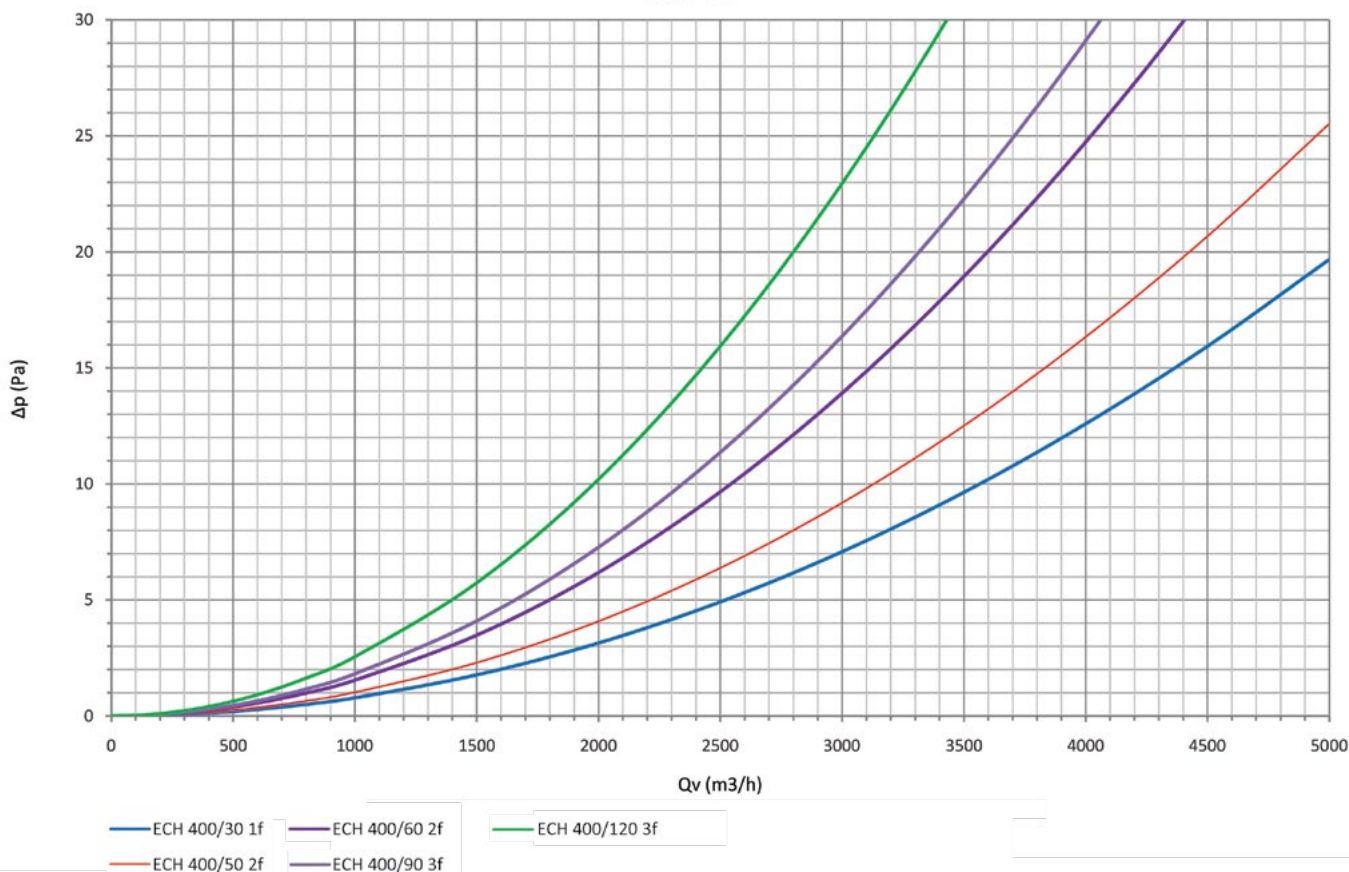

## ECH 500

Air temperature: 18 °C

No.	ECH 500/60 1f	
	Qv [m³/h]	Δp [Pa]
1	0	0,0
2	500	0,1
3	1000	0,3
4	1500	0,7
5	2000	1,2
6	2500	1,9
7	3000	2,7
8	3500	3,7
9	4000	4,8
10	4500	6,1
11	5000	7,6
12	5500	9,1
13	6000	10,9
14	8000	19,4

ECH 500

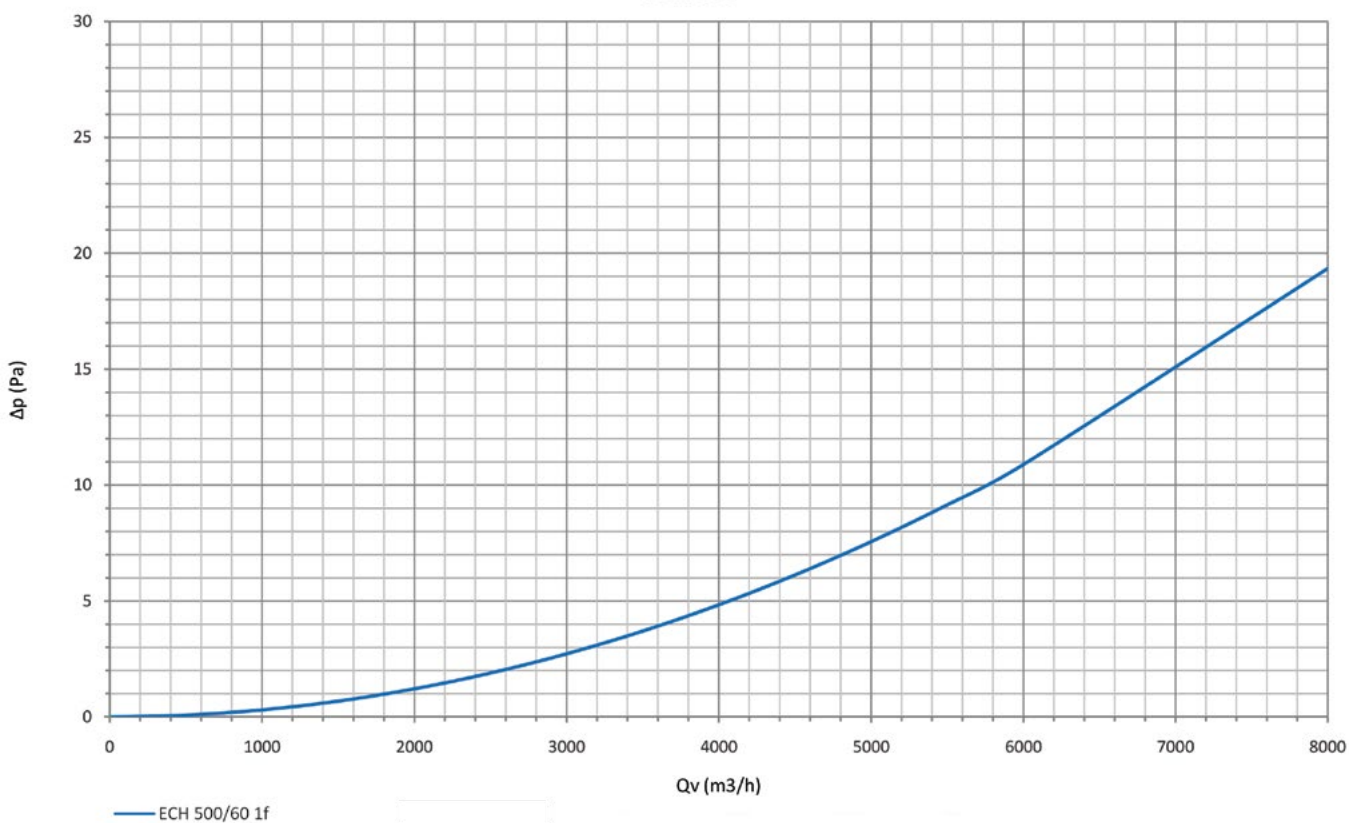



## Electric heaters ERH



Steel cover with aluzinc coating



Two-stage overheating protection



IP 44 protection class

### Description

ERH is an electric duct heater **without built-in automation**. The heating power of the heater can be adjusted via an external HRK controller. ERH heaters are designed for installation in rectangular ducts. Heating power range: 6.0 to 66.0 kW.

Each heater has a two-stage overheating protection:

I stage at 50°C - automatic reset.

II stage at 100°C – manual reset required.

### Usage

Duct heaters are used to heat clean air in domestic ventilation systems, especially in autumn and winter, as well as in industrial installations requiring a constant temperature of blown air.

ECH heaters also work as pre-heaters or secondary heaters, complementing installations based on ventilation units with heat recovery.

### Design

The heater cover is made of steel sheet coated with a high-quality aluzinc coating, which guarantees high corrosion resistance.

The heating elements are made of AISI 304 stainless steel.

The junction box has an IP44 protection class.

### Power of heating elements

Power [kW]	Heating elements [kW]	Power [kW]	Heating elements [kW]
9	9	36	9+12+15
12	12	39	9+15+15
15	15	42	12+15+15
18	9+9	45	12+15+18
21	9+12	51	9+12+12+18
24	9+15	54	9+12+15+18
27	12+15	60	12+15+15+18
30	15+15	66	15+15+18+18
33	15+18	-	-

### Accessories



#### PSH

Pressure switch  
page 173



#### TJK10K

Duct temperature sensor  
page 173



#### HRK3

Three-phase heater controller  
page 174



#### HR5K

External temperature setpoint  
page 174

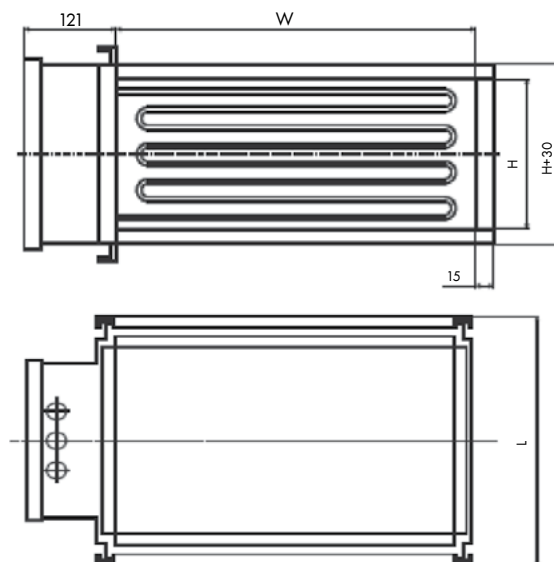

Standard dimensions [mm]

ERH-4020; WxH = 400x200

Length L	mm	370	420	520		
Power	kW	6	9	12	15	21

ERH-5025; WxH = 500x250

Length L	mm	370	420	520	600	820	970	
Power	kW	9	12	15	21	24	36	45

ERH-5030; WxH = 500x300

Length L	mm	370	440	520	600								
Power	kW	9	12	15	18	21	24	27	30	33	36	42	45

ERH-6030; WxH = 600x300

Length L	mm	370	440	520	600								
Power	kW	9	12	15	18	21	24	27	30	33	36	42	45

ERH-6035; WxH = 600x350

Length L	mm	370	420	500										
Power	kW	9	12	15	18	21	24	27	30	33	36	39	42	45

ERH-7040; WxH = 700x400

Length L	mm	370	440	520												
Power	kW	9	12	15	18	21	24	27	30	33	36	42	45	51	60	66

ERH-8050; WxH = 800x500

Length L	mm	370	420	440	500													
Power	kW	9	12	15	18	21	24	27	30	33	36	39	42	45	51	54	60	66

ERH-10050; WxH = 1000x500

Length L	mm	370	420	440	500													
Power	kW	9	12	15	18	21	24	27	30	33	36	39	42	45	51	54	60	66

\*Other dimensions and heating powers are available on request.





## Electric heaters ERH NV/NI/NIS



Steel cover with aluzinc coating



Two-stage overheat protection



Integrated automatic



IP 44 protection class

### Description

ERH NI/NV/NIS is a series of electric duct heaters with a **built-in automation system containing a heater power regulator**. The adjustment is performed by pulsation. The time between switching the heaters on and off is adjusted by the regulator to ensure that the set temperature is maintained. The NV/NI/NIS series differ in the way the target value is set:

**NI** – Temperature setpoint using potentiometer located on heater cover.

**NV** – Temperature setting using HR5K external setpoint.

**LOW** – Temperature setting using external control signal 0 - 10 V.

ERH heaters are designed for installation in rectangular ducts. Heating power range: 6.0 to 66.0 kW.

Each heater has a two-stage overheat protection:

I level at 50°C - automatic reset.

II level at 100°C – manual reset required.

### Usage

Duct heaters are used to heat clean air in domestic ventilation systems, especially in autumn and winter, as well as in industrial installations requiring a constant temperature of blown air.

ECH heaters also work as pre-heaters or secondary heaters, complementing installations based on ventilation units with heat recovery.

### Design

The heater cover is made of steel sheet coated with a high-quality aluzinc coating, which guarantees high corrosion resistance.

The heating elements are made of AISI 304 stainless steel.

The junction box has an IP44 protection class.

### Power of heating elements

Power [kW]	Heating elements [kW]	Power [kW]	Heating elements [kW]
9	9	36	9+12+15
12	12	39	9+15+15
15	15	42	12+15+15
18	9+9	45	12+15+18
21	9+12	51	9+12+12+18
24	9+15	54	9+12+15+18
27	12+15	60	12+15+15+18
30	15+15	66	15+15+18+18
33	15+18	-	-

### Accessories



#### PSH

Pressure switch  
page 173



#### TJK10K

Duct temperature sensor  
page 173



#### HR5K

External temperature setpoint  
page 174

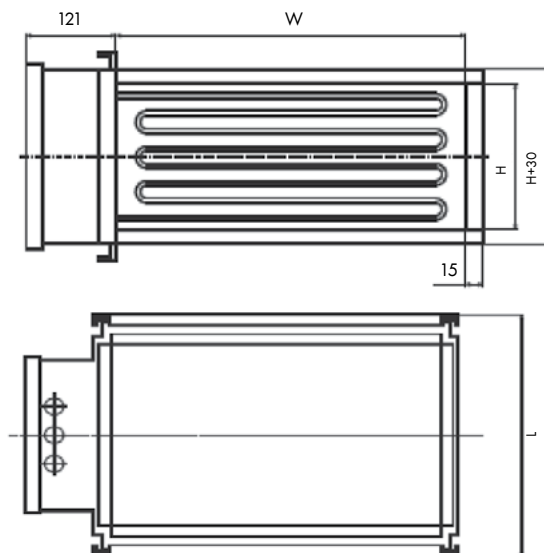

Standard dimensions [mm]

ERH NI/NV/NIS-4020; WxH = 400x200

Length L	mm	370	420	520		
Power	kW	6	9	12	15	21

ERH NI/NV/NIS-5025; WxH = 500x250

Length L	mm	370	420	520	600	820	970	
Power	kW	9	12	15	21	24	36	45

ERH NI/NV/NIS-5030; WxH = 500x300

Length L	mm	370	440	520	600								
Power	kW	9	12	15	18	21	24	27	30	33	36	42	45

ERH NI/NV/NIS-6030; WxH = 600x300

Length L	mm	370	440	520	600								
Power	kW	9	12	15	18	21	24	27	30	33	36	42	45

ERH NI/NV/NIS-6035; WxH = 600x350

Length L	mm	370	420	500										
Power	kW	9	12	15	18	21	24	27	30	33	36	39	42	45

ERH NI/NV/NIS-7040; WxH = 700x400

Length L	mm	370	440	520												
Power	kW	9	12	15	18	21	24	27	30	33	36	42	45	51	60	66

ERH NI/NV/NIS-8050; WxH = 800x500

Length L	mm	370	420	440	500													
Power	kW	9	12	15	18	21	24	27	30	33	36	39	42	45	51	54	60	66

ERH NI/NV/NIS-10050; WxH = 1000x500

Length L	mm	370	420	440	500													
Power	kW	9	12	15	18	21	24	27	30	33	36	39	42	45	51	54	60	66



## Pressure switch PSH

### Description

The differential pressure sensor informs about a decrease in air flow due to a pressure difference, e.g.: a dirty filter or a defective fan, protects against overheating of electric heaters, regulation and protection in fire protection systems, protection against frost of heat exchangers. Connection cable, switching potential-free contacts.

### Technical drawing

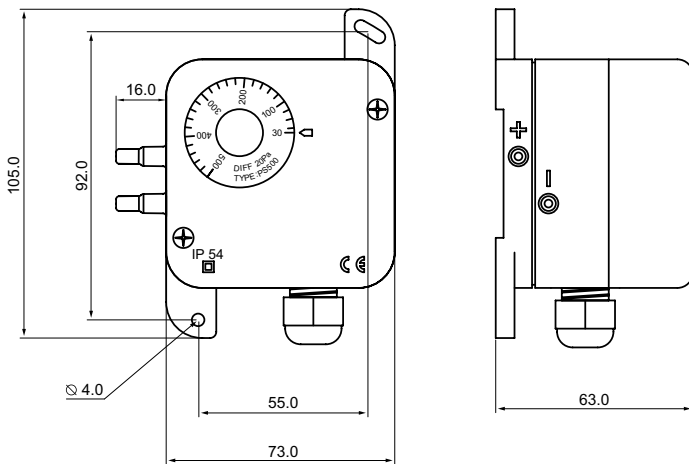

### Technical specifications

<b>Operating range</b>	PSH 300: 30 - 300 Pa PSH 600: 40 - 600 Pa
<b>Measurement accuracy</b>	±8 Pa at low limit, ±15% at high limit
<b>Switching difference</b>	PSH 300: 25 Pa PSH 600: 35 Pa
<b>Maximum operating pressure</b>	50 kPa
<b>Temperature range</b>	operating temperature: -20°C ... +60°C storage temperature: -20°C ... +85°C
<b>Air humidity</b>	0...95% (relative, without condensation)
<b>Dimensions (w x h x dpt)</b>	90 x 105 x 63 mm
<b>Weight</b>	150 g
<b>Protection class</b>	IP54
<b>Connections</b>	male connector Ø 5,0 mm
<b>Electrical connections</b>	3 screw terminals (0,2 - 1,5 mm <sup>2</sup> )
<b>Power supply</b>	250 VAC, 3 A (rez.), 2 A (ind.)

NOTE: Standard equipment includes a 2-metre PVC hose and 2 plastic connectors.

### The installation of the device

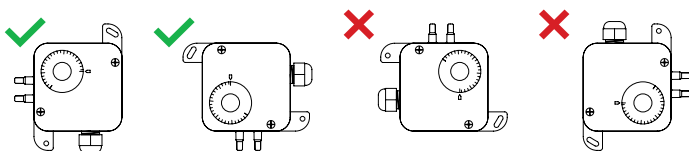

## Duct temperature sensor TJK10K



### Description

A duct temperature sensor, equipped with a NTCK10 thermistor (10 kΩ resistance at 25°C) for excellent temperature stability. The measuring element was built in a special tube made of plastic. The depth of the sensor installation in the duct can be adjusted according to the needs thanks to the movable mounting flange. Protection class IP20, cable length 1.5 m.

### Technical specifications

<b>Operating range</b>	-30°C...+105°C
<b>Length</b>	1500 mm (tube 200 mm)
<b>Diameter</b>	7,5 mm

## Single- or two-phase heater controller HRK1



### Description

HRK 1 is a microprocessor-based PID controller, designed to work only with electric heaters with a power supply of 1~230V and 2~400V (2-phase). Do not use the HRK controller to regulate the operation of electric motors, lighting and heaters with a power supply of 3~400V (3-phase). The controller is equipped with an automatic voltage detection function. The time between switching the heater on and off is automatically adjusted by the controller to maintain the set temperature. The controller has a built-in temperature sensor, but it can also work with external sensors. The air temperature value can be limited to the minimum and maximum values - this requires the connection of 2 external sensors according to the diagram. HRK1 automatically detects the connected sensors and selects the appropriate operating mode. The controller has a night mode, which allows it to reduce the set temperature by 0...10°C. This function requires an external timer. HRK1 has an angle sensor between phase and zero to protect against RFI interference.

### Technical specifications

<b>Maximum adjustable load [kW]</b>	6,4/400V ; 3,2/230V
<b>Minimum adjustable load [kW]</b>	0,4/400V ; 0,23/230V
<b>Maximum adjustable current [A]</b>	16
<b>Minimum adjustable current [A]</b>	1
<b>Voltage [V]</b>	230 - 415
<b>Frequency [Hz]</b>	50 - 60
<b>Phases</b>	1~230V / 2~400V
<b>Dimensions [mm]</b>	150 x 80 x 45
<b>Protection class</b>	IP20
<b>Room temperature [°C]</b>	30 max.
<b>Ambient humidity</b>	90% max
<b>Ambient temperature [°C]</b>	0 - 30



## Three-phase heater controller HRK3

### Description

HRK3 is a microprocessor-based power controller of the electric heater. Do not use the HRK3 controller to adjust the operation of electric motors and lighting. HRK3 allows you to adjust the heater with a power of up to 15kW. In addition, the regulator has a relay output with a contactor, allowing it to connect a load of 12 kW. The total allowable load of the controller is 27 kW.

HRK3 automatically adjusts the control mode to match the dynamics of the subject. In case of rapid temperature changes, e.g. ventilation temperature control, the controller will work as a PI (proportional-integral) type regulator. For slow temperature changes, e.g. room temperature control, the controller will operate as a P (proportional) regulator. The controller has a night mode, which allows it to lower the set temperature by 0..10°C. This function requires an external timer.

### Technical specifications

Maximum adjustable load [kW]	15
Extra adjustable load [kW]	12
Total adjustable load [kW]	27
Maximum adjustable current [A]	25
Voltage [V]	3x230 / 3x400
Frequency [Hz]	50 - 60
Phases	3~
Dimensions [mm]	105 x 260 x 120
Fuse [A]	2 x 0,315
Protection class	IP20
Room temperature [°C]	0 - 40
Ambient humidity	90% max
Heat dissipation [W]	50



## External temperature setpoint HR5K

### Description

The HR5K external temperature setpoint can be used with HRK1 and HRK3 controllers as a remote temperature setting point. HR5K is used when the installation of the regulator in a given location is impossible for safety, aesthetic or other reasons resulting from the design. Surface-mounted.

### Technical specifications

Potentiometer	5 kΩ
Setting range	0..30°C
Protection class	IP20
Dimensions [H x W x Dpt]	71 x 71 x 25 mm

## Electrical room thermostat HTS



### Description

The thermostat can be used to adjust both heating and cooling. Temperature measurement by internal or external sensor. Selectable set point range and sensor hysteresis.

The external temperature sensor must be purchased separately.

### Technical specifications

Input voltage	230V
Relay output	6A / 230V
Cycles	60000
Hysteresis	1..3°C
Adjustment range	0..30°C lub 0..60°C
External temperature sensor	TJK 10K (NTC 10K 10kΩ @ 25°C)
Insulation class	II
Protection class	IP20
Cover material	Material from group IIIa
Dimensions (H x W x Dpt)	71 x 71 x 25 mm
Ambient humidity	90% max
Heat dissipation [W]	50

## Electronic speed controller HRX



### Description

The electronic fan speed controller for single-phase motors enables smooth adjustment of the efficiency of the control panel or a fan. Surface or flush mounting possible.

### Technical drawing

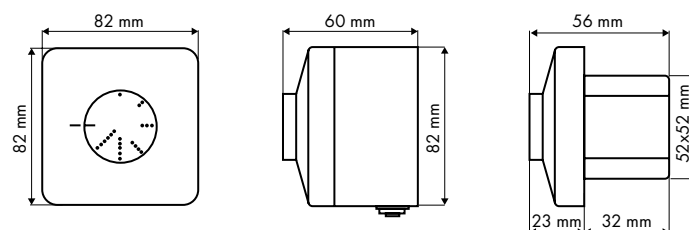

### Technical specifications

Model	Voltage [V]	Current [A]	Weight [kg]
HRX 1.0	1x230	1,0	0,32
HRX 2.5	1x230	2,5	0,32
HRX 4.0	1x230	4,0	0,32



## Potentiometer for EC motors HMTP

### Description

The HMTP potentiometer has been developed to control devices that need a stageless control signal. Supply voltage range 0–12 VDC. The output voltage is infinitely adjustable from 0 to the supply voltage ( $U_s$ ) by a knob. It is equipped with a switch (potential-free contact) for remote switching on/off of external devices. The potentiometer is suitable for flush mounting (IP44) and surface mounting (IP54).

### Technical specifications

Supply voltage ( $U_s$ )	max. 12 VDC / 1 mA
Output	0– $U_s$
Contact switch rating	4 A (250 VAC) 10 A / 12 VDC
Protection class	IP44 / IP54 (according to EN 60529)
Environmental conditions	Temperature 0–50 °C Humidity <95 % rH (non-condensing)

### Connections



$U_s$	Supply voltage (0–12 VDC)
+	Output voltage (0– $U_s$ )
-	Grounding
$\sigma_1$	Non-voltage contact for remote ON/OFF of external devices
Connections	Cable cross-section: max. 2,5 mm <sup>2</sup>

### Technical drawing

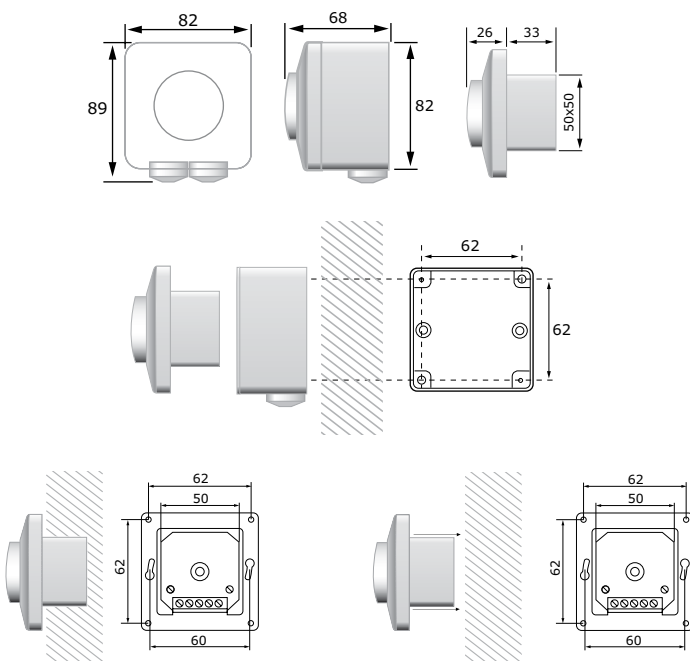

## Speed controller for EC motors RS-EC



### Description

The controller is designed for smooth control of fans with EC motors. Quick connection of the fan with the controller via the “Jack” plug. Flush mounting possible.

### Technical drawing

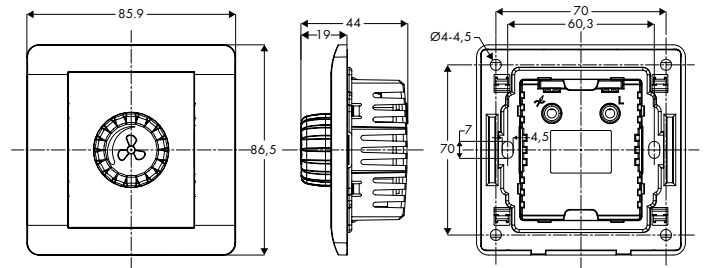

### Technical specifications

Model	Control voltage [V]	Weight [kg]
Regulator RS-EC	0 - 10	0,1

## Single-phase motor gear switch HRS

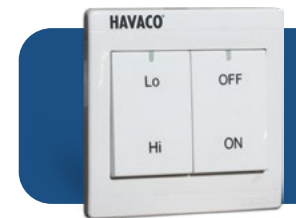

### Description

The gear switch is designed to control the speed of fans with two-speed single-phase motors. Operating status: on/off and first/second gear.

### Technical specifications

Model	Voltage [V]	Max. current [A]	Weight [kg]
HRS-01	230	10	0,1

### Technical drawing

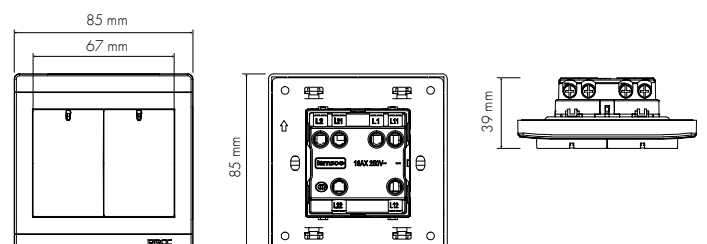



## Transformer speed controller HRB

### Description

Transformer controllers are adapted to change the motor speed by changing the voltage. The controllers have a function to protect against overheating of the transformer. All regulators have a 230 VAC output to connect actuators, heaters, relays, integrating the work of accessories with the work of the fan. More than one fan may be connected to a single controller, provided that the total current of all motors does not exceed the maximum permissible value of the controller.

### Technical drawing

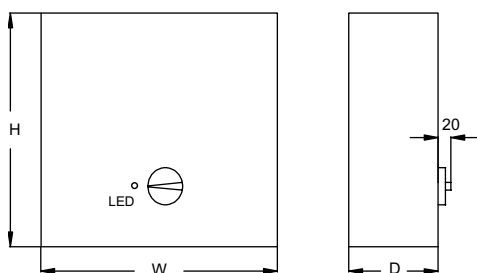

### Technical specifications

Model	Voltage [V]	Max. current [A]	Weight [kg]	Dimensions HxWxD [mm]
HRB 1	1x230	1,0	1,9	165x120x79
HRB 1,5	1x230	1,5	2,6	165x120x79
HRB 2	1x230	2,0	3,0	170x145x93
HRB 3	1x230	3,0	3,5	170x145x93
HRB 4	1x230	4,0	4,4	178x155x150
HRB 5	1x230	5,0	4,9	178x155x150
HRB 7	1x230	7,0	7,3	244x184x178

Number of regulation steps	5
Power supply	1x230 VAC
Frequency	50-60 Hz
Voltage values	80V $I_{max} * 0,6$ ; 120V $I_{max} * 0,8$ ; 140V $I_{max} * 1$ ; 170V $I_{max} * 1$ ; 230V $I_{max} * 1$
Protection class	IP44
Max. ambient temperature	40 °C
Max. allowable temperature	T = 130 °C – ambient temperature. Max. transformer temperature 70 °C, limited by thermal protection of the transformer.

## Transformer speed controller HRC/HRT

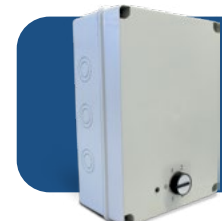

### Description

Transformer controllers are adapted to change the motor speed by changing the voltage. The controllers have a function to prevent overheating of both the motor and the transformer. All controllers have a 230 VAC output to connect actuators, heaters, relays, integrating the work of accessories with the work of the fan. More than one fan may be connected to a single controller, provided that the total current of all motors does not exceed the maximum permissible value of the controller.

The 3-phase motor regulators are protected against power loss. When the power is restored, the controller will not return to the selected gear – the controller must be switched off and on again.

### Technical drawing

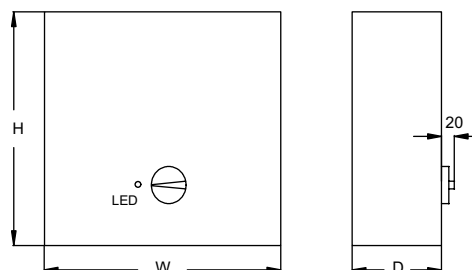

### Technical specifications

Model	Voltage [V]	Max. current [A]	Weight [kg]	Dimensions HxWxD [mm]
HRC 1,5	1x230	1,5	2,6	178x155x99
HRC 2	1x230	2,0	3,0	178x155x99
HRC 3	1x230	3,0	3,5	178x155x99
HRC 4	1x230	4,0	4,4	178x155x150
HRC 5	1x230	5,0	4,9	178x155x150
HRC 7	1x230	7,0	7,3	244x184x178
HRC 11	1x230	11,0	9,5	244x184x178
HRC 14	1x230	14,0	10,4	244x184x178
HRT 1	3x400	1,0	6,3	335x245x133
HRT 2	3x400	2,0	8,1	335x245x133
HRT 3	3x400	3,0	10,7	335x245x133
HRT 4	3x400	4,0	14,6	335x245x133
HRT 5	3x400	5,0	18,7	300x290x160
HRT 7	3x400	7,0	24,7	365x320x190
HRT 11	3x400	11,0	34,1	365x320x190
HRT 14	3x400	14,0	37,2	365x320x190

Number of regulation steps	5
Power supply	HRC - 1x230 VAC, HRT – 3x400 VAC
Frequency	50-60 Hz
Voltage values	80V $I_{max} * 0,6$ ; 120V $I_{max} * 0,9$ ; HRC: 140V $I_{max} * 1$ ; 170V $I_{max} * 1$ ; 230V $I_{max} * 1$ ; 130V $I_{max} * 0,9$ ; 170V $I_{max} * 1$ ; HRT: 220V $I_{max} * 1$ ; 270V $I_{max} * 1$ ; 400V $I_{max} * 1$
Protection class	IP44
Max. ambient temperature	40 °C



## Service switch WSH

### Description

The service switch WSH is designed for fans and HVAC devices (e.g. roof fans, duct fans, box fans, ventilation units, etc.). The WSH switch is equipped with additional contacts (NO and NC). Mounting method - surface-mounted. KD rubber grommets (seals) available as additional accessories. IP 65 protection class.

### Product code

Product code	Operating current AC21A*	Output power 400 VAC/AC3*	Poles	NO contact	NC contact
WSH 20	20 A	5,5 kW	4	1	1

\* Reminder:

AC21A - Switching of resistive loads, including small loads.

AC3 - Electric motors with a squirrel-cage rotor: starting, stopping, control.

### Technical drawing [mm]

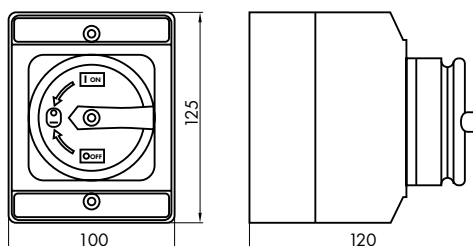

### Main characteristics:

- 90° switching angle.
- Easy to connect through M20 holes.
- Clamping screws in open position.
- Triple "off" position with padlock protection.

### Technical specifications

<b>Protection class</b>	IP65 (according to EN 60529)
<b>Environmental conditions</b>	Temperature: ≤ 20 - 40 °C
	Humidity: 50% rH (at +40 °C)
	≤ 90% rH (at +20 °C) non-condensing
<b>Regulations</b>	

### Electrical connection

	14	22	1/L1	3/L2	5/L3	N
○ OFF	13	21	2/T1	4/T2	6/T3	N
		×				
I ON	×		×	×	×	×

### Switch diagram







## Rubber gland KD

### Description

KD is a general purpose grommet for tight connection of cables with service switches WSH, etc., protection class IP67. They are made of high quality rubber resistant to dust and solvents. Metric size M20.

### Technical drawing [mm]

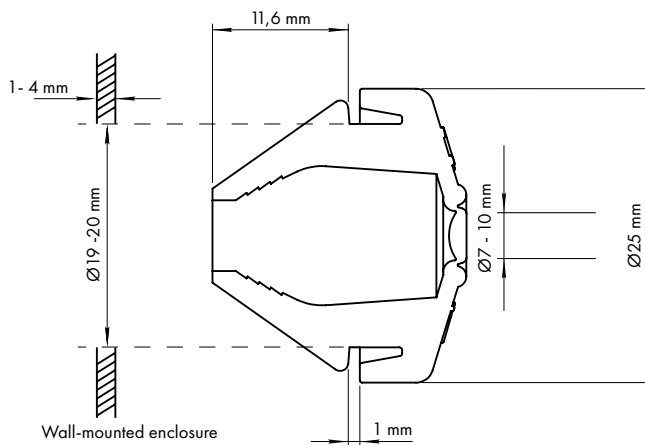

### Technical specifications

<b>Material</b>	TPV rubber
<b>Protection class</b>	IP67 (according to EN 60529)
<b>Temperature range</b>	-60 - 135 °C
<b>Sealing range</b>	7 - 10 mm
<b>Colour</b>	Grey (RAL 7035)
<b>Regulations</b>	Directive RoHS 2017/2102 / UE 



# Insulated copper pipe HAVACO ColdLine Pro



Easy assembly



High quality



Resistant to UV radiation



Fire resistance  
BL S1 d0

## Description

High quality copper pipe made in accordance with EN 12735-1, intended for distribution of refrigerants R410A, R407C and R32. Easy to install, saves time when installing air conditioning/cooling systems. Effectively prevents condensation. Resistant to UV radiation, protected against mechanical damage.

## Copper pipe

<b>Material:</b>	Copper alloy C12200 Cu-DHP, phosphorus-deoxidized, hardened, in coils
<b>Chemical composition:</b>	Cu ≥ 99,90%; maximum allowable amount of phosphorus = 0,015% ÷ 0,040%.

## Dimensions [mm]:

Outer diameter	Outer diameter	Wall thickness	Insulation thickness	Coil length
1/4"	6,35	0,8	6,5	25/50 m
3/8"	9,52	0,8	7	25/50 m
1/2"	12,7	0,8	10	25/50 m
5/8"	15,87	1	10	25/50 m
3/4"	19,05	1	10	25 m
7/8"	22,22	1	10	25 m

## Polyethylene foam insulation

Polyethylene foam provides thermal insulation from the environment.

<b>Low density polyethylene foam:</b>	Insulation made of low density polyethylene foam, closed cells, free from chlorofluorocarbons (CFCs) and hydrochlorofluorocarbons (HCFCs) in accordance with the European standard CEE/EU 2037/2000.
<b>Thermal conductivity:</b>	0.0397 W/MK (at 40°C) according to UNI EN ISO 8497.
<b>Operating temperature:</b>	Polyethylene foam insulation ensures correct operation at 5 ÷ 95°C.
<b>Insulation material density:</b>	30 kg/m <sup>3</sup>
<b>Outer protection:</b>	The polyethylene shield provides protection from external damage.
<b>Color:</b>	Standard white color
<b>Insulation thickness:</b>	Adequate insulation thickness prevents condensation of water under normal operating conditions: fluid temperature in the pipe higher than or equal to 7°C, indoor temperature 27°C, indoor relative humidity lower or equal to 50%, in accordance with EN 14111 and UNI 10376 (1994)
<b>Fire resistance:</b>	Class 1 according to DM 26/06/1984, converted to DM 3/09/2001.  EUROCLASS certificate: BL S1 d0 according to EN 13501-1.  It has a CE conformity certificate according to EN 14313.



## Wall bracket with crossbar MSH



Load capacity  
up to 200 kg



Ready for  
installation

### Description

Wall bracket for mounting outdoor units. Made of galvanized steel metal and painted with RAL 9016, highly resistant to weathering. Adjustable mounting distance of the outdoor unit. The mounting crossbar is equipped with level. Silence is obtained by dedicated vibration-damping devices on the shelves and adjustable articulated feet on the back of the arm that eliminate all vibrations transmitted by the unit.

### Technical drawing

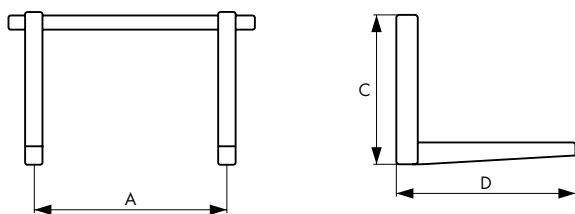

### Technical specifications

- ..... Crossbar with adjustable mounting
- ..... Foldable arms, slide-in mounting crossbar, painted (RAL 9016)
- ..... Adjustable vibration dampers
- ..... Wall bracket with spirit-level supplied
- ..... Equipped with wall fixing kit, vibration dampers
- ..... Load capacity: MSH 450 - 180 kg
- ..... MSH 550 - 200 kg
- ..... Quantity per box: 6 sets

### Dimensions [mm]:

Model	A	C	D	Weight	Load capacity
MSH 450	780	375	450	3,33 kg	180 kg
MSH 550	780	375	550	3,90 kg	200 kg



Load capacity up to 200 kg

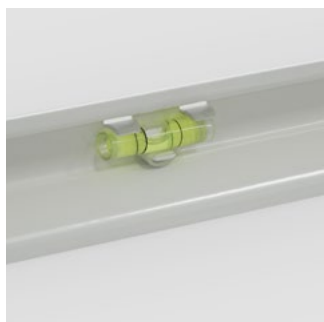

Leveling system for a quick installation



Reduced point load on the wall,  
height-adjustable rear swivel feet

# The condenser mounting MS



## Description

Handles for mounting outdoor units on walls. Foldable, equipped with a set of mounting studs and shock absorbers. Painted with epoxy-polyester paint providing a very high level of corrosion protection and good mechanical properties, finished in a white color RAL9002. Adjustable mounting distance of the outdoor unit. They have a TUV quality certificate.

## Technical drawing

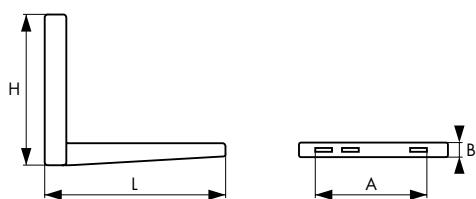

MS117 MS119 MS120

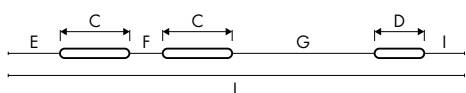

MS118

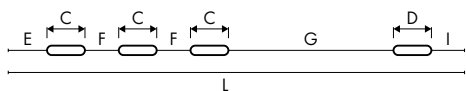

## Technical specifications [mm]

Model	L	H	A	B	C	D	E	F	G	I	Load capacity	Quantity per pallet
MS 117	465	375	375	50	60	78	70	12	165	20	140 kg	170
MS 118	550	375	464	50	60	62	70	12	200	14	140 kg	170
MS 119	550	490	445	60	100	100	95	28	120	16	200 kg	170
MS 120	420	375	336	50	60	38	70	12	165	15	140 kg	170



## The condenser mounting with a crossbar **MS**

### Description

Handles for mounting outdoor units on walls. Version with mounting crosshead fitted with a level. Foldable, equipped with a set of mounting studs and shock absorbers. Painted with epoxy-polyester paint providing a very high level of corrosion protection and good mechanical properties, finished in a white color RAL9002. Adjustable mounting distance of the outdoor unit. They have a TUV quality certificate.

### Technical drawing

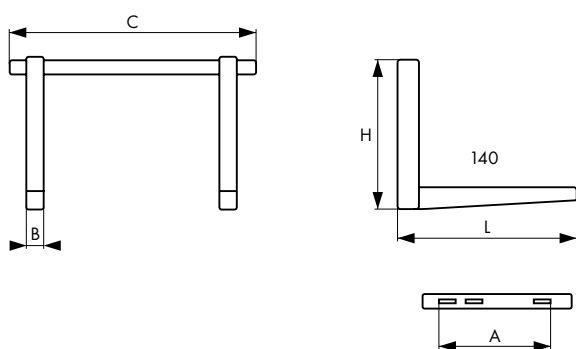

**MS230 MS253**

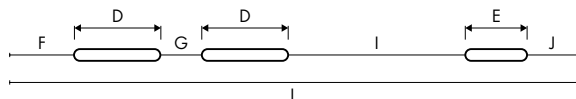

**MS450 MS657**

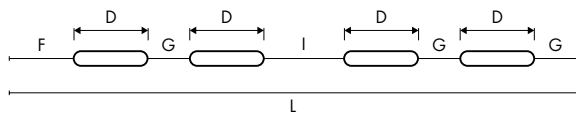

**MS223 MS257**

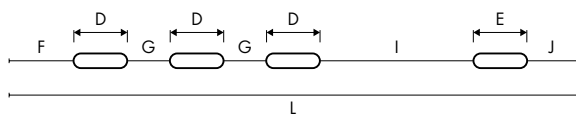

**MS258**

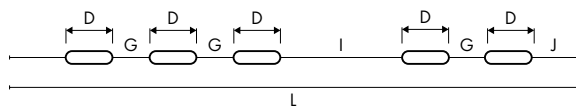

### Technical specifications [mm]

Model	L	H	A	B	C	D	E	F	G	I	J	Load capacity	Quantity per pallet
MS 230	420	375	334	50	800	60	38	70	12	165	15	140 kg	117
MS 450	450	320	370	50	800	60	-	60	12	165	-	120 kg	156
MS 253	465	375	375	50	800	60	78	70	12	165	20	140 kg	117
MS 657	550	320	450	50	800	60	-	45	20	170	-	120 kg	117
MS 257	550	375	464	50	800	60	62	70	12	200	14	140 kg	117
MS 223	550	375	464	50	1000	60	62	70	12	200	14	140 kg	117
MS 258	650	420	564	50	800	60	-	-	12	228	15	140 kg	108



## Wall bracket with cross-bar

### Galileo SGL 475



Load capacity  
up to 140 kg



Ready for  
installation

#### Description

The wall bracket for mounting external units. It is made of galvanised sheet metal and painted with RAL 9002 polyester powders highly resistant to weathering. The wall fixing bar with teeth allows anchoring and adjustment of the distance between the bracket support arms, without them sliding during the installation phase. The supports are arranged for mounting of the condensate drain pan. Silence is obtained by dedicated vibration-damping devices on the shelves and adjustable articulated feet on the back of the arm that eliminate all the vibrations transmitted by the unit. The wall bracket is tested and certified with a static weight equal to 1.5 times that declared. Available in a single pack complete with: adjustable and articulated back feet, vibration dampers, screws, wall fixing dowels.

#### Technical drawing

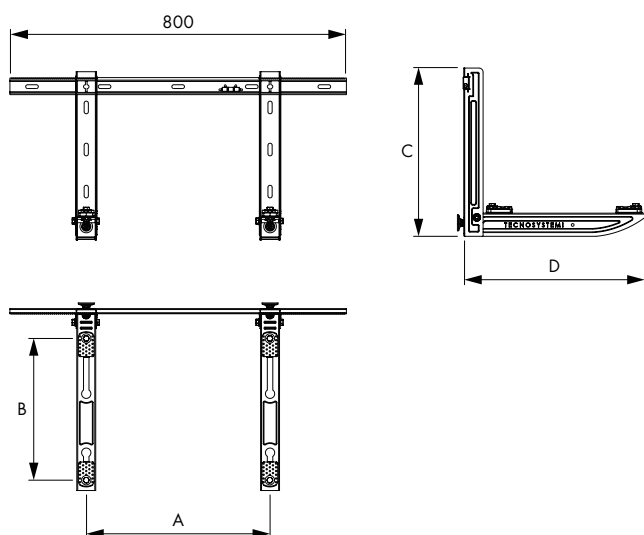

#### Technical specifications

- Made of electro-galvanised metal sheet
- Wall bracket with spirit level supplied
- External polyester in color RAL 9002
- Wall-mounted notched bar
- Ready for condensate drain pan
- Anti vibration "NO-SHOCK" dampers supplied
- Fixing plugs
- Adjustable rear swivel feet
- Load capacity 140 kg
- Light grey shock absorbers are mounted on the fan side (up to 60 kg)
- Dark grey shock absorbers are mounted on the compressor side (up to 120 kg)

#### Dimensions [mm]:

Model	A	B	C	D
Galileo SGL 475	440/745	180/385	400	475

Light grey shock absorbers are mounted on the fan side (up to 60 kg)



Dark grey shock absorbers are mounted on the compressor side (up to 120 kg)



No transmission of vibrations - "NO-SHOCK" vibration dampers



Maximum precision of setting - notched crossbar



Reduced point load on the wall - height-adjustable rear swivel feet



## Foot mount GENIUS 1200R HA



Load capacity  
up to 1200 kg



Adjustable  
angle 0-15°



Adjustable height  
200-300 mm

### Description

The revolutionary GENIUS 1200F HA vibration-damping floor support. Adjustable and articulated from 200 to 300 mm and 0-15°. Thanks to its material with high mechanical strength charged to glass and carbon, it is possible to support loads up to 1 200 kg. Equipped with two vibration dampers and height adjustment. It is recommended for the installation of air conditioners, small refrigeration units and heat pumps.

### Technical drawing

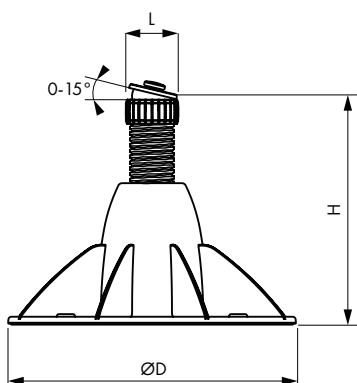

### Dimensions [mm]:

Model	ØD	H	L
Genius 1200R HA	330	200 - 300	60

### Technical specifications

- High mechanical strength (up to 1 200 kg)
- Anti-vibration rubber mat 10 mm
- 4 holes designed for floor fastening
- Packed in a set of 4
- Fastening pin with M10 screw
- Available in black



Integrated level



Adjustable angle 0-15°





## Foot mount **GENIUS 1200R**



Load capacity  
up to 1200 kg



Adjustable height  
170-210 mm



High quality  
material

### Description

The revolutionary GENIUS 1200R vibration-damping floor support. Adjustable and articulated from 170 to 210 mm. Thanks to its material with high mechanical strength charged to glass and carbon, it is possible to support loads up to 1 200 kg. Equipped with two vibration dampers and height adjustment. It is recommended for the installation of air conditioners, small refrigeration units and heat pumps.

### Technical drawing

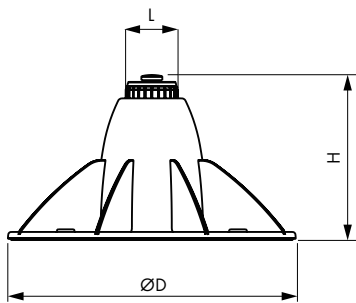

### Technical specifications

- High mechanical strength (up to 1200 kg)
- Anti-vibration rubber mat 10 mm
- 4 holes designed for floor fastening
- Packed in a set of 4
- Fastening pin with M10 screw
- Available in black

### Dimensions [mm]:

Model	ØD	H	L
Genius 1200R	330	170 - 210	60

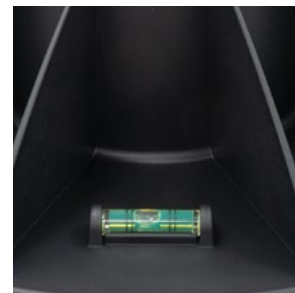

Integrated level



# Floor support Hercules



Load capacity  
up to 1200 kg



High quality  
material



Universal  
facilitating seat

## Description

The HERCULES vibration-damping floor supports have been designed to support high loads. Its load capacity is 1 200 kg. It is recommended for the positioning of large machines such as refrigeration units and air handling units. Packed in a set of 2 pieces.

## Technical drawing

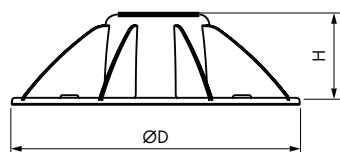

## Technical specifications

High mechanical strength (up to 1200 kg)

Anti-vibration rubber mat 10 mm

Packed in a set of 2

Available in black

## Dimensions [mm]:

Model	ØD	H
Hercules	330	110

## Universal facilitating seat

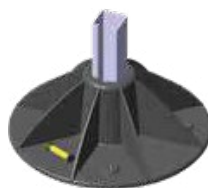

Profile 41x41 mm

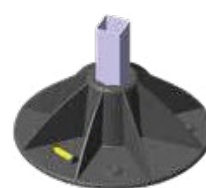

Pipe 40x40 mm



Round pipe Ø50 mm

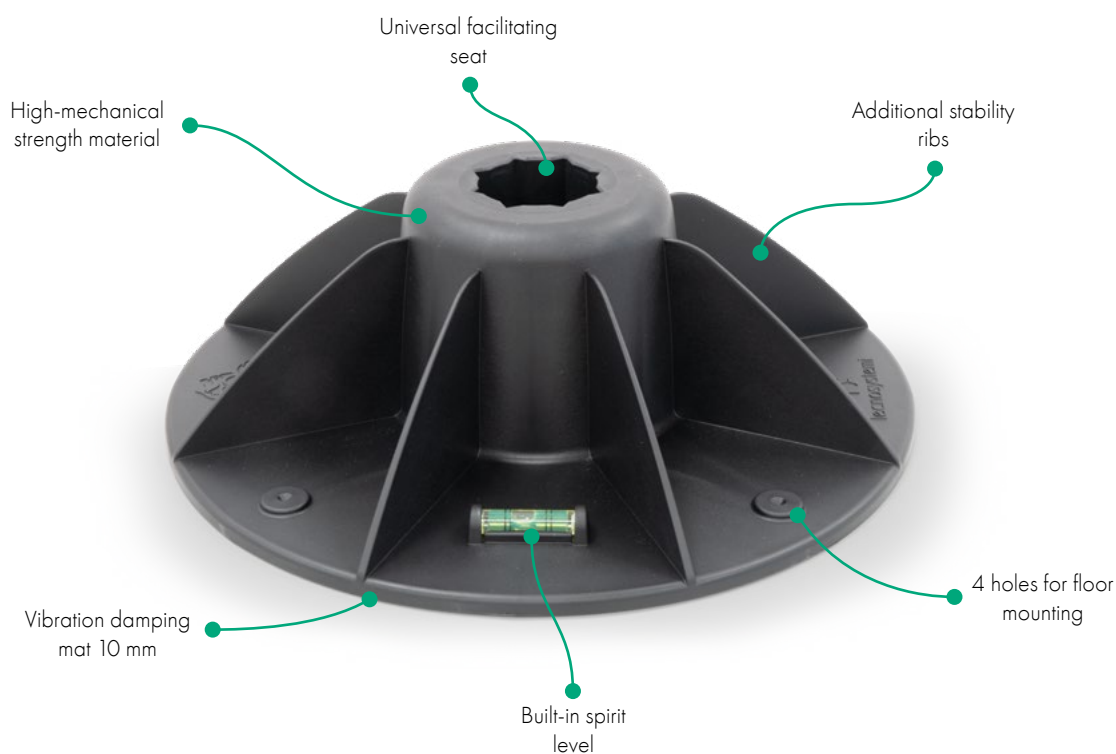





# Adjustable foot mount Genius 1000R IVORY



Load capacity  
up to 1000 kg



Adjustable height  
100-140 mm



High mechanical  
strength material

## Description

The GENIUS 1000R adjustable floor support is made for external air conditioning units or floor boilers. Height-adjustable, from 100 to 140 mm. It is made of material with high mechanical strength. Equipped with double vibration-dampers.

## Technical drawing

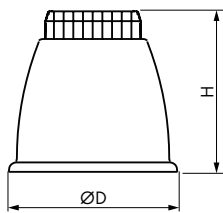

## Dimensions [mm]:

Model	ØD	H
Genius 1000R IVORY	105	100 - 140

## Technical specifications

- High mechanical strength
- Equipped with double vibration-dampers
- Mounting screw M8
- Available in IVORY color
- Load capacity up to 1000 kg
- Packed in a set of 4



Mounting screw M8



Adjustable height





## Foot mount Genius 1000 IVORY



Load capacity  
up to 1000 kg



Vibration  
absorber



High mechanical  
strength material

### Description

The GENIUS 1000 floor support for flat surfaces, is made for external air conditioning units or floor boilers, with fixed height of 90 mm. It is made of material with high mechanical strength. Equipped with double vibration-dampers.

### Technical drawing

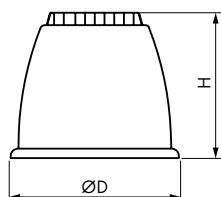

### Dimensions [mm]:

Model	ØD	H
Genius 1000 IVORY	105	90

### Technical specifications

- Quick fastening pin Ø10
- High mechanical strength
- Equipped with double vibration-dampers
- Available in IVORY color
- Load capacity up to 1000 kg
- Packed in a set of 4



Quick fastening pin



# Condensate pump EASY FLOW



Easy cleaning



Complete set  
installation



Quiet,  
21 dB(A)



Compact  
dimensions



Warranty  
2 years

## Description

Premium-class condensate pump of extremely compact size, housed in the indoor unit. Quick Plug & Play Installation. Recommended for both wall-mounted split air conditioners as well as commercial air conditioners.

Necessary when gravity drainage of condensate is not possible. Drains the condensate accumulating on the tray under the exchanger and, thanks to its design and equipment, will find use in the most difficult solutions

## 1. Floating body

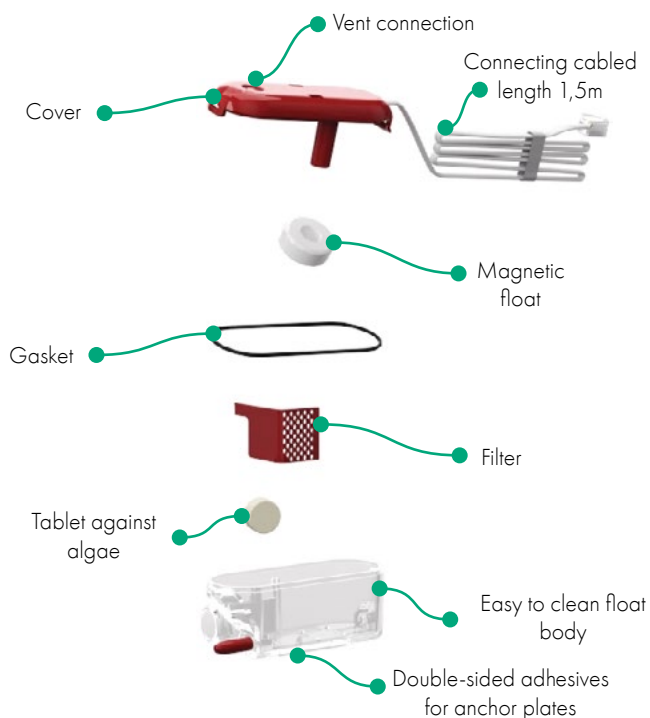

## Features

Transparent anti-algae float body

Compact size

Low noise level

Does not transmit vibration

Built-in thermal switch at 80°C

## Technical specifications

Max flow rate hourly from 11 to 15 l/h

Power supply 230V - 50Hz

Alarm contact C-NO/NC 8A

Protection rating IP20

Intake max 2 m vertical between floating body and pump

Transparent casing with disinfectant plug to prevent algae formation

Cover with gasket and vent hole

## Dimensions

Dimension tube 4 x 6 mm

Dimension pump width 97 x height 55 x depth 30 mm

Float body dimensions length 91 x height 39 x depth 34 mm

## 2. Pump

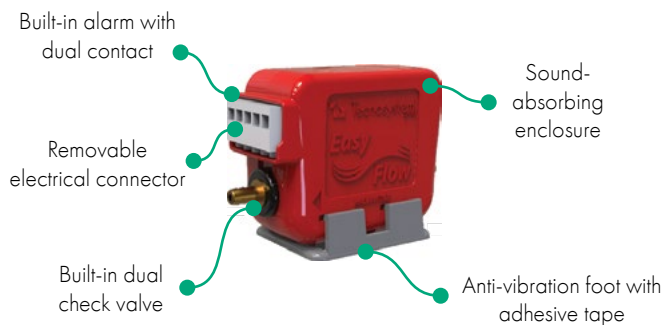

## Model EF 11 LT

For air conditioners up to 10 kW

Max. 8 m vertical delivery

Power consumption 19 W

Max noise level 21 [dB(A)]

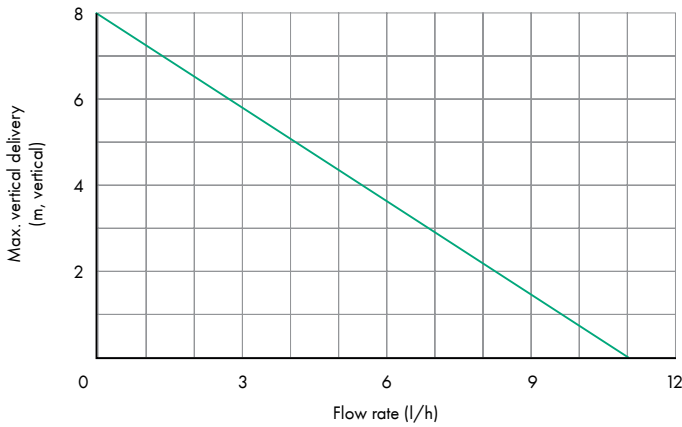

## Model EF 15 LT

For air conditioners up to 16 kW

Max. 10 m vertical delivery

Power consumption 19 W

Max noise level 25 [dB(A)]

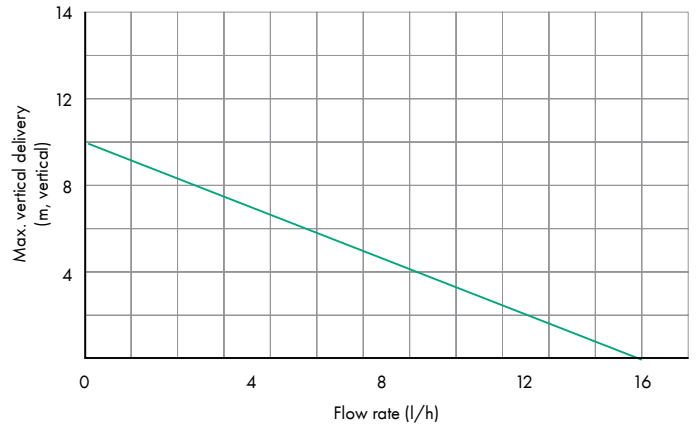

## Mounting possibilities

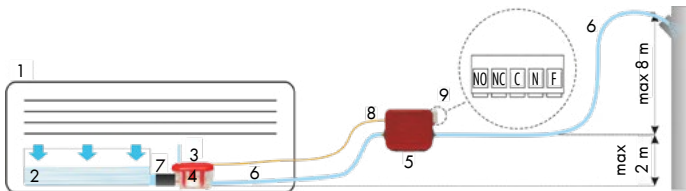

- |                                      |                                |
|--------------------------------------|--------------------------------|
| 1. Indoor unit                       | 5. Pump                        |
| 2. Drip tray                         | 6. Connection hose 1 m         |
| 3. Vent connection                   | 7. Connecting sleeve in rubber |
| 4. Transparent anti-algae float body | 8. Electric cable              |
|                                      | 9. Integrated connector        |

### 1. Inside of the indoor unit:

a) Both the floating body and the pump next to the drip tray

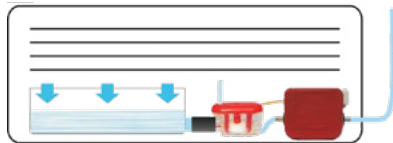

b) Floating body directly on the drip tray, pump next to

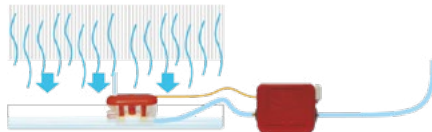

View video



In the indoor unit

### 2. Floating body and pump outside the unit

a) Horizontal layout

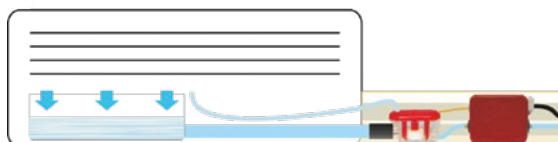

b) Vertical layout

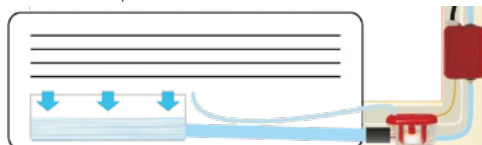

View video

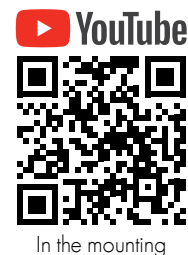

In the mounting trough

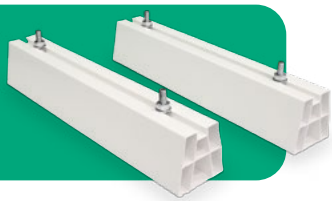

## PVC base for condenser ADF

### Description

Base for mounting outdoor units on a horizontal ground. Made of PVC plastic. The cellular structure guarantees adequate stiffness and shock absorption. Wide temperatures range from -20°C to 60°C. Adjustable damper spacing. Equipped with a set of mounting studs, screws.

### Technical specifications

Model	Length [mm]	Height [mm]	Width [mm]	Load capacity [kg]	Quantity per box [pcs]
PVC ADF 350	350	80	80	120	6
PVC ADF 450	450	80	80	120	6
PVC ADF 1000	1000	80	80	120	1

## Floor mounts SP510



### Description

Conical base for installation with air conditioning units. Made of PVC, color RAL 1013.

### Technical specifications

Model	Dimensions [mm]	Load capacity [kg]	Quantity per box [pcs]
SP510	105x55x95	150	4



## End cap for PVC base for condenser PVC342TS

### Technical specifications

Model	Usage	Quantity per box [set 4 pcs.]
PVC342TS	for ADF 350, ADF 450, ADF 1000	1

## Anti-vibration feet FVDCO M8



### Description

Anti-vibration feet for mounting with external units of air conditioners or other ventilation devices.

### Technical specifications

Model	Height [mm]	Length [mm]	Load capacity [kg]	Quantity per box [pcs]
FVDCO M8	17 - 45	48	150	4



## Rubber base RB

### Description

Base for mounting outdoor units on a horizontal ground. Made of rubber. The cellular structure guarantees adequate stiffness and shock absorption. Wide temperatures range from -20°C to 60°C. Adjustable damper spacing. Equipped with a set of mounting studs, screws.

### Technical specifications

Model	Length [mm]	Height [mm]	Width [mm]	Load capacity [kg]	Quantity per box [pcs]
RB 400	400	95	130	180	90
RB 600	600	95	130	300	60

## Reducing connector for condensate drain CCSR



### Description

Reducing coupling for condensate drain. Used to connect condensate lines or reduce the diameter of the drain system. The fittings are flexible on one side and rigid on the other.

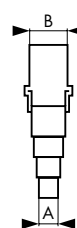

### Technical specifications

Model	A [mm]	B [mm]	Colour	Quantity per box [pcs.]
CCSR 16	14/16/18/20	16	yellow	300
CCSR 18	14/16/18/20	18	red	300
CCSR 20	14/16/18/20	20	blue	300
CCSR 25	14/16/18/20	25	green	300
CCSR 32	14/16/18/20	32	grey	300



## Corrugated condensate pipe TU

### Description

Flexible drain pipe. Quick and easy installation without the need for fittings. Made of plastic. Helical notching prevents bending of the section.

### Technical specifications

Model	Diameter [mm]	Length [m]
TU16/30	16	30
TU18/30	18	30



## Reinforced condensate pipe

### Description

Flexible drain pipe. Quick and easy installation without the need for fittings. Made of plastic and additionally reinforced.

### Technical specifications

Model	Inner diameter [mm]	Outer diameter [mm]	Length [m]
Reinforced condensate pipe	6	9	30



## Condensate pipe

### Description

Flexible drain pipe. Quick and easy installation without the need for fittings. Made of plastic.

### Technical specifications

Model	Inner diameter [mm]	Outer diameter [mm]	Length [m]
Condensate pipe	4	6	10
Condensate pipe	4	6	100
Condensate pipe	6	9	50

## Condenser ball trap HL136



### Description

Condenser trap with water and mechanical anti-odor lock. DN40 horizontal condenser trap with 5/4" connection (DN32) or D 12 - 18 mm (for smooth hoses) vertical or horizontal, water aspiration (60 mm) with mechanical anti-odor closure and cleaner. For air-conditioning equipment, chimney installations and the like.

### Technical specifications

Model	Diameter	Throughput [l/s]	Weight [kg]
HL136	DN40 x 5/4"	0,37	0,23

## Vertical/horizontal trap



### Description

Horizontal/vertical air conditioning condensate trap with 16, 18, 20 mm connection, made of PVC. It has an inspection hole for possible cleaning of the trap. It prevents the penetration of unpleasant odours from the sewerage.

### Technical drawing

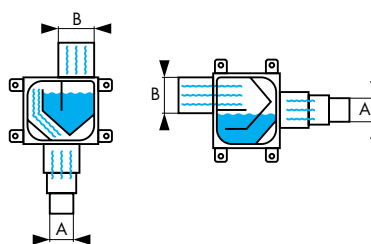

### Dimensions [mm]

A	B
16, 18	20



## Flush-mounted trap HL138

### Description

Flush-mounted trap with a ball to prevent unpleasant odours from the sewer. The adjustable mounting cover allows for installation at different wall thickness, and thanks to the rubber reduction, hoses with diameters from 20 to 32 mm can be connected to the trap.

### Technical drawing

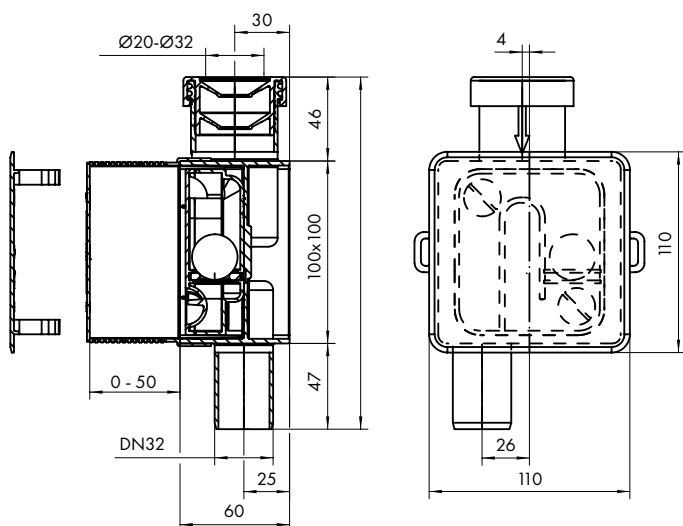

### Technical specifications

Material	PP/ABS	Weight	0,28 kg
Diameter	DN32	Inflow	Ø 20 - 30 mm
Throughput	120 l/h	Regulations	DIN19541



## Condensate pump MINI ORANGE

### Description

The MINI Orange condensate pump is ideal for small commercial and domestic air conditioning devices with a maximum power of 16 kW (54 kBTU/h). Plug&Play device with anti syphon system, with a spare immersion tank as standard.

### Technical drawing

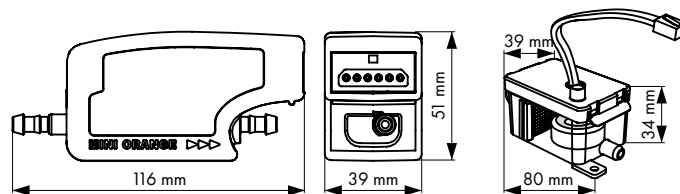

### Technical specifications

Power supply	230 V, 0,11A, 16W, 50/60Hz
Maximum recommended lifting height	10 m
Noise level (at a distance of 1m)	21 dB
Protection class IP	IP21
Overheating protection	Yes
Self-priming	Yes
Maximum flow rate	12 L/godz.
Maximum suction height	2 m
Maximum water temperature	40°C / 104°F
Discharge hose	6 mm ID
Safety switch	3,0A Normally closed
Electronic components encapsulated in resin	Yes

## Fungicide fluid Nanoclean Air



### Description

Multi-purpose cleaning and disinfection product for surfaces, medical equipment and tools in the form of a concentrate with the smell of lavender or orchid. Capacity 1l.

## Biocidal foam Nanoclean Air Aerosol



### Description

Biocidal NanoClean Air foam (aerosol) for cleaning and disinfection of surfaces and air conditioning ducts, ventilation in buildings and vehicles with a capacity of 400 ml.





## Cleaner and degreaser **ACTIVE Concentrate**

### Description

A refreshing cleaner for cleaning, washing and degreasing. Created to eliminate bacteria and fungi, Active concentrate cleans, degreases and eliminates odours. Ideal for a regular maintenance of air conditioning and refrigeration equipment. Used as a concentrate or diluted with water. Capacity 5 L.



## Cleaner and degreaser **ACTIVE Foam**

### Description

A product for cleaning, washing and degreasing. Highly cleaning, active foam excellent for vertical surfaces, adhering to the cleaned surface. Capacity 500 ml.



## Cleaner and degreaser **POWER Concentrate**

### Description

Power concentrate is a versatile, powerful, alkaline and non-corrosive agent designed for professional cleaning of refrigeration and air conditioning equipment, only outdoor units. Used as a concentrate or diluted with water. Capacity 5 L.



## Trough and mounting fittings PVC



### Description

Installation trough used for air conditioning installation. They allow you to mask cooling lines and condensate drains in an aesthetic way. PVC material in two colours Optimal Duct – pure white and ARTICA DUCT - creamy white. Increased resistance for UV radiation and mechanical damage. Wide temperature range -20°C +60°C.



### Installation trough PVC

**ODF 80**  
**ADF 80**

### Technical drawing

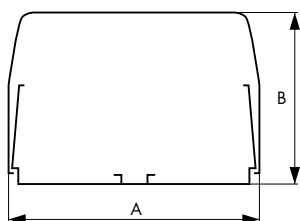

### Technical specifications [mm]

Model	A	B	Length	Quantity in the box [pcs.]
ODF 80	80	60	2000	8
ADF 80	80	60	2000	8

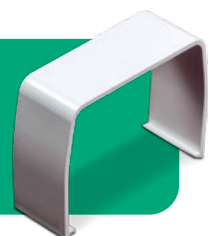

### Connecting strap PVC, tray connector

**ODC 80**  
**CLC 80**

### Technical specifications [mm]

Model	Width	Height	Quantity in the box [pcs.]
ODC 80	80	60	10
CLC 80	80	60	10

### Trough end cap PVC

**ODEC 80**  
**CLEC 80**

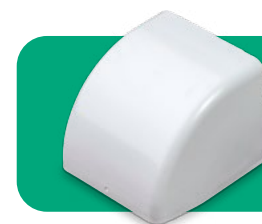

### Technical specifications [mm]

Model	Width	Height	Quantity in the box [pcs.]
ODEC 80	80	60	10
CLEC 80	80	60	10

### Wall-mounted cover PVC

**ODWC 80**  
**CLWC 80**



### Technical specifications [mm]

Model	Width	Height	Quantity in the box [pcs.]
ODWC 80	80	60	10
CLWC 80	80	60	10

### Inner corner PVC

**ODIC 80**  
**CLIC 80**



### Technical specifications [mm]

Model	Width	Height	Quantity in the box [pcs.]
ODIC 80	80	60	10
CLIC 80	80	60	10



External corner PVC  
**ODCO 80**  
**CLCO 80**

Technical specifications [mm]

Model	Width	Height	Quantity in the box [pcs.]
ODCO 80	80	60	10
CLCO 80	80	60	10

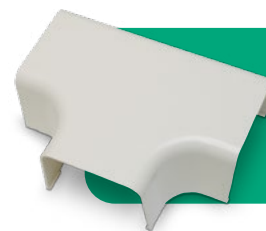

T-piece PVC  
**ODTJ 80**  
**CLT 80**

Technical specifications [mm]

Model	Width	Height	Quantity in the box [pcs.]
ODTJ 80	80	60	10
CLT 80	80	60	10

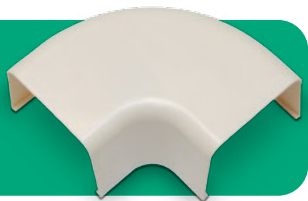

Mounting bend PVC  
**ODFE 80**  
**CLFE 80**

Technical specifications [mm]

Model	Width	Height	Quantity in the box [pcs.]
ODFE 80	80	60	10
CLFE 80	80	60	10



Rosette  
**ODWR 80**  
**CLFR 80**

Technical specifications [mm]

Model	Width	Height	Quantity in the box [pcs.]
ODWR 80	80	60	10
CLFR 80	80	60	10









## Round ventilation fittings system

- Wide range round and rectangular fittings.
- Fittings with out and with gasket in the highest tightness class "D".
- Rounded edges facilitate quick and safe installation.



## Fans

- Domestic and industrial fans.
- Kitchen exhaust fans.
- Simple and reliable design.
- High-quality materials.



## Electric heaters | Controllers

- Electric heaters for round and rectangular ducts.
- Wide range of control automation.
- High-quality.



## Ventilation products

- Flexo System - complete air distribution system for houses.
- Ventilation ducts.
- Mounting and production accessories.
- Valves and anemostats.



## Accessories for air conditioning

- High-quality insulated copper pipe.
- Wide range wall brackets.
- Installation trough and fittings.
- Mounting and production accessories.
- Condensate pumps.

Distributor:

**Ventia Sp z o.o.**  
Słowikowskiego 81  
05-090 Raszyn, Poland  
TEL. (+48 22) 841 11 65  
info@ventia.pl

**www.havaco.pl**